

Алматы (7273)495-231
Ангарск (3955)60-70-56
Архангельск (8182)63-90-72
Астрахань (8512)99-46-04
Барнаул (3852)73-04-60
Белгород (4722)40-23-64
Благовещенск (4162)22-76-07
Брянск (4832)59-03-52
Владивосток (423)249-28-31
Владикавказ (8672)28-90-48
Владимир (4922) 49-43-18
Волгоград (844)278-03-48
Вологда (8172)26-41-59
Воронеж (473)204-51-73
Екатеринбург (343)384-55-89

Ижевск (3412)26-03-58
Иваново (4932)77-34-06
Иркутск (395)279-98-46
Казань (843)206-01-48
Калининград (4012)72-03-81
Калуга (4842)92-23-67
Кемерово (3842)65-04-62
Киров (8332)68-02-04
Коломна (4966)23-41-49
Кострома (4942)77-07-48
Краснодар (861)203-40-90
Красноярск (391)204-63-61
Курск (4712)77-13-04
Курган (3522)50-90-47
Липецк (4742)52-20-81

Магнитогорск (3519)55-03-13
Москва (495)268-04-70
Мурманск (8152)59-64-93
Набережные Челны (8552)20-53-41
Нижний Новгород (831)429-08-12
Новокузнецк (3843)20-46-81
Ноябрьск (3496)41-32-12
Новосибирск (383)227-86-73
Ноябрьск (3496)41-32-12
Омск (3812)21-46-40
Орел (4862)44-53-42
Оренбург (3532)37-68-04
Пенза (8412)22-31-16
Петрозаводск (8142)55-98-37
Псков (8112)59-10-37

Пермь (342)205-81-47
Ростов-на-Дону (863)308-18-15
Рязань (4912)46-61-64
Самара (846)206-03-16
Саранск (8342)22-96-24
Санкт-Петербург (812)309-46-40
Саратов (845)249-38-78
Севастополь (8692)22-31-93
Симферополь (3652)67-13-56
Смоленск (4812)29-41-54
Сочи (862)225-72-31
Ставрополь (8652)20-65-13
Сыктывкар (8212)25-95-17
Сургут (3462)77-98-35
Тамбов (4752)50-40-97

Тверь (4822)63-31-35
Тольяти (8482)63-91-07
Томск (3822)98-41-53
Тула (4872)33-79-87
Тюмень (3452)66-21-18
Улан-Удэ (3012)59-97-51
Ульяновск (8422)24-23-59
Уфа (347)229-48-12
Хабаровск (4212)92-98-04
Чебоксары (8352)28-53-07
Челябинск (351)202-03-61
Череповец (8202)49-02-64
Чита (3022)38-34-83
Якутск (4112)23-90-97
Ярославль (4852)69-52-93

Киргизия (996)312-96-26-47

Россия (495)268-04-70

Казахстан (772)734-952-31

<https://martellato.nt-rt.ru> || mot@nt-rt.ru

КАТАЛОГ изделий для оформления тортов



INTERPRETAZIONE, CREATIVITÀ E TANTE IDEE
AVVINCENTI CHE COINVOLGONO IL PASTICCIERE
ARTIGIANO, LA CAKE DESIGNER E LA CASALINGA
APPASSIONATA TRASFORMANDOLI IN VERI
ARTISTI IN GRADO DI PROPORRE DOLCI DI
INCANTEVOLE QUALITÀ.

MARTELLATO IMPORTA L'ARTE E LA FA
PROPRIA ATTINGENDO DAL MONDO DELLA
SUGAR ART ALCUNE MERAVIGLIOSE TECNICHE
DA RIADATTARE ALLE REALI ESIGENZE DEL
PASTICCIERE PROFESSIONISTA.

INTERPRETATION, CREATIVITY AND A LOT OF
EXCITING IDEAS THAT INVOLVE THE ARTISAN
PASTRY CHEF, THE CAKE DESIGNER AND
PASSIONATE HOUSEWIFE TRANSFORM THEM INTO
REAL ARTISTS ABLE TO OFFER LOVELY CAKES.

MARTELLATO LOVES ART AND MAKES IT HIS
OWN, BY DRAWING FROM THE WORLD OF
SUGAR ART SOME WONDERFUL TECHNIQUES,
AND READJUST THEM TO THE REAL NEEDS OF THE
PROFESSIONAL PASTRY CHEF.



STAMPI STANTUFFO PER FIORI Flower plunger cutters	2
VENATORI PER FOGLIE E PETALI Leaf and petal veiners	9
CUTTER PER FIORI Flower cutters	10
PISTILLI E ACCESSORI Stamens and accessories	14
TEGLIE E CONTROSTAMPI Trays and flower formers	14
STAMPI A STANTUFFO PER DECORAZIONI Decoration plunger cutters	16
STAMPI PER BISCOTTONI Cookie moulds	22
PASTE E TAPPETI DECORO Mixtures and mats	26
STENCIL PER GHIACCIA Icing stencils	32
STENCIL PER AEROGRAFIA Airbrush stencils	36
AEROGRAFI E ACCESSORI Airbrush and accessories	50
TAPPETI DECORO IN RILIEVO Relief decoration mats	52
ATTREZZI DECORO Decoration tools	53
STENDIPASTA Rolling machine	61
BOCCHETTE DECORAZIONI Piping tips	62
PASTA ZUCCHERO E COLORANTI ALIMENTARI Sugar paste and food colours	66
ACCESSORI PER DOLCI MONUMENTALI Accessories for monumental cakes	72
ALZATINE IN PLEXIGLASS Cake stands	75
PIROTTINI IN PLASTICA Plastic cups	75
INDICE ARTICOLI IN ORDINE ALFABETICO Items index in alphabetical order	76

STAMPI STANTUFFO PER FIORI FLOWER PLUNGER CUTTERS



Dalia - Dahlia

COD. 40-W206S

Set 2 pcs Ø90mm - Ø65 mm

Controstampo Dalia Dahlia flower formers

COD. 40-W206C

380x280mm

5 teglie per petali - 5 Trays for petals

COD. 40-W206C1

380x280mm

1 teglia per petali - 1 Tray for petals

Con una teglia si asciugano i petali necessari per una Dalia - vedi pg 14

With a tray you can dry the exact number of petals for one Dahlia - See pg 14



Tulipano - Tulip

COD. 40-W194S

Set 2 pcs 27x46mm - 66x37mm

Controstampo Tulipano Tulip flower formers

COD. 40-W194C

380x280mm

5 teglie per petali - 5 Trays for petals

COD. 40-W194C1

380x280mm

1 teglia per petali - 1 Tray for petals

Con una teglia si asciugano i petali necessari per un Tulipano - vedi pg 14

With a tray you can dry the exact number of petals for one Tulip - See pg 14

Supporto Asciugatura Tulip flower formers

COD. 40-W194B

Ø 100 h90mm

Kit 5 supporti / 5 Flowers formers



Venatore - Veiner

COD. 40-WF009

66x39mm

Venatore in silicone per petali

Silicon veiner for petals



Margherite - Daisies

COD. 40-W192S

Set 2 pcs Ø48mm - Ø62 mm



Controstampo Daisy flower formers

COD. 40-W192C

Ø 55 h30mm

Kit 4 controstampi / 4 Flowers formers





Ibiscus

COD. 40-W0515

Set 4 pcs - 19x48mm - 27x70mm - 35x90mm - 44x110mm



Venatore - Veiner

COD. 40-WF009

66x39mm

Venatore in silicone per petali
Silicon veiner for petals



Controstampo Ibiscus Ibiscus flower formers

COD. 40-W027

Ø 115 h55mm

Kit 4 controstampi / 4 Flowers formers



Giglio - Lilium

COD. 40-W0495

Set 4 pcs

17x48mm - 24x70mm - 32x90mm - 39x110mm



Venatore - Veiner

COD. 40-WF012

85x34mm

Venatore in silicone per petali
Silicon veiner for petals



Controstampo Giglio Lilium flower formers

COD. 40-W055

Ø 160 h60mm

Kit 4 controstampi / 4 Flowers formers



Surfinia

COD. 40-W193S

Set 2 pcs 66x60 - 38x52 mm



Controstampo Surfinia Surfinia flower formers

COD. 40-W193C

Ø 75 h50mm

Kit 4 controstampi / 4 Flowers formers



Venatore - Veiner

COD. 40-WF009

66x39mm

Venatore in silicone per petali
Silicon veiner for petals





Bucaneve - Snowdrop

COD. 40-W204S

Set 2 pcs Ø65mm - Ø45 mm



Controstampo - Snowdrop flower formers

COD. 40-W204C

Kit 4 controstampi cono e 1 teglia 160x80mm
4 Flowers cones formers - 1 tray 160x80mm

Kit Bucaneve - Kit Snowdrop

COD. 40-W204K

Kit 2 stampi stantuffo - 4 controstampi cono - 1 teglia 160x80mm
Kit 2 pcs plunger cutter - 4 Flowers cones formers - 1 tray 160x80mm



Stella Alpina - Edelweiss

COD. 40-W205S

Set 2 pcs Ø82mm - Ø65 mm



Controstampo Edelweiss flower formers

COD. 40-W192C

Ø 55 h30mm
Kit 4 controstampi / 4 Flowers formers



Peonia grande Big Peony

COD. 40-W2075

Set 2 cutter
Ø48mm - Ø62 mm

Teglie Alveolari Alveolar Tray

Ideali per grandi produzioni di fiori.
Teglie alveolari 60x40cm/ 30x40cm
Ideal for largest production of flower.
Alveolar tray 60x40cm/ 30x40cm
(vedi pg 14 - See pg 14)





Stella di Natale Poinsettia

COD. 40-W188S

Set 4
17x32 - 29x52 - 31x62 - 37x60 mm



Controstampo Flower formers

COD. 40-W189

Ø 126 h35mm
Kit 4 controstampi / 4 Flowers formers



Venatore - Veiner

COD. 40-WF005

58x25mm
Venatore in silicone per petali
Silicon veiner for petals



VENATORI PER FOGLIE E PETALI LEAF AND PETAL VEINERS

Stampo **venatore** in silicone e **cutter** in plastica per venare petali e foglie.
Veiner silicon mould and plastic **cutter** to veiner petals and leaves.



COD. 40-WF001

81x55mm

Kit Cutter e Venatore per foglie generiche.
Cutter and Veiner kit for generic leaves.
Ideale per venare anche i petali di: Anthurium.
Ideal also for the petals of: Anthurium.



COD. 40-WF002

55x46mm

Kit Cutter e Venatore per foglie di:
Orchidea Cinese.
Cutter and Veiner kit for leaves:
Cinese Orchid.



COD. 40-WF003

110x97mm

Kit Cutter e Venatore per foglie acquatiche.
Cutter and Veiner kit for aquatic leaves.



COD. 40-WF004

105x55mm

Kit Cutter e Venatore per foglie generiche.
Cutter and Veiner kit for generic leaves.



COD. 40-WF005

58x25mm

Kit Cutter e Venatore per foglie di: Girasole e Petunia.
Cutter and Veiner kit for leaves: Sunflower and Petunia.
Ideale anche per venare i petali di: Stella di Natale.
Ideal also for the petals of: Poinsettia.



COD. 40-WF006

83x46mm

Kit Cutter e Venatore per foglie di: Ortensia.
Cutter and Veiner kit for leaves: Hydrangea.



COD. 40-WF007

160x69mm

Kit Cutter e Venatore per foglie di:
Calla.
Cutter and Veiner kit for leaves:
Calla Lily.



COD. 40-WF008

89x31mm

Kit Cutter e Venatore per foglie di: Giglio e Peonia.
Cutter and Veiner kit for leaves: Liliun or Peony.
Ideale anche per venare i petali di: Orchide Panse,
Orchidea 3 Petali
e Orchidea Cymbidium.
Ideal also for the petals of: Pansy Orchid, 3 Petal Orchid
and Cymbidium Orchid.



COD. 40-WF009

66x39mm

Kit Cutter e Venatore per foglie generiche.
Cutter and Veiner kit for generic leaves.
Ideale per venare anche i petali di:
Orchide Panse, Orchidea 3 Petali, Orchidea Cymbidium,
Tulipano, Ibisus, Rosa e Surfinia.
Ideal also for the petals of:
Pansy Orchid, 3 Petal Orchid, Cymbidium Orchid, Tulip,
Ibiscus, Rose and Surfinia.



COD. 40-WF010

74x69mm

Kit Cutter e Venatore per foglie di: Edera.
Cutter and Veiner kit for leaves: Ivy.



COD. 40-WF011

85x34mm

Kit Cutter e Venatore per foglie di: Margherita.
Cutter and Veiner kit for leaves: Daisy.



COD. 40-WF012

85x34mm

Kit Cutter e Venatore per foglie generiche.
Cutter and Veiner kit for generic leaves.
Ideale per venare anche i petali di:
Giglio e Giglio Tigrato.
Ideal also for the petals of: Lily and Tiger Lily.



Peonia Piccola - Small Peony

COD. 40-W007

Cutter Peonia - Peony cutter
40x40mm

Comporre i fiori usando teglie alveolari: EFT02-EFT10
Use the alveolar trays to create flower: EFT02-EFT10



Girasoli - Sunflowers

COD. 40-0304

Set 2 cutter Girasole grande e piccolo
Set 2 big and small Sunflower cutter
Ø 80mm - Ø 70mm

Comporre i fiori usando teglie alveolari:
grande EFT02-EFT10 piccolo EFT04-EFT11
Use the alveolar tray to create flower:
big EFT02-EFT10 small EFT04-EFT11



Farfalle - Butterflies

COD. 40-1314

Set 2 cutter Farfalla grande e piccola
Set 2 big and small Butterfly cutter
50x38mm - 40x30mm

Per comporre la farfalla utilizzare la teglia alveolare EFT07
Use the alveolar tray EFT07 oo create the butterfly



Margherite - Daisies

COD. 40-0506

Set 2 cutter Margherita grande e piccola
Set 2 big and small Daisy cutter
Ø 80mm - Ø 70mm

Comporre i fiori usando teglie alveolari:
grande EFT02-EFT10 piccolo EFT04-EFT11
Use the alveolar tray to create flower:
big EFT02-EFT10 small EFT04-EFT11



Anthurium

COD. 40-W003

Cutter Anthurium
67x67mm

Comporre i fiori usando teglie alveolari: EFT02-EFT10
Use the alveolar trays to create flower: EFT02-EFT10



Calle - Calla Lilies

COD. 40-1112

Set 2 cutter Calla grande e piccola
Set 2 big and small Calla Lily cutter
76x55mm - 62x45mm

Comporre i fiori usando teglie alveolari: EFT02-EFT10
Use the alveolar trays to create flower: EFT02-EFT10

Rose

COD. 40-W028

Set 3 cutter petali rosa
Set 3 petals rose cutter
32x29mm - 39x34mm - 47x40mm



Corolle Rosa Rose Corollas

COD. 40-W001

Set 3 cutter corolla rosa
Set 3 corolla rose cutter
Ø21mm - Ø34mm - Ø40mm



Quadrifogli Four leaved clovers

COD. 40-0910

Set 2 cutter Quadrifoglio grande e piccola
Set 2 big and small Four leaved clover cutter
Ø 55mm - Ø 45mm

Comporre i fiori usando teglie alveolari: EFT05-EFT12
Use the alveolar trays to create flower: EFT05-EFT12



Six petals flowers

COD. 40-0708

Set 2 cutter Fiore a sei petali grande e piccolo
Set 2 big and small Six petals flower cutter
Ø 75mm - Ø 65mm

Comporre i fiori usando teglie alveolari:
grande EFT02-EFT10 piccolo EFT04-EFT11
Use the alveolar tray to create flower:
big EFT02-EFT10 small EFT04-EFT11



Foglie Zigrinate - Serrated leaves

COD. 40-0015

Set 2 cutter Foglia grande e piccola
Set 2 big and small Leaf cutter
55x35mm - 45x26mm

Comporre le foglie usando teglie alveolari: EFT07-EFT13
Use the alveolar trays to create leaves: EFT07-EFT13



Foglie Lisce - Smooth leaves

COD. 40-0016

Set 2 cutter Foglia grande e piccola
Set 2 big and small Leaf cutter
55x35mm - 45x26mm

Comporre le foglie usando teglie alveolari: EFT07-EFT13
Use the alveolar trays to create leaves: EFT07-EFT13





Gerbere - Gerberas

COD. 40-0102

Set 2 cutter Gerbera grande e piccola

Set 2 big and small Gerbera cutter

Ø 90mm - Ø 70mm

Comporre i fiori usando teglie alveolari:

grande EFT02-EFT10 piccolo EFT04-EFT11

Use the alveolar tray to create flower:

big EFT02-EFT10 small EFT04-EFT11



Giglio Tigrato - Tiger Lily

COD. 40-W002

Cutter Giglio Tigrato - Tiger Lily cutter

85x34mm

Utilizzare il controstampo cod. 40-W055 per comporre il fiore

Use the sugar flower formers cod. 40-W055 to create your flower



Cosmos

COD. 40-W005

Cosmos cutter

35x20mm

Comporre i fiori usando teglie alveolari: EFT02-EFT10

Use the alveolar trays to create flower: EFT02-EFT10



Garofani - Carnations

COD. 40-W008

Set 3 cutter Garofano - Set 3 Carnation cutter

Ø 40mm - Ø 50mm - Ø 60mm

Comporre i fiori usando teglie alveolari:

grande EFT02-EFT10 piccolo EFT04-EFT11

Use the alveolar tray to create flower:

big EFT02-EFT10 small EFT04-EFT11



Petunie - Petunias

COD. 40-W029

Set 3 cutter Petunia - Set 3 Petunia cutter

Ø 21mm - Ø 36mm - Ø 41mm

Comporre i fiori usando il controstampo cod. 40-W082

Use the sugar flower formers cod. 40-W082 to create your flower



Omino Marzapane Gingerbread Man

COD. 40-WB001

Cutter Omino Marzapane - Gingerbread man cutter

69x90mm

Orchidea Pansè Pansy Orchid

COD. 40-W030

Kit 3 cutter per Orchidea Pansè
Kit 3 cutter for Pansy Orchid
72x72mm - 96x66mm - 57x31mm

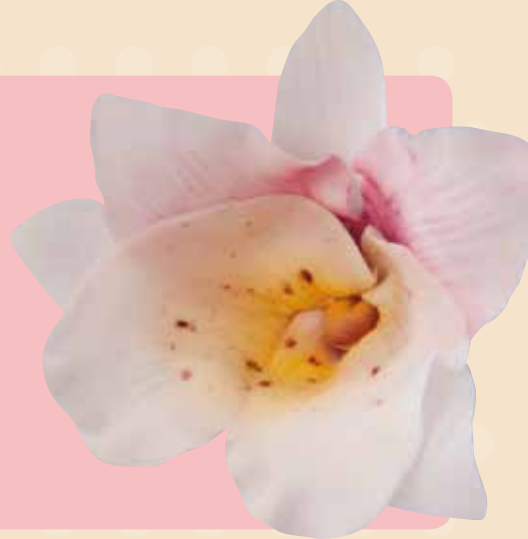

Utilizzare il controstampo cod. 40-W053 per comporre il fiore
Use the sugar flower formers cod. 40-W053 to create your flower

Orchidea Cymbidium Cymbidium Orchid

COD. 40-W045

Kit 3 cutter per Orchidea Cymbidium
Kit 3 cutter for Cymbidium Orchid
85x35mm - 65x35mm - 41x39mm



Utilizzare il controstampo cod. 40-W054 per comporre il fiore
Use the sugar flower formers cod. 40-W054 to create your flower

Orchidea a tre petali Three petals Orchid

COD. 40-W006

Kit 3 cutter per Orchidea tre petali
Kit 3 cutter for three petals Orchid
105x85mm - 48x48mm - 60x30mm



Utilizzare il controstampo cod. 40-W053 per comporre il fiore
Use the sugar flower formers cod. 40-W053 to create your flower

Orchidea Cinese Grande Big Chinese Orchid

COD. 40-W044

Kit 3 cutter for Big Chinese Orchid
75x35mm - 51x55mm - 66x20mm

Orchidea Cinese Piccola Small Chinese Orchid

COD. 40-W009

Kit 3 cutter for Small Chinese Orchid
55x20mm - 37x40mm - 47x15mm



Utilizzare il controstampo cod. 40-W053 per comporre il fiore
Use the sugar flower formers cod. 40-W053 to create your flower

PISTILLI E ACCESSORI STAMENS AND ACCESSORIES



COD. 40-W039

Gambo per fiore - Floral wire
1,3mm - pack 100 gr

COD. 40-W040

Gambo per fiore - Floral wire
0,9mm - pack 100 gr

COD. 40-W041

Gambo per fiore - Floral wire
0,6mm - pack 100 gr

COD. 40-W046

Rotolo nastro verde coprigambo
Green roll to cover stems flowers



COD. 40-W114

Pistilli piccoli perlati bianchi
Stamen small pearl-white



COD. 40-W115

Pistilli medi gialli
Stamen medium yellow



COD. 40-W116

Pistilli neri per giglio
Stamen lily tip-black



COD. 40-W118

Pistilli bianchi punta lunga
Stamen long point dull-white



COD. 40-W120

Pistilli piccoli perlati rosa
Stamen small pearl pink



COD. 40-W121

Pistilli piccoli perlati gialli
Stamen small pearl yellow



COD. 40-W122

Pistilli neri piccoli
Stamen small dull-black



COD. 40-W123

Pistilli bianchi medi
Stamen medium dull-white

CONTROSTAMPI - FLOWER FORMERS



COD. EFT13 30x40mm

COD. EFT07 60x40mm

Larghezza - width 19mm
Altezza - high 14mm

Per gli stampi
For the moulds:

Cod. 40-0015 serrated leaves
Cod. 40-0016 smooth leaves
Cod. 40-1314 butterfly



COD. EFT12 30x40mm

COD. EFT05 60x40mm

Misura alveolo Alveolus size
Ø30mm h 20mm

Per gli stampi
For the moulds:

Cod. 40-0910 flower
Cod. 40-W028 small rose



COD. EFT10 30x40mm

COD. EFT02 60x40mm

Misura alveolo Alveolus size
Ø50mm h 25mm

Per gli stampi
For the moulds:

Cod. 40-0102 big gerbera
Cod. 40-0304 big sunflower
Cod. 40-0506 big daisy
Cod. 40-0708 big six petals flower
Cod. 40-W008 small carnation
Cod. 40-W028 big rose
Cod. 40-W003 athurium
Cod. 40-W005 cosmos
Cod. 40-W007 small peony
Cod. 40-W207S big peony



COD. EFT11 30x40mm

COD. EFT04 60x40mm

Misura alveolo Alveolus size
Ø40mm h 20mm

Per gli stampi
For the moulds:

Cod. 40-0102 small gerbera
Cod. 40-0304 small sunflowers
Cod. 40-0506 small daisy
Cod. 40-0708 small six petals flower
Cod. 40-W008 small carnation
Cod. 40-W028 medium rose

TULIPANO - TULIP



COD. 40-W194C

380x280mm
5 teglie per: / 5 Flowers formers for:
Tulip plunger cutter
cod. 40-W194S

COD. 40-W194C1

380x280mm
1 teglia per: / 1 Flowers former for:
Tulip plunger cutter
cod. 40-W194S

DALIA - DAHLIA



COD. 40-W206C

380x280mm
5 teglie per: / 5 Flowers formers for:
Dahlia plunger cutter
cod. 40-W206S

COD. 40-W206C1

380x280mm
1 teglia per: / 1 Flowers former for:
Dahlia plunger cutter
cod. 40-W206S

IBISCUS



COD. 40-W027

Ø 115 h55mm
Kit 4 pcs:
Ibiscus cod. 40-W051S

CYMBIDIUM



COD. 40-W054

Ø 150 h55mm
Kit 4 pcs:
Cymbidium Orchid cod. 40-W045

LILY



COD. 40-W055

Ø 160 h60mm
Kit 4 pcs:
Lily cod. 40-W002 / 40-W049S

CHINESE - 3 PETALS - PANSY



COD. 40-W053

Ø 132 h55mm
Kit 4 pcs:
Chinese Orchid cod. 40-W009 / 40-W044
Three petals Orchid cod. 40-W006
Pansy Orchid cod. 40-W030

POINSETTIA



COD. 40-W189

Ø 126 h35mm
Kit 4 pcs:
Stella di Natale
Poinsettia plunger cutter cod. 40-W188S

SURFINIA



COD. 40-W193C

Ø 75 h50mm
Kit 4 pcs:
Surfinia plunger cutter cod. 40-W193S

DAISY - EDELWEISS



COD. 40-W192C

Ø 55 h30mm
Kit 4 pcs:
Daisy plunger cutter cod. 40-W192S
Stella Alpina - Edelweiss cutter cod. 40-W205S

CALLA - PETUNIE



COD. 40-W082

Kit 10 controstampi per:
10 Flowers formers for:
Petunie cutter cod. 40-W029
Calla cutter cod. 40-1112

TULIP



COD. 40-W194B

Ø120 h100 mm
5 basette per:
5 Flowers formers for:
Tulip plunger cutter cod. 40-W194S

SNOWDROP



COD. 40-W204C

Kit 4 controstampi cono
e 1 teglia 160x80mm per Bucaneve.
4 Flowers cones formers
1 tray 160x80mm for Snowdrop.

STANTUFFI PER DECORAZIONI DECORATION PLUNGER CUTTERS



Trattore - Tractor

COD. 40-W201S

Set 4 pcs stampo stantuffo - plunger cutter
58x85mm - 36x73mm
ruote/ wheels Ø32mm - Ø24mm



Treno - Train

COD. 40-W202S

Set 4 pcs stampo stantuffo - plunger cutter
58x62mm - 48x65mm - 35x55mm
ruota/ wheel Ø19mm



Soggetti Marini Marine Subjects

COD. 40-W211S

Set 4 pcs stampo stantuffo - plunger cutter
62x62mm - 48x59mm - 57x32mm - 23x26mm



Strumenti musicali Musical instruments

COD. 40-W203S

Set 4 pcs stampo stantuffo - plunger cutter
107x42mm - 67x34mm - 74x43mm -
42x19mm



Orsetti - Teddy Bears

COD. 40-W156S

Set 3 pcs stampo stantuffo - plunger cutter
19x21mm 31x34mm - 43x47mm

Pinguini - Penguins

COD. 40-W155S

Set 3 pcs stampo stantuffo - plunger cutter
20x29mm - 34,5x34mm - 54x32mm



Fiocchi di neve Snowflakes

COD. 40-W010S

Set 3 pcs stampo stantuffo - plunger cutter
Ø25mm - Ø40mm - Ø56mm



Cuoricini - Small hearts

COD. 40-W013S

Set 3 pcs stampo stantuffo - plunger cutter
6x7mm - 8x10mm - 13x14mm

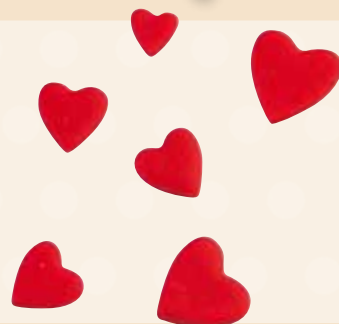

Stelline - Stars

COD. 40-W018S

Set 3 pcs stampo stantuffo - plunger cutter
Ø6,5mm - Ø11mm - Ø12,5mm



Renne - Reindeers

COD. 40-W157S

Set 3 pcs stampo stantuffo - plunger cutter
24x23mm - 39x29mm - 53x37mm



Agrifoglio - Holly

COD. 40-W043S

Set 3 pcs stampo stantuffo - plunger cutter
22x20mm - 30x28mm - 45x40mm

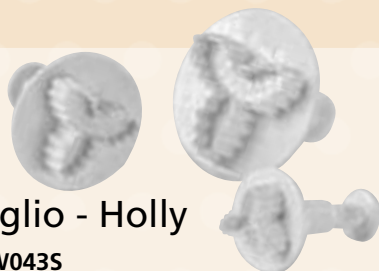

Agrifoglio - Holly

COD. 40-W091S

Set 3 pcs stampo stantuffo - plunger cutter
10x20mm - 16x28mm - 20x35mm





Fiori cinque petali Five petals flowers

COD. 40-W015S

Set 4 pcs stampo stantuffo - plunger cutter
Ø6 - Ø9 - Ø14 - Ø24mm



Fiori cinque petali Five petals flowers

COD. COD. 40-W162S

Set 4 pcs stampo stantuffo - plunger cutter
Ø15 - Ø18 - Ø25 - Ø30mm



Margherite - Daisies

COD. 40-W014S

Set 4 pcs stampo stantuffo - plunger cutter
Ø12 - Ø20 - Ø28 - Ø35mm



Fiori sei petali Six petals flowers

COD. 40-W161S

Set 4 pcs stampo stantuffo - plunger cutter
Ø13 - Ø18 - Ø24 - Ø32mm

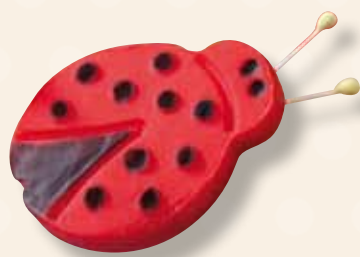

Coccinelle - Ladybugs

COD. 40-W160S

Set 3 pcs stampo stantuffo - plunger cutter
19x14mm - 28x21mm - 35x27mm



Fiocco - Bow

COD. 40-W158S

Set 3 pcs stampo stantuffo - plunger cutter
20x22mm - 32x35mm - 43x47mm



Palme e Sole Palms and Sun

COD. 40-W163S

Set 3 pcs stampo stantuffo - plunger cutter
23x23mm - 32x32mm - 50x43mm

Api - Bees

COD. 40-W159S

Set 3 pcs stampo stantuffo - plunger cutter
20x21mm - 31x34mm - 43x47mm



Coniglio Cestino e Carota Rabbit Basket and Carrot

COD. 40-W195S

Set 3 pcs stampo stantuffo - plunger cutter
38x46 - 33x37 - 26x14 mm



Colombe - Doves

COD. 40-W196S

Set 2 pcs stampo stantuffo - plunger cutter
47x47 - 45x43 mm



Campane e Colomba Bells and Dove

COD. 40-W197S

Set 2 pcs stampo stantuffo - plunger cutter
62x53 - 57x36 mm

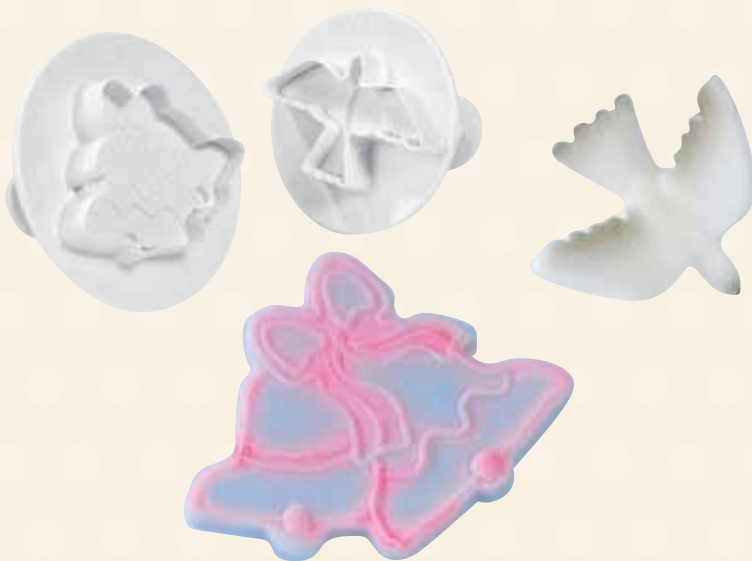



Ortensia - Hydrangea

COD. 40-W050S

Set 4 pcs stampo stantuffo - plunger cutter
25x20mm - 34x28mm - 45x37mm - 54x45mm

Comporre i fiori usando teglie alveolari: EFT05-EFT12
Use the alveolar trays to create flower: EFT05-EFT12



Foglie Rose - Rose Leaves

COD. 40-W016S

Set 3 pcs stampo stantuffo - plunger cutter
17x27mm - 20x33mm - 25x40mm



Foglie Edera - Ivy Leaves

COD. 40-W017S

Set 3 pcs stampo stantuffo - plunger cutter
20x20mm - 30x27mm - 37x37mm



Decoro due Fregi Two Friezes decorations

COD. 40-W140

Set 2 pcs stampo stantuffo decori intercambiabili
Set 2 pcs plunger cutter interchangeable decoration
73x43mm



Decoro due Fregi Two Friezes decorations

COD. 40-W011S

Set 2 pcs stampo stantuffo decori intercambiabili
Set 2 pcs plunger cutter interchangeable decoration
73x43mm

DIME PER MASCHERE DI CARNEVALE CARNIVAL MASK TEMPLATES

Dime per realizzare maschere in pasta zucchero.
Templates to create masks with sugar paste.



Dime maschere Masks Templates

COD. 40-W300

Kit 6 dime per realizzare maschere in pasta zucchero,
stencil aerografia fantasia arlecchino.
Six templates kit to realize sugarpaste masks
Harlequin stencil



COD. 40-W300C1
Controstampo maschere
Masks Former
1 pc



COD. 40-W300C
Controstampi maschere
Masks Formers
Set 4 pcs

STAMPI PER BISCOTTONI COOKIE MOULDS

DECORALI CON LA PASTA ZUCCHERO
DECORATED WITH SUGARPASTE



Dinosauri Dinosaurs

40-WB102

Taglia biscotto 2 pz
Cookie cutters 2 pcs
76x69mm - 95x69mm





Pirati Pirates

COD. 40-WB101

Taglia biscotto 2 pz
Cookie cutters 2 pcs
78x74mm - 70x77mm



Carrozza e Principessa Carriage and Princess

COD. 40-WB106

Taglia biscotto 2 pz
Cookie cutters 2 pcs
Ø84mm - 67x96mm



Scarpone e Palla Boot and Ball

COD. 40-WB103

Taglia biscotto 2 pz
Cookie cutters 2 pcs
Ø87mm - 82x64mm



Angelo e Diavolo Angel and Devil

COD. 40-WB104

Taglia biscotto 2 pz
Cookie cutters 2 pcs
83x63mm - 64x76mm



Bimbo Bimba Little Boy Little Girl

COD. 40-WB105

Taglia biscotto 2 pz
Cookie cutters 2 pcs
60x92mm - 60x92mm



Zucca e Pipistrello Pumkin and Bat

COD. 40-WB100

Taglia biscotto 2 pz
Cookie cutters 2 pcs
85x94mm - 85x79mm





Stencil for airbrush included

Pulcinella e Arlecchino Pulcinella and Harlequin

COD. 40-WB109

Taglia biscotto 2 pz / Cookie cutters 2 pcs
85x66mm - 92x71mm
Stencil per aerografie dettagli 2 pz
Airbrush stencils for details 2 pcs



Gallina e Coniglio Hen and Rabbit

COD. 40-WB107

Taglia biscotto 2 pz / Cookie cutters 2 pcs
90x75mm - 90x77mm
Stencil per aerografie dettagli 2 pz
Airbrush stencils for details 2 pcs



Coniglietti innamorati Bunnies in love

COD. 40-WB108

Taglia biscotto 2 pz / Cookie cutters 2 pcs
88x68mm - 84x66mm
Stencil per aerografie dettagli 2 pz
Airbrush stencils for details 2 pcs



PASTE E TAPPETI DECORO MIXTURES AND MATS



Tappeti in silicone.

Ideali per vestire il tuo dolce con un decoro in zucchero di grande effetto.
Misure disponibili: Tappeto 30x40cm - Tappeto 10x40cm - Tappeto 6x40cm

Silicone mats.

Ideal to dress up your cake with an impressive sugar decoration.
Available sizes: Mat 30x40cm - Mat 10x40cm - Mat 6x40cm



Misura Decoro - Decorations size 374x80mm

COD. 40-WD013 Tappeto - Mat 30x40cm - 3 decori

COD. 40-WD013T Tappeto - Mat 10x40cm - 1 decoro



Misura Decoro - Decorations size 380x73mm

COD. 40-WD015 Tappeto - Mat 30x40cm - 3 decori

COD. 40-WD015T Tappeto - Mat 10x40cm - 1 decoro

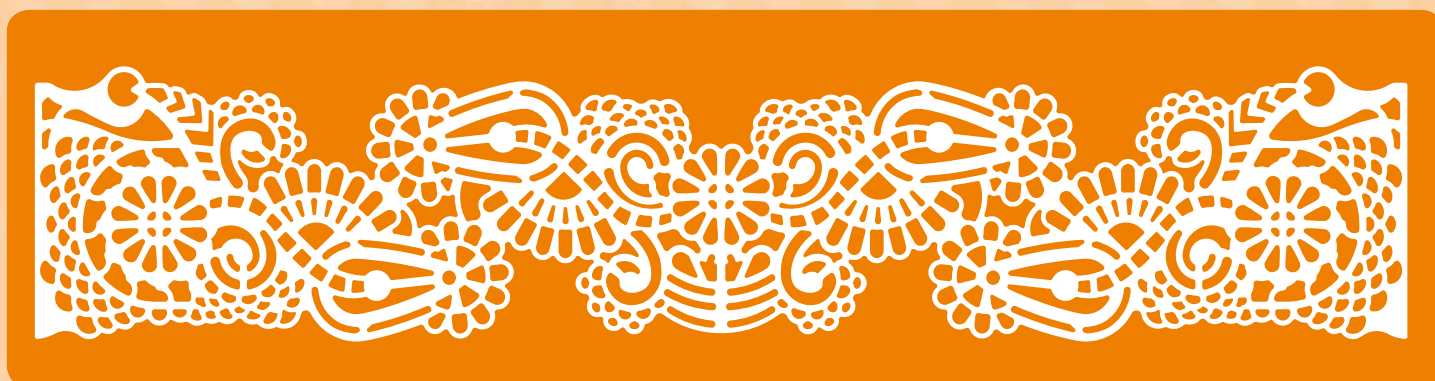

Misura Decoro - Decorations size 380x76mm

COD. 40-WD016 Tappeto - Mat 30x40cm - 3 decori

COD. 40-WD016T Tappeto - Mat 10x40cm - 1 decoro



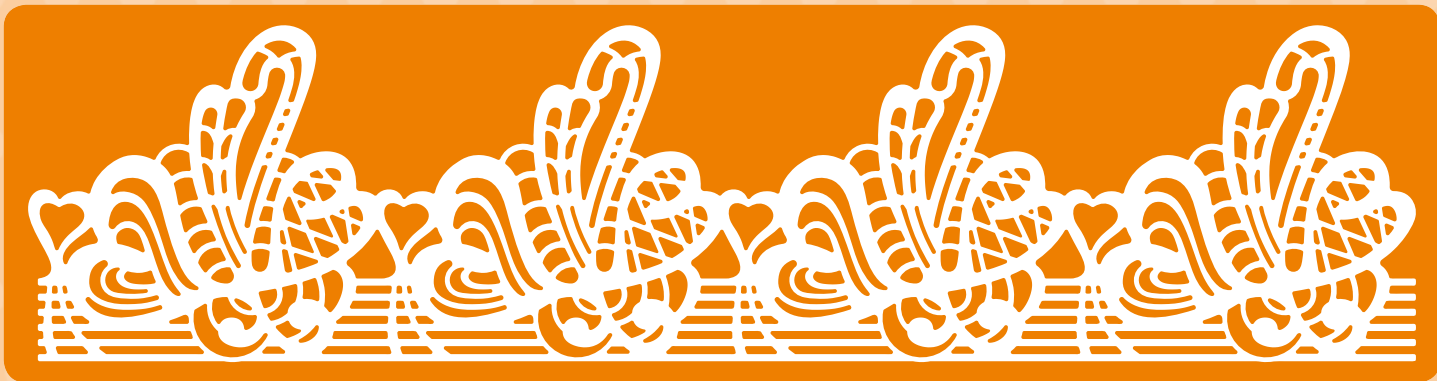

Misura Decoro - Decorations size 356x87mm

COD. 40-WD009 Tappeto - Mat 30x40cm - 3 decori

COD. 40-WD009T Tappeto - Mat 10x40cm - 1 decoro

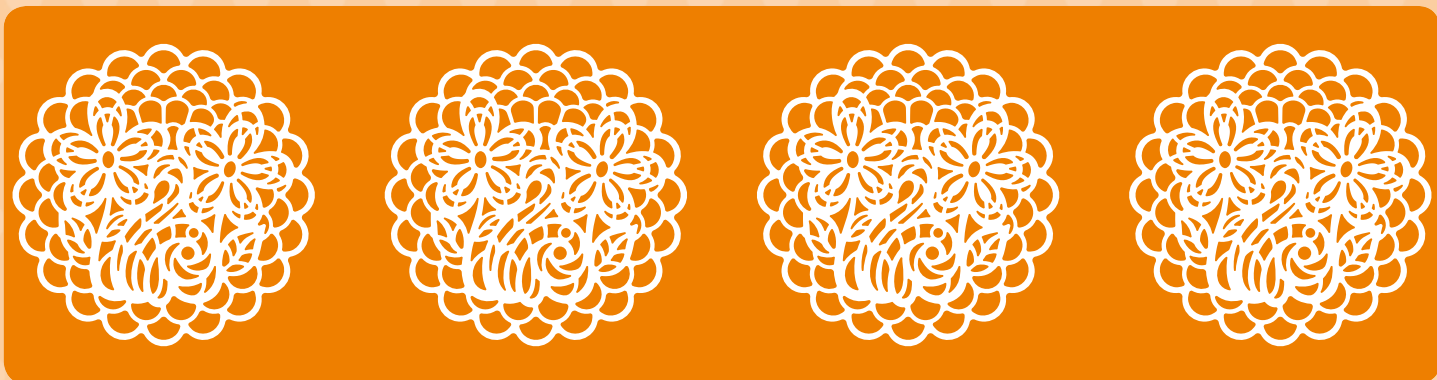

Misura Decoro - Decorations size Ø88mm

COD. 40-WD002 Tappeto - Mat 30x40cm - 12 decori

COD. 40-WD002T Tappeto - Mat 10x40cm - 4 decori



Misura Decoro - Decorations size 388x88mm

COD. 40-WD001 Tappeto - Mat 30x40cm - 3 decori

COD. 40-WD001T Tappeto - Mat 10x40cm - 1 decoro

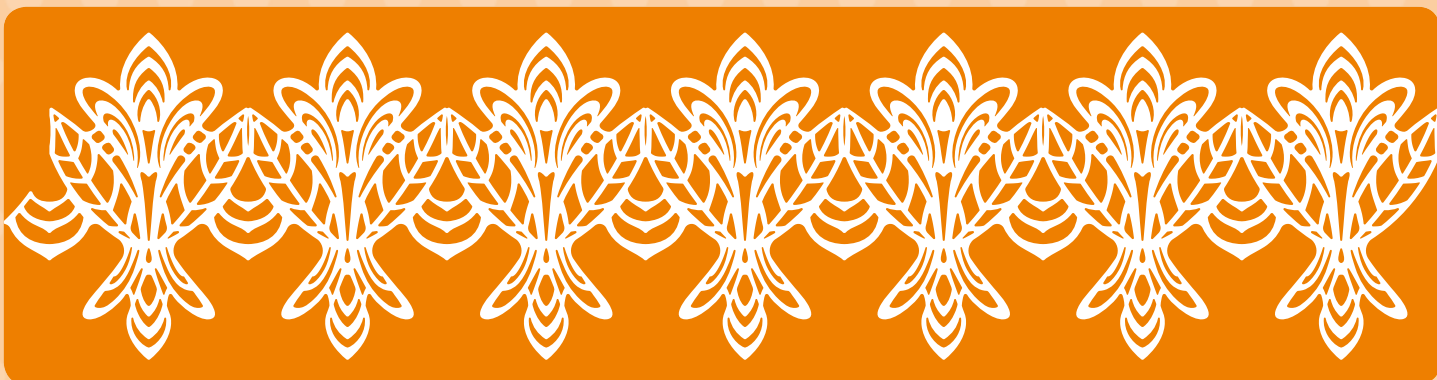

Misura Decoro - Decorations size 380x86mm

COD. 40-WD005 Tappeto - Mat 30x40cm - 3 decori

COD. 40-WD005T Tappeto - Mat 10x40cm - 1 decoro

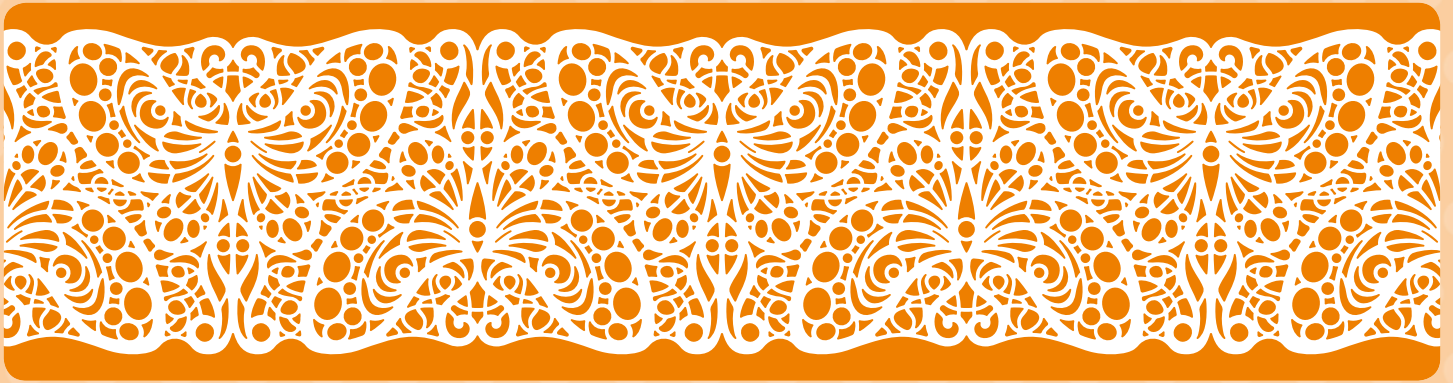

Misura Decoro - Decorations size 388x86mm

COD. 40-WD003 Tappeto - Mat 30x40cm - 3 decori

COD. 40-WD003T Tappeto - Mat 10x40cm - 1 decoro

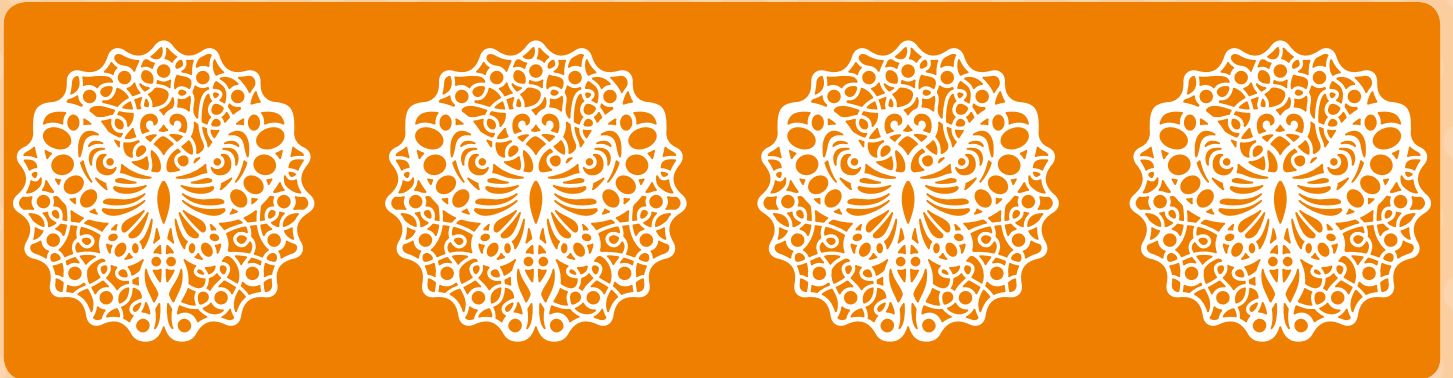

Misura Decoro - Decorations size Ø79mm

COD. 40-WD004 Tappeto - Mat 30x40cm - 12 decori

COD. 40-WD004T Tappeto - Mat 10x40cm - 4 decori



Misura Decoro - Decorations size 72x72mm

COD. 40-WD006 Tappeto - Mat 30x40cm - 10 decori

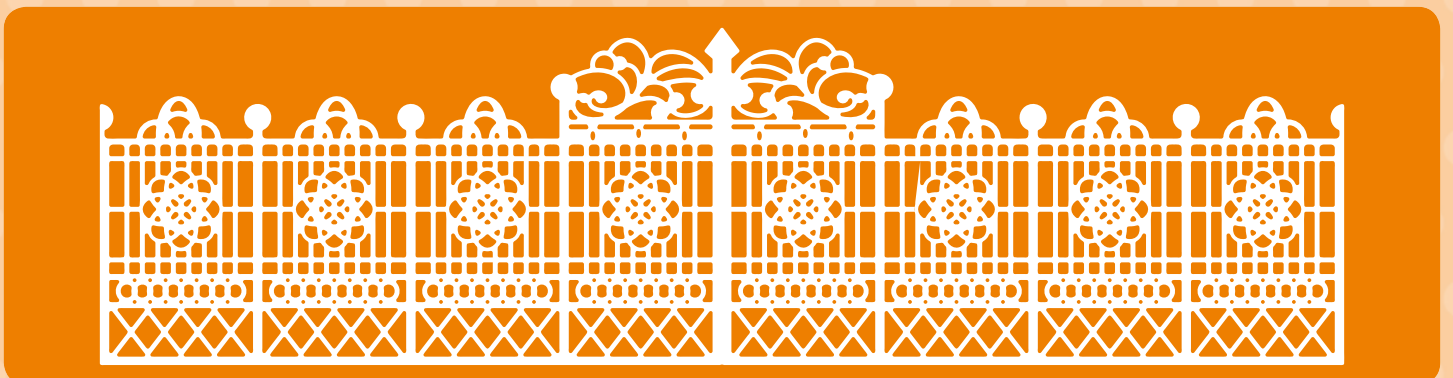

Misura Decoro - Decorations size 330x89mm

COD. 40-WD007 Tappeto - Mat 30x40cm - 3 decori

COD. 40-WD007T Tappeto - Mat 10x40cm - 1 decoro

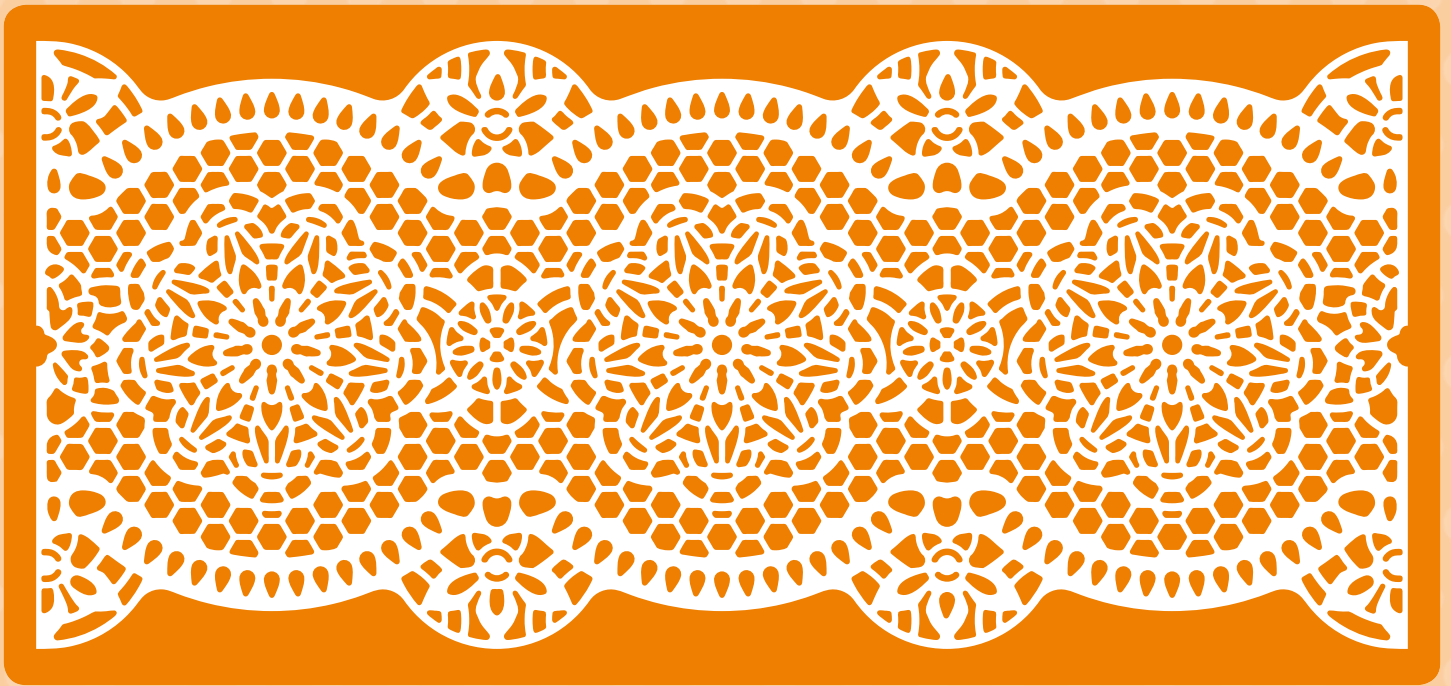

Misura Decoro - Decorations size 260x114mm

COD. 40SQ001 Tappeto - Mat 30x40cm - 3 decori

COD. 40SQ001T Tappeto - Mat 30x13cm - 1 decoro



Misura Decoro - Decorations size 356x87mm

COD. 40-WD008 Tappeto - Mat 30x40cm - 3 decori

COD. 40-WD008T Tappeto - Mat 10x40cm - 1 decoro

Sugar Dress e Sugar Pearl è un prodotto che garantisce un risultato finale sufficientemente elastico e resistente per evitare rotture in fase di sfornatura o posizionamento sul dolce. È sufficiente aggiungere ai due preparati dell'acqua, mescolare bene il composto e spalmarlo con una spatola nell'apposito tappetino Martellato. **Un sistema facile e veloce per ottenere un decoro raffinato e di grande effetto.**

Sugar Dress and Sugar Pearl is a product that provides a final result sufficiently elastic and resistant to avoid breakage during the demoulding or positioning in the cake.

It's enough just to add some water to the two preparations, mix well and spread the mixture with a spatula into the Martellato mat.

An easy and fast way to get a refined and impressive decoration.



Tutti i colori a pg 67 - All colors pg 67



Misura Decoro - Decorations size 90x60mm

COD. 40-WD017 Tappeto - Mat 30x40cm - 16 decori

COD. 40-WD017T Tappeto - Mat 7,5x40cm - 4 decoro

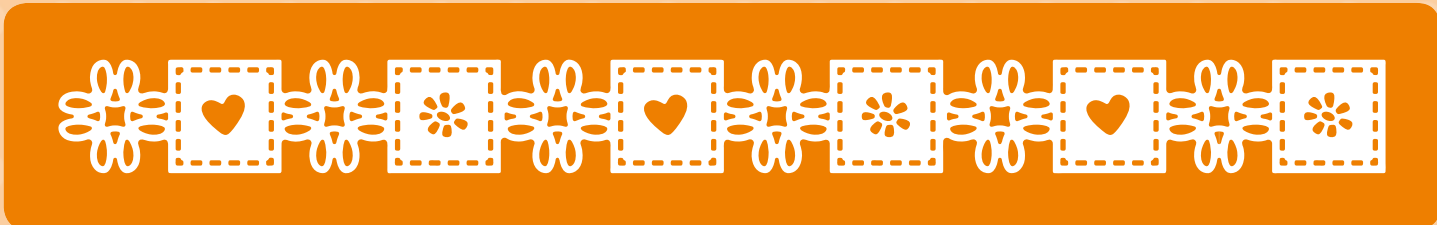

Misura Decoro - Decorations size 351x30mm

COD. 40-WD014 Tappeto - Mat 30x40cm - 5 decori

COD. 40-WD014T Tappeto - Mat 6x40cm - 1 decoro



Misura Decoro - Decorations size 372x49mm

COD. 40-WD010 Tappeto - Mat 30x40cm - 5 decori

COD. 40-WD010T Tappeto - Mat 6x40cm - 1 decori



Misura Decoro - Decorations size 386x45mm

COD. 40-WD011 Tappeto - Mat 30x40cm - 5 decori

COD. 40-WD011T Tappeto - Mat 6x40cm - 1 decori



Misura Decoro - Decorations size 350x46mm

COD. 40-WD012 Tappeto - Mat 30x40cm - 5 decori

COD. 40-WD012T Tappeto - Mat 6x40cm - 1 decori

STENCIL PER GHIACCIA ICING STENCILS

Pensati per la ghiaccia, ma utilissimi anche a chi piace aerografare. Ideali per dare quel tocco in più alle torte più particolari, o come unico decoro per chi ama le cose semplici e belle!

Designed for the icing, but also useful for those who like airbrushing. Ideal to give that extra touch the cakes, or as a unique decoration for those who love simple and beautiful things!



STENCIL PICCOLI DECORI SMALL DECORATION STENCILS

Misura Stencil - Stencil Size: 340x90mm

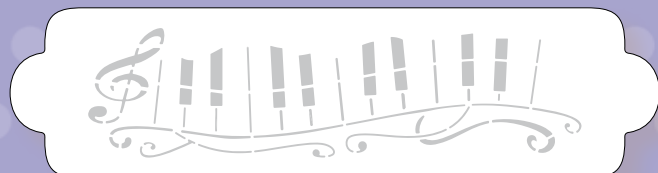

COD. 40-WSR015
Misura Decoro - Decorations size: 261x68mm

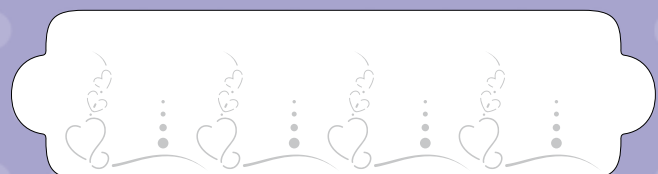

COD. 40-W168
Misura Decoro - Decorations size: 286x64mm

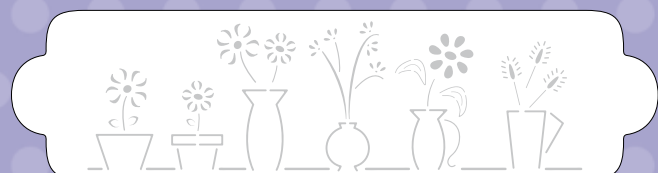

COD. 40-W170
Misura Decoro - Decorations size: 263x80mm



COD. 40-W172
Misura Decoro - Decorations size: 282x68mm

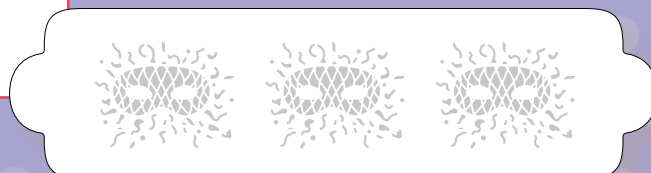

COD. 40-WSR016
Misura Decoro - Decorations size: 254x56mm



COD. 40-WSR001
Misura Decoro - Decorations size: 240x65mm

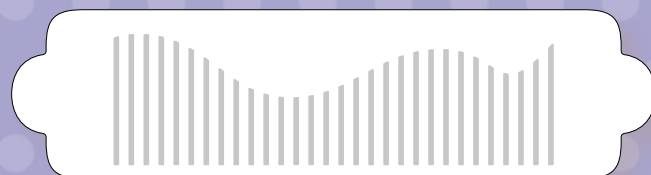

COD. 40-WSR003
Misura Decoro - Decorations size: 235x70mm

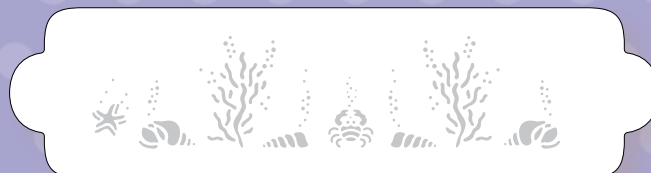

COD. 40-WSR018
Misura Decoro - Decorations size: 247x60mm



COD. 40-WSR019
Misura Decoro - Decorations size: 260x56mm



COD. 40-W169
Misura Decoro - Decorations size: 234x74mm



COD. 40-W171
Misura Decoro - Decorations size: 287x65mm



COD. 40-W173
Misura Decoro - Decorations size: 293x64mm

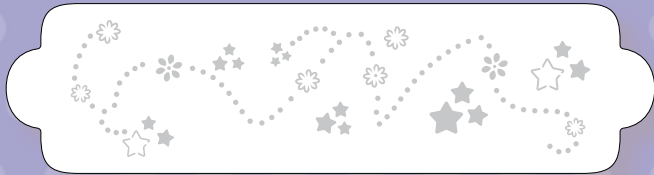

COD. 40-WSR005

Misura Decoro - Decorations size: 275x73mm



COD. 40-WSR017

Misura Decoro - Decorations size: 247x58mm

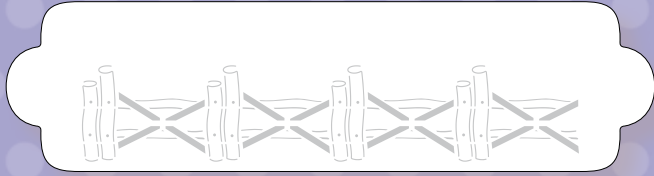

COD. 40-WSR007

Misura Decoro - Decorations size: 263x51mm



COD. 40-WSR002

Misura Decoro - Decorations size: 285x65mm

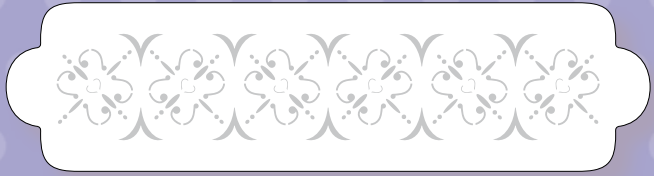

COD. 40-WSR009

Misura Decoro - Decorations size: 290x57mm



COD. 40-WSR004

Misura Decoro - Decorations size: 270x62mm



COD. 40-WSR011

Misura Decoro - Decorations size: 278x68mm



COD. 40-WSR006

Misura Decoro - Decorations size: 278x50mm



COD. 40-WSR013

Misura Decoro - Decorations size: 280x50mm



COD. 40-WSR008

Misura Decoro - Decorations size: 263x43mm

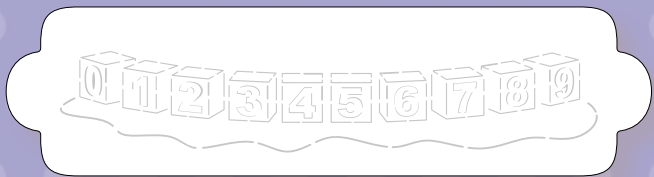

COD. 40-WSR010

Misura Decoro - Decorations size: 286x54mm

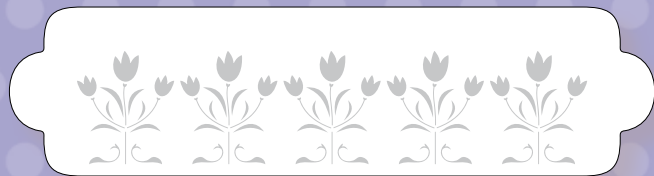

COD. 40-WSR012

Misura Decoro - Decorations size: 271x60mm



COD. 40-WSR014

Misura Decoro - Decorations size: 257x72mm



STENCIL GRANDI DECORI
LARGE DECORATION STENCILS

Misura Stencil - Stencil Size: 347x127mm



COD. 40-W092

Misura Decoro - Decorations size: 250x85mm



COD. 40-W093

Misura Decoro - Decorations size: 206x88mm



COD. 40-W094

Misura Decoro - Decorations size: 226x80mm



COD. 40-W095

Misura Decoro - Decorations size: 200x85mm



COD. 40-W096

Misura Decoro - Decorations size: 225x82mm



COD. 40-W097

Misura Decoro - Decorations size: 250x88mm



COD. 40-W098

Misura Decoro - Decorations size: 268x90mm

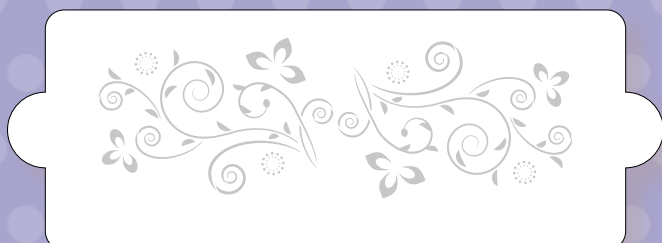

COD. 40-W099

Misura Decoro - Decorations size: 250x85



COD. 40-W100

Misura Decoro - Decorations size: 246x87mm





COD. 40-W182 Ø100mm
COD. 40-W174 Ø200mm

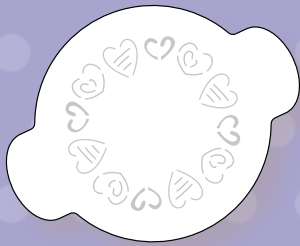

COD. 40-W181 Ø100mm
COD. 40-W175 Ø200mm



COD. 40-W183 Ø100mm
COD. 40-W176 Ø200mm



COD. 40-W184 Ø100mm
COD. 40-W177 Ø200mm



COD. 40-W186 Ø100mm
COD. 40-W178 Ø200mm



COD. 40-W187 Ø100mm
COD. 40-W179 Ø200mm



COD. 40-W185 Ø100mm
COD. 40-W180 Ø200mm

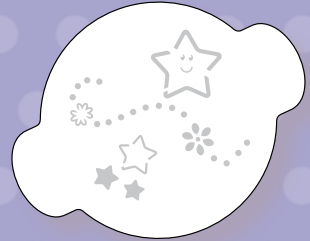

COD. 40-WST001 Ø100mm
COD. 40-WST501 Ø200mm



COD. 40-WST002 Ø100mm
COD. 40-WST502 Ø200mm



COD. 40-WST003 Ø100mm
COD. 40-WST503 Ø200mm



COD. 40-WST004 Ø100mm
COD. 40-WST504 Ø200mm



COD. 40-WST005 Ø100mm
COD. 40-WST505 Ø200mm



COD. 40-WST006 Ø100mm
COD. 40-WST506 Ø200mm



COD. 40-WST007 Ø100mm
COD. 40-WST507 Ø200mm



COD. 40-WST008 Ø100mm
COD. 40-WST508 Ø200mm



COD. 40-WST009 Ø100mm
COD. 40-WST509 Ø200mm

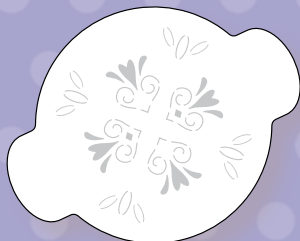

COD. 40-WST010 Ø100mm
COD. 40-WST510 Ø200mm



COD. 40-WST011 Ø100mm
COD. 40-WST511 Ø200mm



COD. 40-WST012 Ø100mm
COD. 40-WST512 Ø200mm



COD. 40-WST013 Ø100mm
COD. 40-WST513 Ø200mm



COD. 40-WST014 Ø100mm
COD. 40-WST514 Ø200mm



STENCIL AEROGRAFIA AIRBRUSH STENCILS

Martellato promuove un inedito sistema per personalizzare le torte utilizzando degli eccezionali stencil che permettono infinite possibilità di decorazione. Gli stencil sono facilmente utilizzabili anche da chi non dispone di buone conoscenze sull'uso dell'aerografo.

Martellato introduces a new system of stencils to decorate your cake in multiple ways. Our stencils can be used even by beginners.



COD. 40-WM506

Stencil Fiore di Loto Grande
Big Lotus Flower Stencil - KIT 2 STENCIL
132x152mm - 10 STEPS



COD. 40-WM042

Stencil Fiore di Loto Piccolo
Small Lotus Flower Stencil
106x101mm - 6 STEPS



COD. 40-WM033

Stencil ramoscello mimosa
Mimosa stencil
100x99mm - 3 STEPS



COD. 40-WM026

Stencil orchidea
Orchid stencil
90x132mm - 4 STEPS

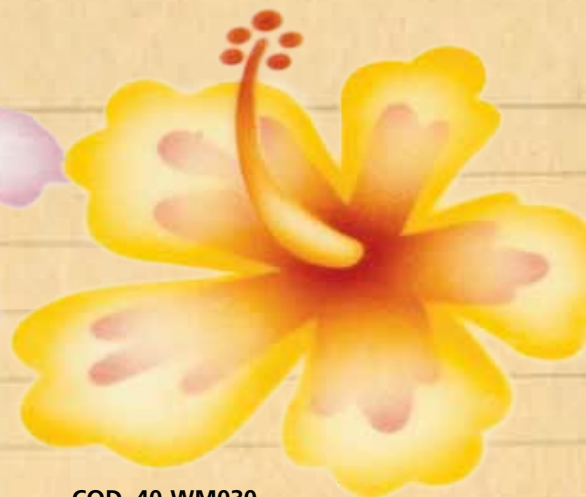

COD. 40-WM030

Stencil ibiscus - 2 misure
Ibiscus stencil - 2 sizes
92x100mm - 58x62mm - 3 STEPS



COD. 40-WM027

Stencil rosa aperta
Open rose stencil
93x150mm - 7 STEPS



COD. 40-WM029

Stencil bocciolo rosa
Rose blossom stencil
51x107mm - 6 STEPS



COD. 40-WM028

Stencil bocciolo rosa
Rose blossom stencil
64x140mm - 6 STEPS

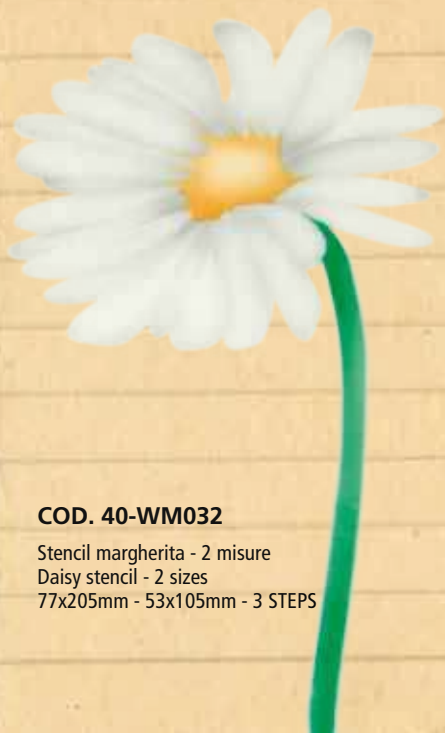

COD. 40-WM032

Stencil margherita - 2 misure
Daisy stencil - 2 sizes
77x205mm - 53x105mm - 3 STEPS



COD. 40-WM031

Stencil giglio tigrato
Lily tiger stencil
98x102mm - 5 STEPS

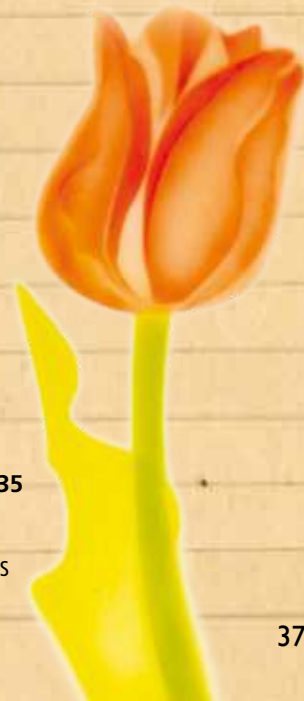

COD. 40-WM035

Stencil tulipano
Tulip stencil
170x63mm - 7 STEPS



COD. 40-WM507

Teschio Laterale
Lateral Skull - KIT 2 STENCIL
107x113mm - 11 STEPS



COD. 40-WM043

Teschio Frontale
Frontal Skull
93x100mm - 12 STEPS



COD. 40-WM044

Stencil aerografia palline di Natale
Christmas decorations airbrush stencil
69x120mm - 50x80mm - 4 steps



COD. 40-WM045

Stencil aerografia zebrato
Zebline airbrush stencil
230x230mm - 1 step



COD. 40-WM025

Stencil sole e nuvole - elementi misti
Sun and clouds stencil - various subj.



COD. 40-WM015

Stencil orsetto cuore
Little bear with heart
102X143mm - 4 STEPS



COD. 40-WM016

Stencil coniglietto
Boy bunny stencil
77X132mm - 4 STEPS



COD. 40-WM017

Stencil coniglietta
Girl bunny stencil
78X133mm - 4 STEPS



COD. 40-WM010

Stencil ramo fiori di pesco e 2 fiori
Peach blossom stencil and 2 flowers
50x82mm - 40x40mm - 21x25mm



COD. 40-WM001

Stencil ape con cuore
Bee with heart stencil
130X133mm - 4 STEPS



COD. 40-WM508

Palloni da Calcio
Football balls - KIT 2 STENCIL
Ø65mm - Ø88mm- 5 STEPS



COD. 40-WM047

Stencil aerografia fiori
Flowers airbrush stencil
110x130mm - 3 STEPS



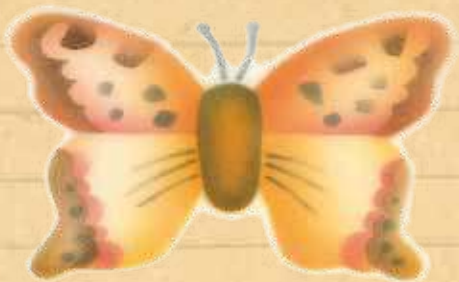

COD. 40-WM034

Stencil farfalla piccola rif cutter 40-1314
Small butterfly stencil ref cutter 40-1314
51x40mm - 5 STEPS



COD. 40-WM004

Stencil gallo gallina - Rooster / hen stencil
192x103mm - 2 STEPS



COD. 40-WM007

Stencil farfalle - 2 misure
Butterflies stencil - 2 sizes
92x78mm - 50x43mm - 4 STEPS



COD. 40-WM003

Stencil coniglietto
Bunny stencil
78x112mm - 4 STEPS



COD. 40-WM024

Stencil accessori rosa e pacco
Stencil rose and gift
60x52mm - 4 STEPS pacco - gift
44x100mm - 3 STEPS rosa - rose



COD. 40-WM006

Stencil sei uova pasquali
Six easter eggs stencil
misure miste - variuos sizes - 2 STEPS



COD. 40-WM005

Stencil pulcini - 2 misure
Chick stencil - 2 sizes
52x80mm - 36x56mm - 4 STEPS



COD. 40-WM009

Stencil campana
Bell stencil
92x84mm - 63x60mm - 3 STEPS



COD. 40-WM013

Stencil neonata
Baby girl stencil
93x119mm - 6 STEPS



COD. 40-WM014

Stencil neonato
Baby boy stencil
116x135mm - 4 STEPS



COD. 40-WM012

Stencil cicogna
Stork stencil
203x113mm - 3 STEPS



COD. 40-WM011

Stencil fedì nuziali - 2 misure
Wedding rings stencil - 2 sizes
172x58mm - 120x40 mm - 3 STEPS



COD. 40-WM008

Stencil cigni
Swans stencil
168x88mm - 2 STEPS

SUGGERIMENTI
SUGGESTIONS

Alcuni stencil si prestano per aerografie su biscottoni, ideali per impreziosire una sweet table o creare dei decori da appendere.

Some stencils are ideal to airbrush large cookies that can enrich your sweet tables or create hanging decorations.



COD. 40-WM040

Stencil Candele grandi e piccole
Big and small candles stencil
110x105 mm - 35x45 mm



COD. 40-WM041

Stencil Stella di Natale grande e piccola
Big and small Poinsettia stencil
70x70 mm - 37x37 mm

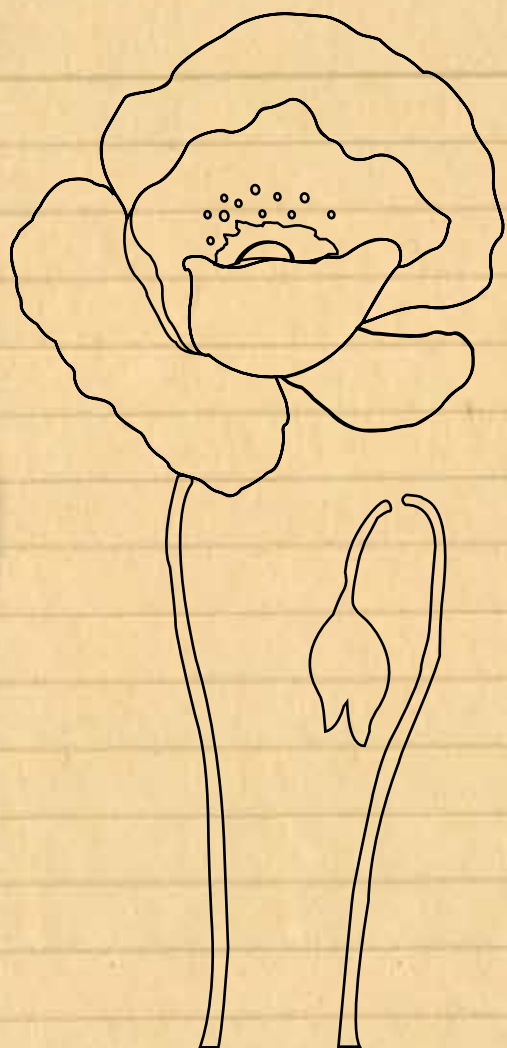

COD. 40-WM038

Stencil Papavero frontale grande e bocciolo
 Frontal big Poppy and bud stencil
 130x65 mm

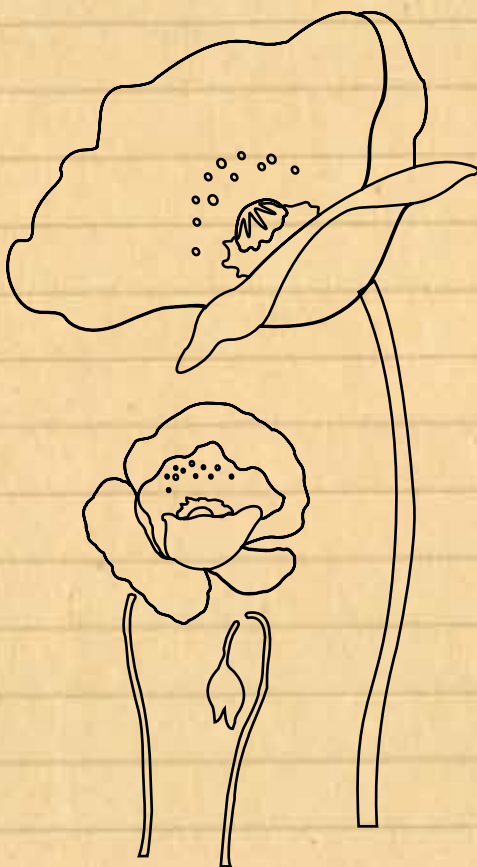

COD. 40-WM039

Stencil Papavero grande, piccolo e bocciolo
 Big, small and bud Poppy stencil
 110x62 mm - 60x30 mm

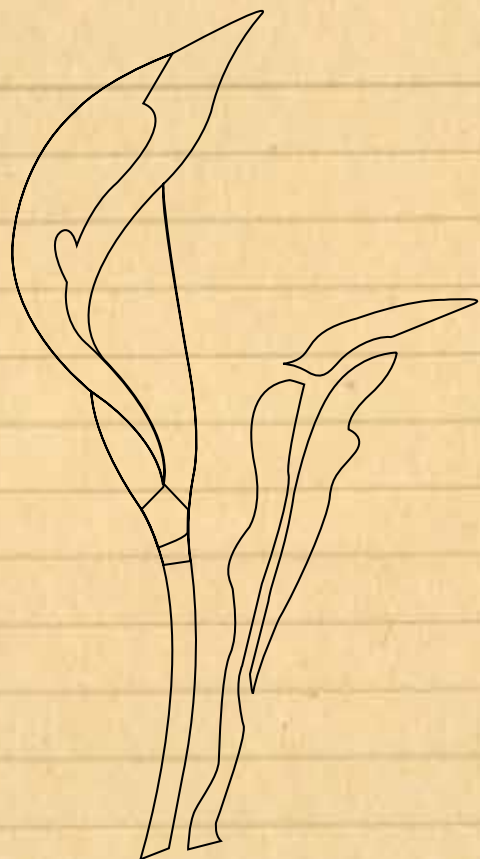

COD. 40-WM037

Stencil Calla laterale
 Lateral Calla stencil
 147x43 mm

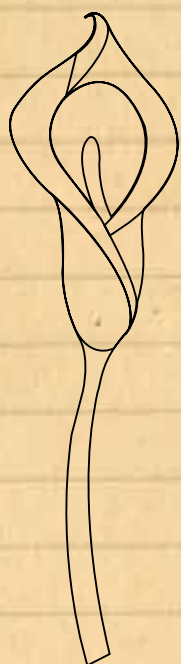

COD. 40-WM036

Stencil Calle grande e piccola frontali
 Frontal Callas stencil big and small
 170x44 mm - 95x25 mm





COD. 40-WM019

Stencil clown - clown stencil
95x91mm - 4 STEPS



COD. 40-WM020

Stencil clown - clown stencil
123X100mm - 4 STEPS



COD. 40-WM022

Stencil carnevale - elementi misti
Carnival stencil - various subjects
2 STEPS



COD. 40-WM021

Stencil maschera veneziana
Venetian mask stencil
108x95mm - 4 STEPS

COD. 40-WM048

Stencil gatto, luna e zucca
Cat, moon and pumpkin stencil
7 STEPS



COD. 40-WM002

Stencil strega con scopa
Witch with broom stencil
124X100mm - 4 STEPS



COD. 40-WM023

Stencil zucca
Pumpkin stencil
94x63mm - 4 STEPS



COD. 40-WM018

Stencil halloween - elementi misti
Halloween stencil - various subjects

KIT 2 STENCIL
2 STENCILS KIT



COD. 40-WM502

Stencil fidanzati - KIT 2 STENCIL
Lovers - KIT 2 STENCIL
140x115 mm - 5 STEPS



COD. 40-WM500

Stencil angeli e cuore - KIT 2 STENCIL
Angels and heart - KIT 2 STENCIL
150x104mm - 4 STEPS

COD. 40-WM501

Stencil colomba spighe e calice
KIT 2 STENCIL
Dove spike and cup
KIT 2 STENCIL
160x160mm - 50x85 calice



COD. 40-WM504

Stencil colomba e ulivo - KIT 2 STENCIL
Dove and olive-branch - KIT 2 STENCIL
160x115mm - 5 STEPS



COD. 40-WM505

Stencil girasole - KIT 2 STENCIL
Sunflower - KIT 2 STENCIL
105x165mm - 6 STEPS



COD. 40-WM503

Stencil natura - elementi misti - KIT 2 STENCIL
Stencil nature - various subjects - KIT 2 STENCIL

Stencil PIED DE POULE PIED DE POULE Stencil

COD. 40-WM046

1 stencil
230x230mm



Stencil I LOVE VINTAGE I LOVE VINTAGE Stencil

COD. 40-WM509

Kit 2 stencil



Stencil RIGHE LINES Stencil

COD. 40-WR001

Kit stencil righe per torte Ø20 Ø30 Ø40cm.
Il kit è composto da:
6 stencil rettangolari per aerografia verticale
2 stencil a spicchio per righe su superficie piana.

Kit stencil lines for cakes Ø20 Ø30 Ø40cm.
The kit consists of:
6 rectangular stencils for vertical airbrushing
2 slice shaped stencil for lines on a flat surface.



Stencil POIS POIS Stencil

COD. 40-WR005

Kit 2 stencil
230x230mm - 130x130mm

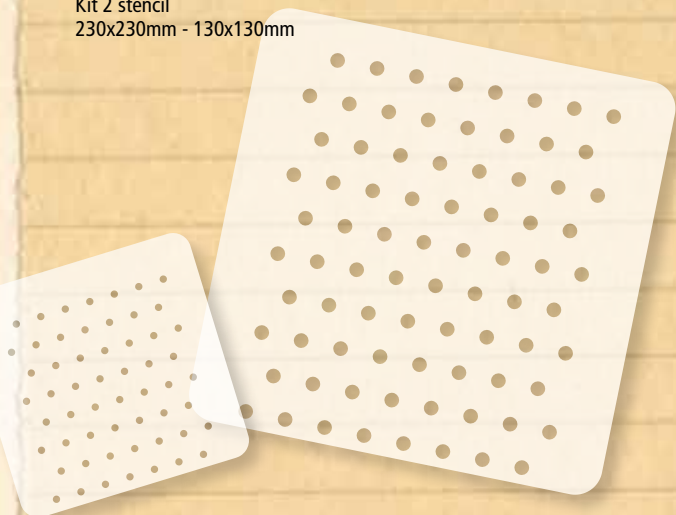

Stencil POIS POIS Stencil

COD. 40-WR002

Stencil singolo - Single Stencil
230x230mm



Stencil SCOZZESE TARTAN Stencil

COD. 40-WR003

Kit 2 stencil
230x230mm



Stencil VINTAGE VINTAGE Stencil

COD. 40-WR004

Kit 2 stencil
230x230mm

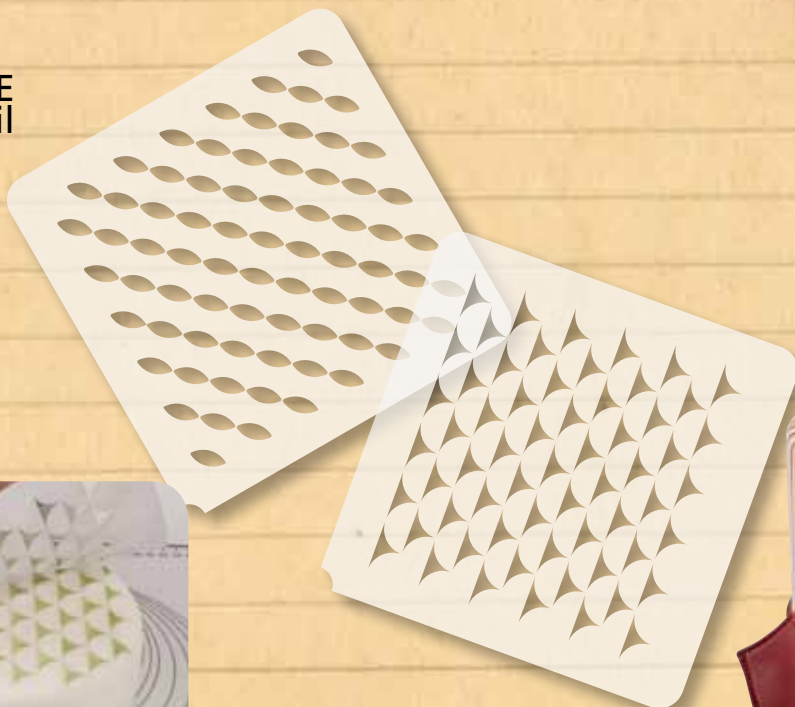

AEROGRAFI E ACCESSORI AIRBRUSH AND ACCESSORIES



Compressore - Airpump
COD. DECOMP7

Compressore - Air pump
4 bar



Compressore - Airpump
COD. DECOMP8

Compressore - Air pump
2,5 bar



Penna aerografa doppia azione
Airbrush double action

COD. DECOAIR2

Penna aerografa doppia azione - foro 0,3mm - Contenitore grande
Airbrush double action - nozzle 0,3mm - Big Cup

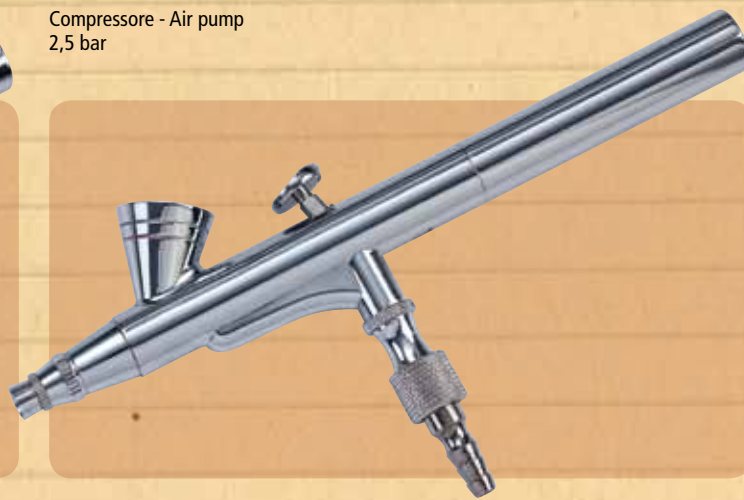

Penna aerografa doppia azione
Airbrush double action

COD. DECOAIR3

Penna aerografa doppia azione - foro 0,2mm - Contenitore piccolo
Airbrush double action - nozzle 0,2mm - Small Cup



Sostegno
Holder

COD. DECOH01

Sostegno per penne aerografe
Airbrushes holder



Filtro
Filter

COD. DECOF01

Filtro per penna aerografa
Airbrush filter

Cake Paint

COD. DECOCP01

Aerografo e Compressore Airbrush and Airpump

Il kit, ideale per piccole decorazioni, include:

- Penna aerografa a doppia azione, Ø 0,2mm;
- Mini Compressore da 1 BAR;
- Supporto per penna aerografa;
- Trousse nera da viaggio.

The kit is ideal for small decorations and includes:

- Airbrush double action, Ø 0.2mm;
- Mini compressor 1 BAR;
- Support for airbrush;
- Black travel bag.



Manuale Sweet Airbrush Sweet Airbrush Manual

COD. 40-W109

Manuale Sweet Airbrush - Sweet Airbrush manual
di Gian Paolo Panizzolo e Mario Romani
Italiano - English - Español

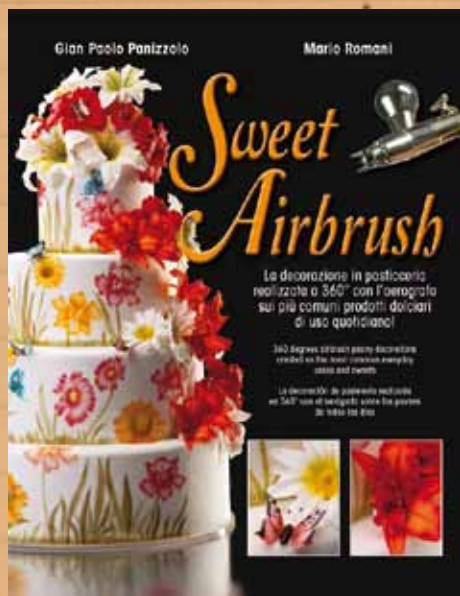

Frutto del lavoro di un Pasticcere e un Docente di Tecnica Aerografica, l'opera si presenta come primo e unico volume che tratti questa materia in modo dettagliato e completo, con grande risalto alle immagini e ai suggerimenti per i lettori.

Il manuale si divide in due parti: nella prima parte compare una stringata ma rappresentativa scelta di attrezzature, una sezione dedicata agli esercizi di base, e alcune tecniche per realizzare effetti molto frequenti, oltre a una pratica sezione sintetica dei problemi che si verificano, con i suggerimenti per la loro risoluzione.

Nella seconda parte si sviluppano step by step le applicazioni decorative in Pasticceria, relative a soggetti prescelti, riproducibili sulla stragrande maggioranza dei prodotti dolciari di uso quotidiano; step by step che forniscono le basi anche per la successiva realizzazione di creazioni proprie su pasta di zucchero, cioccolato, panna ecc.

The result of the work of a Pastry Chef and a master of Airbrush Technique, this is the first and only book that deals with this matter in a detailed and comprehensive way, with great emphasis to the images and suggestions for readers. The manual is divided in two parts: in the first part you can find a small but representative selection of equipment, a section devoted to the basic exercises and techniques to create frequent effects, as well as a section of concise practical problems that occur with suggestions for their solution.

In the second part you can see step by step decorative applications in Pastry, relating to subjects selected for reproduction on the vast majority of confectionery products of daily use, step by step that provide the foundation also for the subsequent realization of your own creations with sugar paste, chocolate, cream, etc..



TAPPETI DECORO IN RILIEVO RELIEF DECORATION MATS

È possibile imprimere la pasta con il tappeto utilizzando un mattarello o inserendo la pasta precedentemente stesa ed il tappeto all'interno della stendipasta Martellato.

It is possible to imprint the dough with a rolling pin or inserting the dough with the mat inside Martellato's machine.

Tappeto decorazione in rilievo motivo Legno
Relief decoration mat, Wood motif

COD. 40-W126 Misure - Sizes: 60x40cm
COD. 40-W131 Misure - Sizes: 40x20cm

Tappeto decorazione in rilievo motivo Mattone Regolare
Relief decoration mat, Regular Brick motif

COD. 40-W127 Misure - Sizes: 60x40cm
COD. 40-W132 Misure - Sizes: 40x20cm

Tappeto decorazione in rilievo motivo Mattone Irregolare
Relief decoration mat, Irregular brick motif

COD. 40-W128 Misure - Sizes: 60x40cm
COD. 40-W133 Misure - Sizes: 40x20cm

Tappeto decorazione in rilievo motivo Pietra
Relief decoration mat, Stone motif

COD. 40-W129 Misure - Sizes: 60x40cm
COD. 40-W134 Misure - Sizes: 40x20cm

Tappeto decorazione in rilievo motivo Tegola
Relief decoration mat, Tiles motif

COD. 40-W130 Misure - Sizes: 60x40cm
COD. 40-W135 Misure - Sizes: 40x20cm

Tappeto decorazione in rilievo motivo Farfalle
Relief decoration mat, Butterfly motif

COD. 40-W083 Misure - Sizes: 60x40cm
COD. 40-W150 Misure - Sizes: 40x20cm

Tappeto decorazione in rilievo motivo Fiori
Relief decoration mat, Flowers motif

COD. 40-W084 Misure - Sizes: 60x40cm
COD. 40-W151 Misure - Sizes: 40x20cm

Tappeto decorazione in rilievo motivo Quadri
Relief decoration mat, Square motif

COD. 40-W085 Misure - Sizes: 60x40cm
COD. 40-W152 Misure - Sizes: 40x20cm

Tappeto decorazione in rilievo motivo Cerchi
Relief decoration mat, Circle motif

COD. 40-W086 Misure - Sizes: 60x40cm
COD. 40-W153 Misure - Sizes: 40x20cm

Tappeto decorazione in rilievo motivo Floreale
Relief decoration mat, Floreale motif

COD. 40-W142 Misure - Sizes: 60x40cm
COD. 40-W146 Misure - Sizes: 40x20cm

Tappeto decorazione in rilievo motivo Margherite
Relief decoration mat, Daisies motif

COD. 40-W143 Misure - Sizes: 60x40cm
COD. 40-W147 Misure - Sizes: 40x20cm

Tappeto decorazione in rilievo motivo Stelle
Relief decoration mat, Stars motif

COD. 40-W144 Misure - Sizes: 60x40cm
COD. 40-W148 Misure - Sizes: 40x20cm

Tappeto decorazione in rilievo motivo Happy Birthday
Relief decoration mat, Happy Birthday motif

COD. 40-W145 Misure - Sizes: 60x40cm
COD. 40-W149 Misure - Sizes: 40x20cm

MOD.
1

Set 12 attrezzi decoro
Set 12 pcs decoration tools

COD. 40-WA004V

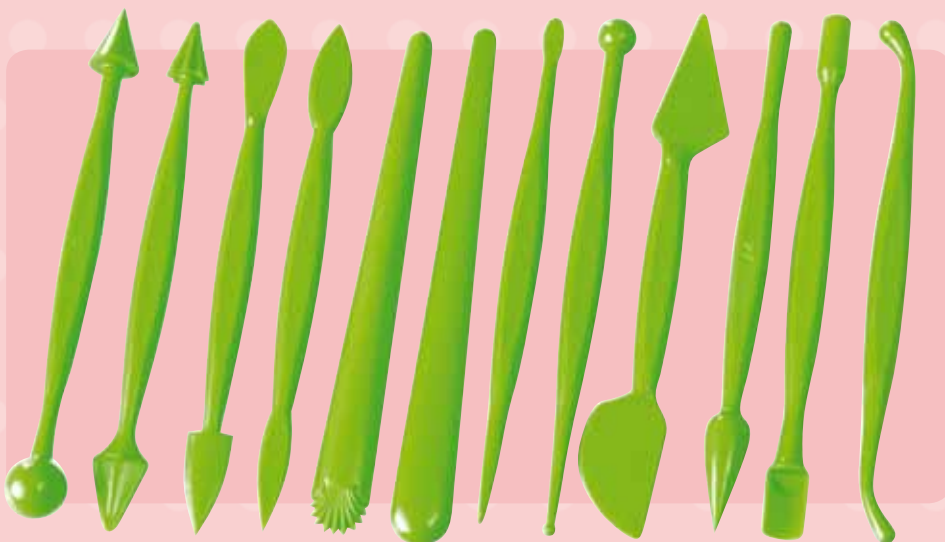

MOD.
2

Set 12 attrezzi decoro
Set 12 pcs decoration tools

COD. 40-WA005V

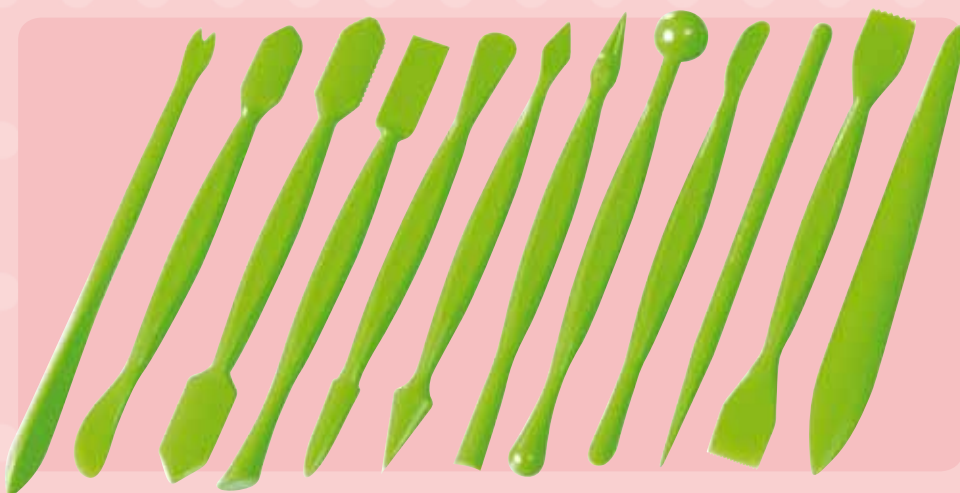

MOD.
4

Valigetta attrezzi decoro
Case decoration tools

COD. 50WA004B



MOD.
5

Valigetta attrezzi decoro
Case decoration tools

COD. 50WA005B

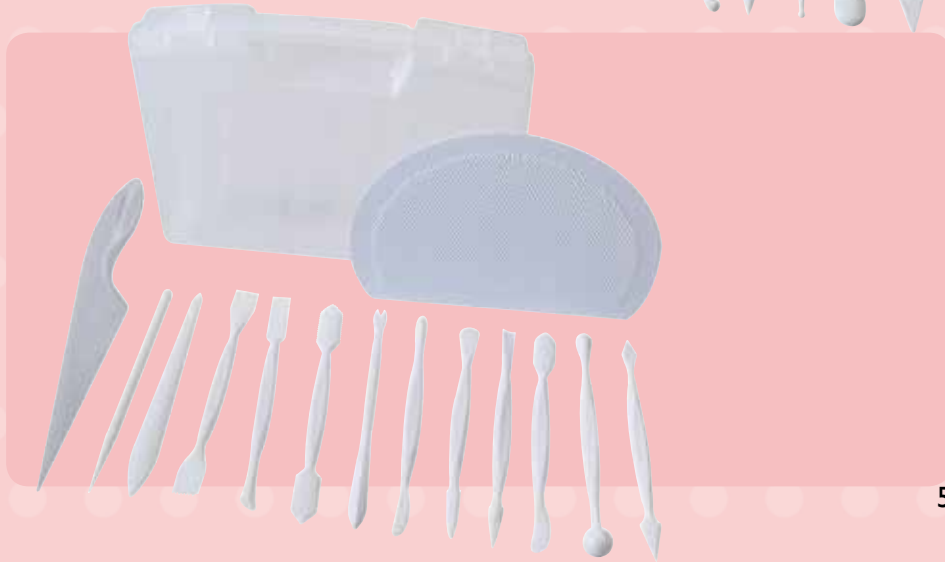

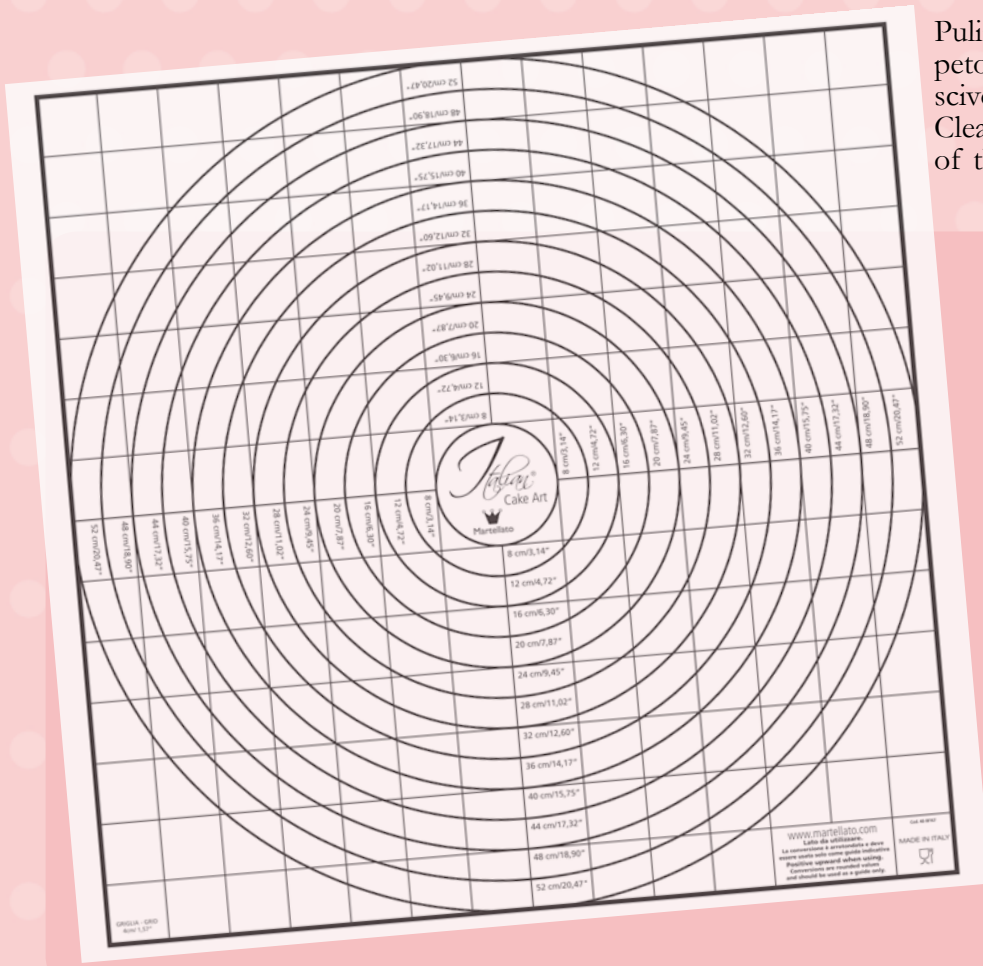

Pulire il tavolo prima di posizionare il tappeto per aumentare la funzionalità dell'antiscivolo.
Clean the table to increase the functionality of the non slip mat.

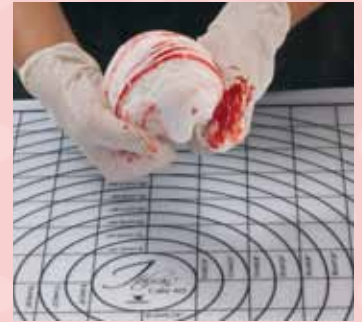

Tappeto stendipasta in plastica - Plastic mat for dough rolling out COD. 40-W167

Tappeto stendipasta in plastica 60x58cm con gommatura antiscivolo
Plastic mat 60x58cm with skidproof

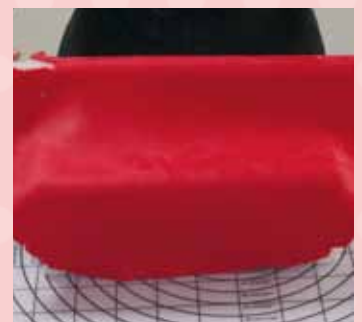
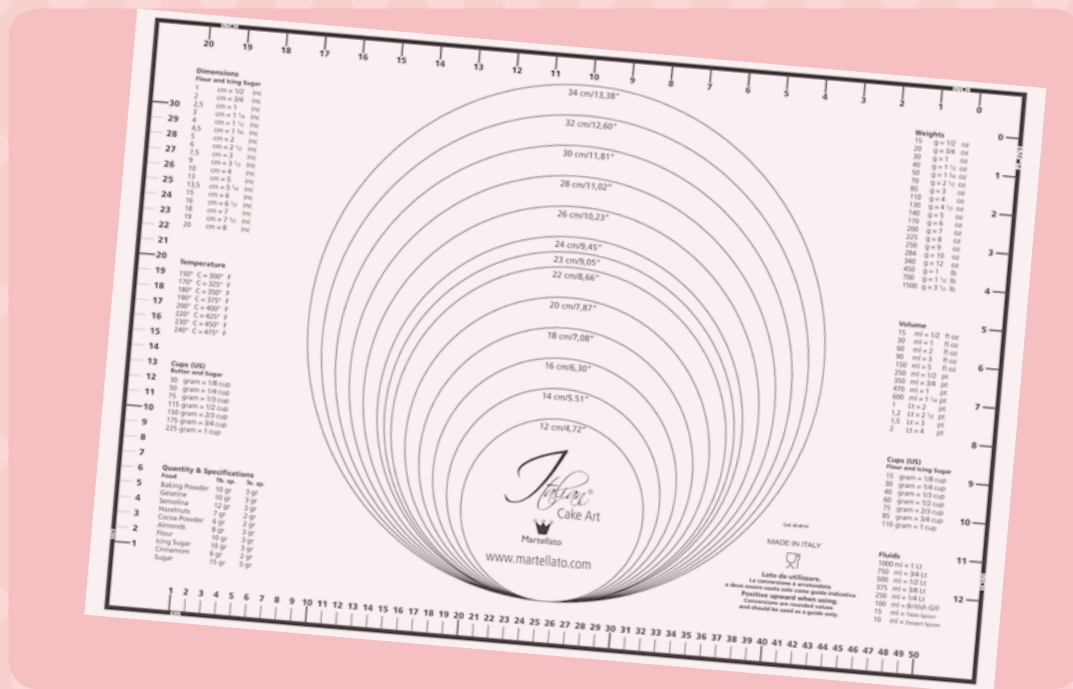

Tappeto stendipasta in plastica - Plastic mat for dough rolling out COD. 40-W141

Tappeto stendipasta in plastica 60x40cm con gommatura antiscivolo
Plastic mat 60x40cm with skidproof



Mattarello Grande

COD. 40-W022

Mattarello grande in teflon
Big Rolling pin made of teflon
Ø45mm - 500mm

Mattarello Medio

COD. 40-W154

Mattarello medio in teflon
Medium Rolling pin made of teflon
Ø45mm - 350mm

Mattarello Piccolo

COD. 40-W021

Mattarello piccolo in teflon
Small Rolling pin made of teflon
Ø25mm - 230mm



Set 8 Anelli - Set 8 Ring

COD. 40-W165A

spessore thickness 4-5-6-10mm
per/for:
40-W022 Ø45mm
40-W154 Ø45mm



Set 8 Anelli - Set 8 Ring

COD. 40-W164A

spessore thickness 4-5-6-10mm
per/for:
40-W021 Ø25mm



Paletta per lisciare Smoother

COD. 40-W004

82x148mm

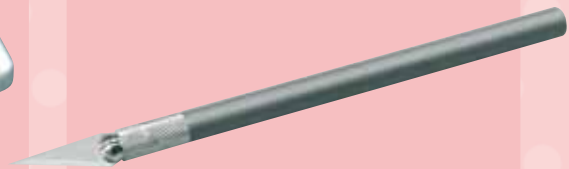

Cutter Bisturi Scalpel bisturi

COD. 40-W031

Bisturi
Scalpel

COD. 40-W031R

Conf. 3 lame ricambio
Pack of 3 spare blades



Kit 4 raschietti Kit 4 plastic scrapers

COD. RTKIT



Tappeto per Fiori Mat for flowers

COD. 40-W139

190x190mm



**Coltello per marzapane e pasta zucchero
Marzipan and fondant knife**

COD. 50WA006B

Bianco - White

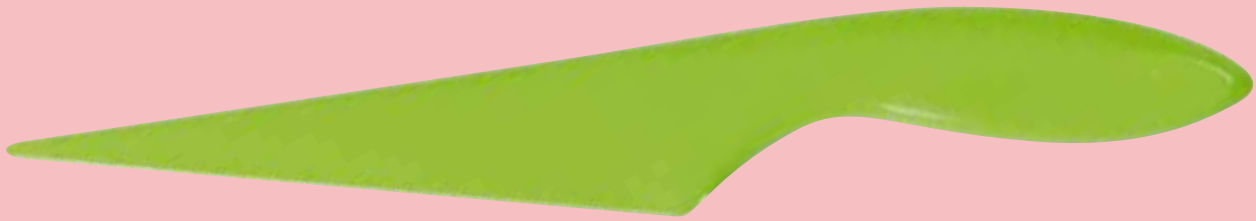

**Coltello per marzapane e pasta zucchero
Marzipan and fondant knife**

COD. 40-WA006V

Verde - Green

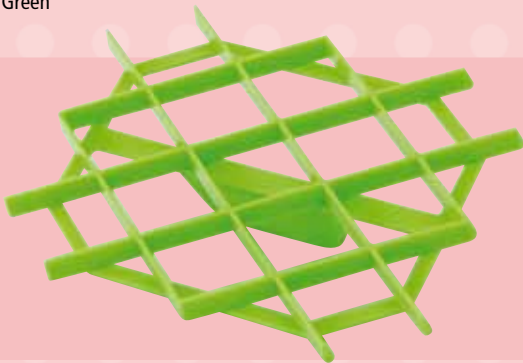

**Cutter effetto imbottitura
Quilted effect cutter**

COD. 40-W198V

Misura-Size: 120x90mm



**Stencil rombi per effetto imbottitura
Rhomb stencil for quilted effect**

COD. 40-W108

Misura-Size: 200x330mm



**Ovali doppio taglio liscio e dentellato
Oval Double cutter smooth and serrated**

COD. 40-W026

Misura-Size:

33x23 - 30x20mm 68x46 - 60x40mm
49x33 - 44x28mm 86x60 - 78x50mm



**Kit 3 rotelline
3 wheels cutter kit**

COD. 40-W052

Pinzette decoro

Set 2 pinzette per decoro.
Set 2 pcs stainless steel pie
crimpers.

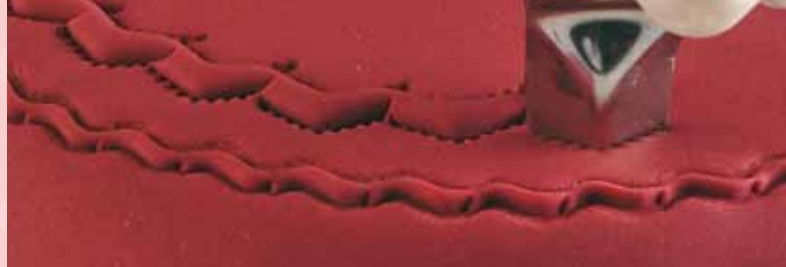
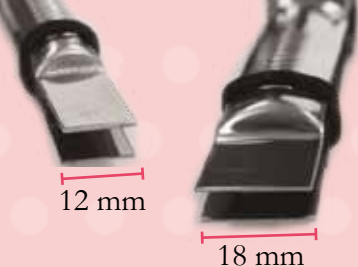

COD. 001 OA D
Dentellato - Serrated



COD. 001 OA L
Liscio - Plain



COD. 002 OC D
Dentellato - Serrated



COD. 002 OC L
Liscio - Plain



COD. 003 VA D
Dentellato - Serrated



COD. 003 VA L
Liscio - Plain



COD. 004 VC D
Dentellato - Serrated



COD. 004 VC L
Liscio - Plain



COD. 005 CA D
Dentellato - Serrated



COD. 005 CA L
Liscio - Plain



COD. 006 CC D
Dentellato - Serrated



COD. 006 CC L
Liscio - Plain



COD. 007 LD D
Dentellato - Serrated



COD. 007 LD L
Liscio - Plain



COD. 008 CU D
Dentellato - Serrated



COD. 008 CU L
Liscio - Plain



COD. 009 AG D
Dentellato - Serrated



COD. 009 AG L
Liscio - Plain



COD. 010 LO D
Dentellato - Serrated



COD. 010 LO L
Liscio - Plain



Quality & Design
MADE IN ITALY

Per tagliare strisce di pasta di varie misure, lisce o ondulate.

Il pantografo agevola e semplifica notevolmente la realizzazione di strisce di pasta zucchero o altri tipi di impasti, garantendo un taglio preciso ed una produzione veloce di fasce della stessa larghezza.

To cut smooth or fluted strips of dough of various sizes.

The small pantograph facilitates and greatly simplifies the realization of strips of sugar paste or other types of dough, ensuring a precise cut and a fast production of strips of the same width.



Pantografo - Pantograph

COD. 40-WA001V

Il kit include:

4 rotelle lisce - 4 coppie di rotelle ondulate
2 distanziatori da 15 mm - 2 distanziatori da 10 mm
4 distanziatori da 5 mm

The kit includes:

4 smooth wheels and 4 couples of fluted wheels
2 spacers 15 mm - 2 spacers 10 mm - 4 spacers 5 mm



Sugar Gun

COD. 40-WA007

Il kit include 20 dischetti intercambiabili
The kit includes 20 interchangeable discs



Strumento ideale per creare bordi e decorazioni varie.
Ideal tool to create edges and various decorations.

CUTTER

Cutter Lettere Letter Cutter

COD. 40-WA002

Kit 5 pz stampi ed espulsori per lettere dalla A alla Z
Letters moulds and plungers kit 5 pcs from A to Z

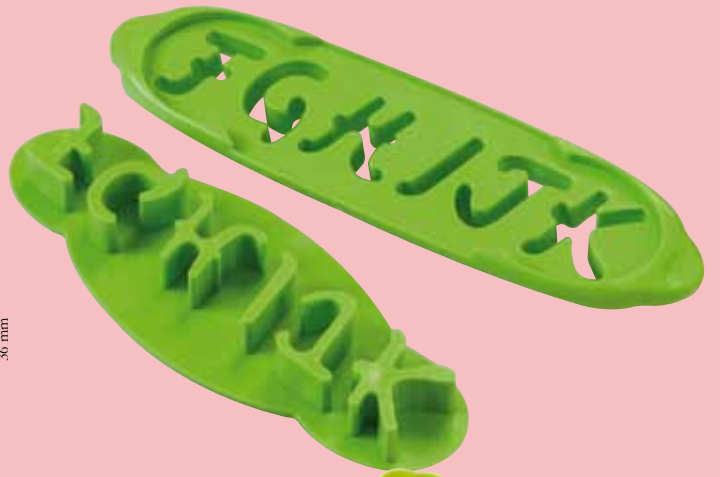
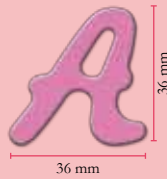

Cutter Letterine Small Letter Cutter

COD. 40-WA008

Il kit include:

Stampi lettere dalla A alla Z (con simboli inclusi)
set 5 pz con espulsori per facilitare l'estrazione delle lettere dopo il taglio.

The kit includes:

Letters cutters from A to Z (with symbols included) set of 5 with extractor to facilitate the extraction of the letters after cutting.



Cutter Numeri Numbers Cutter

COD. 40-WA003

Kit 2 pz stampi ed espulsori per numeri dallo 0 al 9
Numbers moulds and plungers kit 2 pcs from 0 to 9

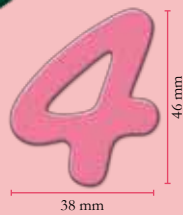

Cutter Numerini Small Numbers Cutter

COD. 40-WA009

Il kit include:

Stampi numeri dallo 0 al 9 set 2 pz con espulsori
per facilitare l'estrazione dei numeri dopo il taglio.

The kit includes:

Numbers cutters from 0 to 9, set of 2 with extractor
to facilitate the extraction
of the numbers after cutting.



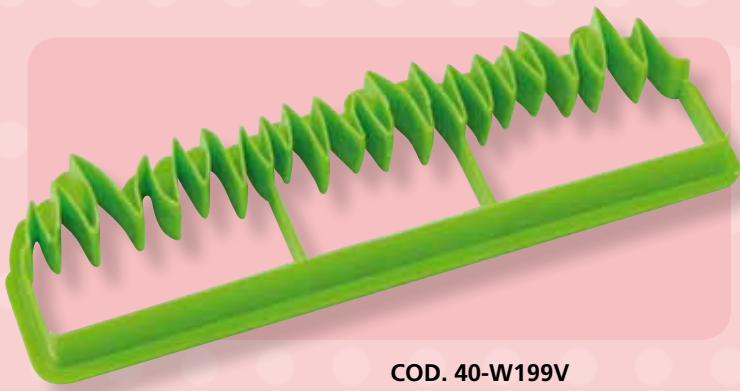

COD. 40-W199V
206x58mm

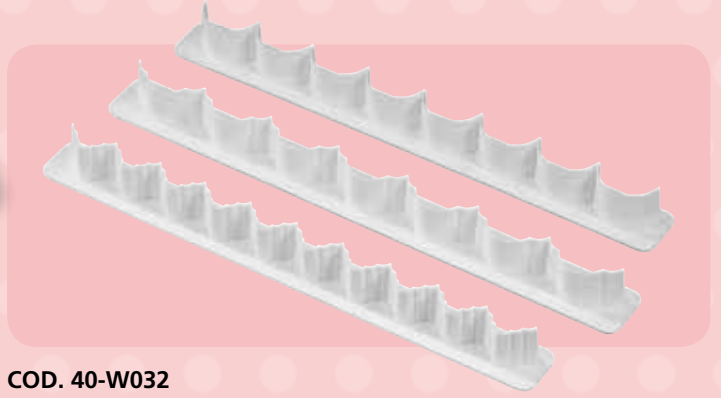

COD. 40-W032
Set 3 pcs - 205x11mm



COD. 40-W137
Set 3 pcs - 205x12mm

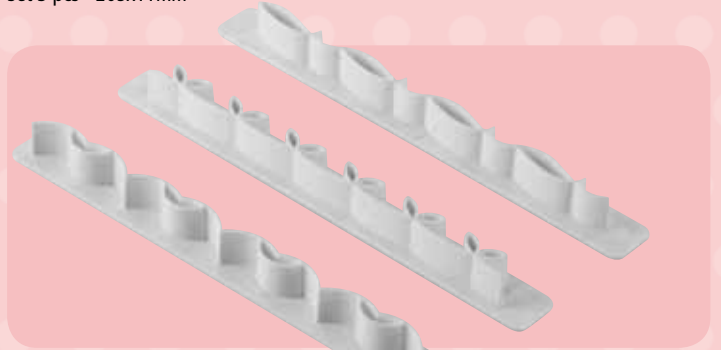

COD. 40-W138
Set 3 pcs - 205x12mm

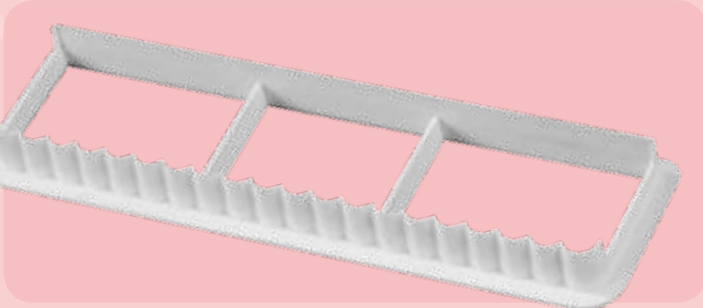

COD. 40-W033
204x50mm

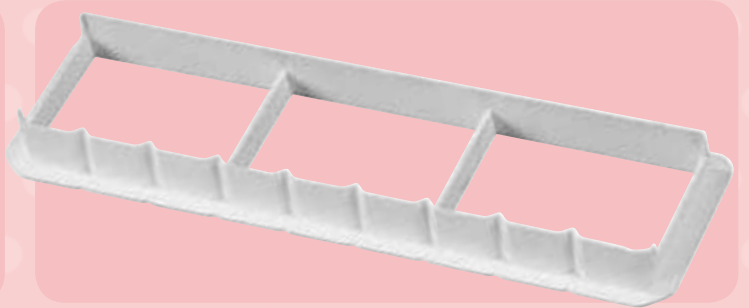

COD. 40-W034
210x50mm

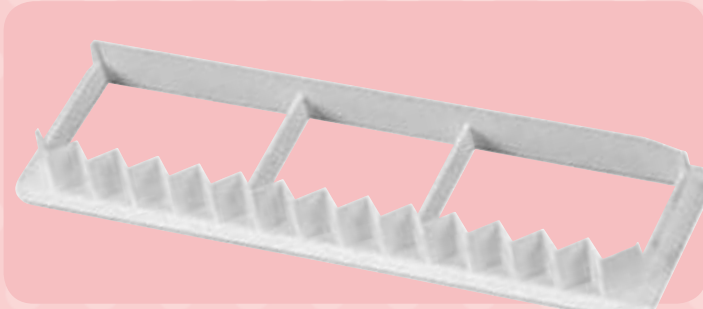

COD. 40-W035
200x50mm



COD. 40-W036
207x50mm



COD. 40-W037
207x50mm

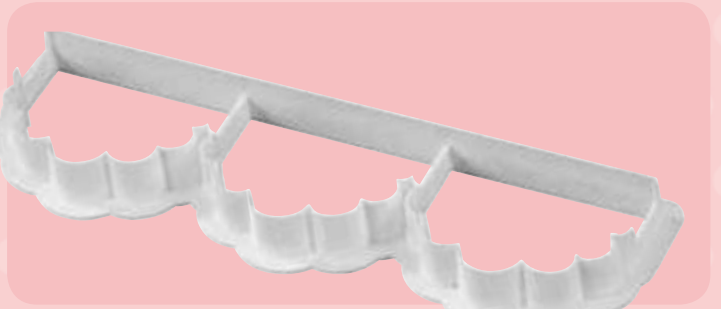

COD. 40-W038
200x50mm



Giratorta inclinabile
Turning stand

COD. 40-W125

Misura-Size:
Ø23cm - h14cm



Giratorta Plastica
Turning stand

COD. GIRA

Misura-Size: Ø32cm - h10cm



Giratorta Plastica
Turning stand

COD. GIRA2

Misura-Size: Ø31cm - h5,5cm



Giratorta Acciaio
Turning stand

COD. GIRA3

Misura-Size: 41x31cm - h9,5cm

STENDI PASTA ROLLING MACHINE



per stendere la pasta a: 1-2-3-4 e 5 mm
Potenza motore monofase: KW 0,25
Alimentazione: 230 1ph 50Hz

To roll out the dough: 1-2-3-4 and 5 mm
Single-phase motor power: KW 0,25
Power supply: 230 1ph 50Hz

COD. 40-W200

45x35,5 - h37,5cm
lunghezza rullo - Roll length: 31cm

COD. 40-W20045

65x35,5 - h37,5cm
lunghezza rullo - Roll length: 45cm

Scocca di protezione in plastica
Plastic protective case

Rullo in teflon - Teflon roller

Manopola regolazione spessore
Thickness adjuster knob

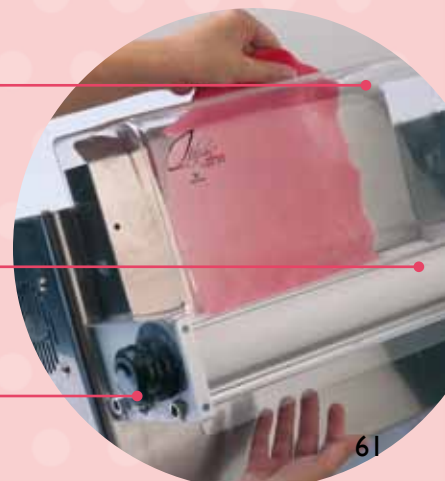

BOCCHETTE PER DECORAZIONI DECORATIONS PIPING TIPS

Conf. 5 pz
Pack 5 pcs



COD. BX0026
Size: Ø18 h 36 mm
Top: 25 mm



COD. BX0027
Size: Ø18 h 36 mm
Top: 25 mm



COD. BX0028
Size: Ø18 h 37 mm
Top: Ø 0,4 mm



COD. BX0029
Size: Ø18 h 35 mm
Top: Ø 0,6 mm



COD. BX0030
Size: Ø18 h 36 mm
Top: Ø 0,9 mm



COD. BX0031
Size: Ø18 h 34 mm
Top: Ø4 mm



COD. BX0032
Size: Ø18 h 34 mm
Top: Ø2 mm



COD. BX0033
Size: Ø18 h 33 mm
Top: Ø4 mm



COD. BX0034
Size: Ø18 h 33 mm
Top: Ø5 mm



COD. BX0035
Size: Ø18 h 35 mm
Top: 4 mm



COD. BX0036
Size: Ø18 h 35 mm
Top: 6 mm



COD. BX0037
Size: Ø18 h 33 mm
Top: 8 mm



COD. BX0038
Size: Ø18 h 28 mm
Top: Ø8 mm



COD. BX0039
Size: Ø18 h 32 mm
Top: Ø5 mm



COD. BX0040
Size: Ø18 h 30 mm
Top: Ø6 mm



COD. BX0041
Size: Ø18 h 34 mm
Top: 10 mm



COD. BX0042
Size: Ø18 h 30 mm
Top: Ø6 mm



COD. BX0043
Size: Ø18 h 28 mm
Top: 108 mm



COD. BX0044
Size: Ø18 h 28 mm
Top: Ø8 mm



COD. BX0045
Size: Ø18 h 31 mm
Top: Ø7 mm



COD. BX0046
Size: Ø18 h 30 mm
Top: Ø10 mm



COD. BX0047
Size: Ø18 h 26 mm
Top: Ø9 mm



COD. BX0048
Size: Ø18 h 30 mm
Top: Ø10mm



COD. BX0049
Size: Ø18 h 30 mm
Top: Ø7 mm



COD. BX0050
Size: Ø18 h 24 mm
Top: Ø10 mm



COD. BX0001
Size: Ø37 h 42 mm
Top: Ø23 mm



COD. BX0002
Size: Ø37 h 42 mm
Top: Ø23 mm



COD. BX0004
Size: Ø37 h 42 mm
Top: Ø25 mm



COD. BX0006
Size: Ø37 h 42 mm
Top: Ø25 mm



COD. BX0008
Size: Ø37 h 42 mm
Top: Ø25 mm



COD. BX0009
Size: Ø37 h 42 mm
Top: Ø23 mm



COD. BX0011
Size: Ø37 h 42 mm
Top: Ø23 mm



COD. BX0012
Size: Ø37 h 42 mm
Top: Ø23 mm



COD. BX0014
Size: Ø37 h 42 mm
Top: Ø25 mm



COD. BX0016
Size: Ø37 h 42 mm
Top: Ø25 mm



COD. BX0017
Size: Ø37 h 42 mm
Top: Ø25 mm



COD. BX0023
Size: Ø37 h 42 mm
Top: Ø25 mm



COD. BX0051
Size: Ø35 h 38 mm
Top: Ø25 mm



COD. BX0052
Size: Ø35 h 38 mm
Top: Ø25 mm



COD. BX0053
Size: Ø35 h 38 mm
Top: Ø25 mm



COD. BX0054
Size: Ø37 h 42 mm
Top: Ø25 mm



COD. BX0055
Size: Ø37 h 42 mm
Top: Ø25 mm



COD. BX0056
Size: Ø37 h 42 mm
Top: Ø25 mm



COD. BX0057
Size: Ø37 h 42 mm
Top: Ø25 mm



COD. BX0058
Size: Ø37 h 42 mm
Top: Ø25 mm



COD. BX0059
Size: Ø37 h 42 mm
Top: Ø25 mm



COD. BX0060
Size: Ø37 h 42 mm
Top: Ø25 mm



COD. BX0061
Size: Ø37 h 42 mm
Top: Ø25 mm

BOCCHETTE DECORAZIONI DECORATIONS PIPING TIPS



COD. BX0100
Size: Ø32 h 60 mm
Top: Ø22 mm
pack 1 pc



COD. BX0101
Size: Ø32 h 57 mm
Top: Ø22 mm
pack 1 pc



COD. BX0102
Size: Ø32 h 57 mm
Top: Ø22 mm
pack 1 pc



COD. BX0103
Size: Ø32 h 57 mm
Top: Ø22 mm
pack 1 pc



COD. BX0104
Size: Ø32 h 57 mm
Top: Ø22 mm
pack 1 pc



COD. BXB01
Size: Ø55 h 60 mm
Top: Ø31 mm
pack 1 pc



COD. BXB02
Size: Ø55 h 56 mm
Top: Ø31 mm
pack 1 pc

Bi & Tri COLOR



COD. 40-WA010

Kit di adattatori, per realizzare decorazioni a due o tre colori.
Adapter kit suitable to prepare decorations with two or three colours.
pack 2 pcs

Adatto a bocchette / Suitable for piping tips:
Ø30 h 50 mm



COD. ESPOB60

Size: 515x315 h210mm

Espositore in plexiglass con crowner per 60 bocchette
Plexiglass display with crowner for 60 piping tips



COD. ESPOB032

Size: 310x100 h390mm

Portabocchette in plexiglass per 32 pz
Plexiglass piping tips holder for 32 pcs

PASTA ZUCCHERO E COLORANTI ALIMENTARI

SUGAR PASTE AND FOOD COLOURS

MADE IN ITALY

Bianco Fondant

Grazie alla sua elasticità, resistenza e stabilità è ideale per la copertura di dolci da ricorrenza anche di grandi dimensioni.

Con il Bianco Fondant è possibile produrre fiori, foglie e decorazioni varie utilizzando le tecniche tradizionali che prevedono tempi di asciugatura più lunghi.

Thanks to its elasticity, strength and stability it is ideal for covering cakes even of big dimensions.

Bianco Fondant is ideal to produce flowers, leaves and various decorations using traditional techniques that require longer drying times.



COD.	Colore	Gr	Info
EFF000	Bianca - White	5000gr	Azo free
EFF001	Bianca - White	1000gr	Azo free

CMC

COD. 40-W042

Barattolo 40gr
Jar 40gr

Additivo alimentare utilizzato come addensante. Aggiunto alla pasta zucchero si ottiene una pasta più resistente e più facile da modellare. Prodotto inodore e insapore.

Food additive used as a thickener. If added to sugarpaste, you will get a more resistant and easier to shape dough. Odorless and tasteless.



Colla - Glue

COD. 40-W166

Barattolo 25gr
Jar 25gr



Coloranti Gel Gel colours

Colorante in gel ad altissima concentrazione, speciale per le colorazioni di pasta zucchero, masse grasse e royal ice.

Highly concentrated colour in gel for the colouring of sugar paste, fat masses and royal icing.

COD.	Colore	Gr	Info
LCG001	Arancione - Orange	30gr	Azo
LCG002	Blu - Blue	30gr	Azo free
LCG004	Giallo - Yellow	30gr	Azo
LCG005	Marrone - Brown	30gr	Azo
LCG006	Nero - Black	30gr	Azo
LCG007	Rosa - Pink	30gr	Azo
LCG008	Rosso - Red	30gr	Azo
LCG009	Verde - Green	30gr	Azo
LCG010	Violet - Violet	30gr	Azo
LCG022	Blue Navy	30gr	Azo
LCG025	Incarnato - Incarnate	30gr	Azo



Sugar Dress

Un sistema facile e veloce per ottenere un decoro raffinato e di grande effetto. È sufficiente aggiungere ai due preparati dell'acqua, mescolare bene il composto e spalmarlo con una spatola nell'apposito tappetino Martellato.

An easy and fast way to get a refined and impressive decoration.

It's enough just to add some water to the two preparations, mix well and spread the mixture with a spatula into the Martellato mat.



COD. EFSD001
SUGAR DRESS Bianca - White
Secchiello 500 gr
Bucket 500 gr
GLUTEN FREE



COD. EFSD002
SUGAR DRESS Bianca - White
Secchiello 200 gr
Bucket 200 gr
GLUTEN FREE



COD. EFSD006
SUGAR DRESS Nero - Black
Secchiello 200 gr
Bucket 200 gr
GLUTEN FREE

Sugar Pearl

Pronte all'uso.

Mescolare bene prima dell'uso. Stendere il composto sugli stampi facendolo aderire perfettamente aiutandosi con una spatola.

Ready for use!

Mix well before using.

Pour the product into the mould and let it penetrate deeply with the help of a palette knife.



COD. EFSP002
SUGAR PEARL
Blu - Blue
Secchiello - Bucket
200 gr - AZO



COD. EFSP007
SUGAR PEARL
Rosa - pink
Secchiello - Bucket
200 gr - AZO FREE



COD. EFSP008
SUGAR PEARL
Rosso - Red
Secchiello - Bucket
200 gr - AZO FREE



COD. EFSP010
SUGAR PEARL
Viola - Violet
Secchiello - Bucket
200 gr - AZO



COD. EFSP017
SUGAR PEARL
Oro - Gold
Secchiello - Bucket
200 gr - AZO FREE



COD. EFSP019
SUGAR PEARL
Argento - Silver
Secchiello - Bucket
200 gr - AZO FREE



COD. EFSP025
SUGAR PEARL
Avorio - Ivory
Secchiello - Bucket
200 gr - AZO



Pennarelli Marking pens

COD. 40-WC100

Kit 8 Color Azo Free



Ideali per prodotti di pasticceria come cialde, pasta da zucchero, confetti, biscotti e wafer.

Arancione, verde, nero, giallo, azzurro, rosso, rosa, marrone.

Ideal for confectionary products such as wafers, sugar pastry, sugared almonds, biscuits and marzipan.

Orange, green, black, yellow, blue, red, pink and brown.

Gelatine Jellies

La gelatina ad uso alimentare è ideale per guarnire le torte e dare un effetto di lucentezza.

Food jellies are ideal to garnish every kind of cake.



COD.	Colore	Gr	Info
LCJ000	Transparent	1000 gr	Azo free
LCJ100	Glitter Transparent	1000 gr	Azo free

CONSIGLI D'USO DIRECTIONS FOR USE

Una volta ammorbidita con la frusta, la gelatina va stesa sulla superficie della torta per dare un effetto lucido e glassato.

Soften the jelly with a whisk, and then spread it onto the cake surface to produce a shiny effect.

Coloranti polvere Lacche Lake powder colours

Il colorante alimentare **liposolubile** può essere utilizzato in tutte le masse grasse come cioccolato, burro di cacao, pasta frolla, marzapane, pasta di zucchero etc..

The food **liposoluble** colour can be used in all fat masses: chocolate, cocoa butter, short pastry, marzipan, sugar paste.



Coloranti polvere Perlato Pearled powder colours

Il colorante alimentare in polvere **liposolubile e alcool solubile**, può essere usato per la decorazione di praline e soggetti di cioccolato, torte glassate, semifreddi, gelato, mousse, gelatina trasparente ecc.

The food **liposoluble and alcohol soluble** powder colour can be used for decorating pralines or other subjects of chocolate, frozen cakes, semifreddi, ice cream, mousse, transparent gelatin.



Coloranti polvere Powder colours

Colorante alimentare in polvere **idrosolubile** ad elevato grado di purezza, utilizzabile in qualsiasi tipo di impasto (per la colorazione del cioccolato si consiglia di utilizzare la linea "Lake Powder" o "Pearled Powder").

High purity **water-soluble** food coloring powder to be used in any type of dough (to colour the chocolate you should use the line "Lake Powder" or "Pearled Powder").

COD.	Colore	Gr	Info
40-WC300	Bianco - White	5 gr	Azo free
40-WC302	Blu - Blue	5 gr	Azo free
40-WC304	Giallo - Yellow	5 gr	Azo free
40-WC305	Marrone - Brown	5 gr	Azo free
40-WC306	Nero - Black	5 gr	Azo free
40-WC307	Rosa - Pink	5 gr	Azo free
40-WC308	Rosso - Red	5 gr	Azo free
40-WC309	Verde - Green	5 gr	Azo free
40-WC310	Viola - Violet	5 gr	Azo free
40-WC311	Arancione - Orange	5 gr	Azo free
40-WC322	Candy pink	5 gr	Azo free

COD.	Colore	Gr	Info
LCP300	Bianco - White	25 gr	Azo free
LCP302	Blu - Blue	25 gr	Azo free
LCP304	Giallo - Yellow	25 gr	Azo
LCP305	Marrone - Brown	20 gr	Azo
LCP306	Nero - Black	25 gr	Azo free
LCP307	Rosa - Pink	25 gr	Azo free
LCP308	Corallo - Coral	25 gr	Azo
LCP308N	Rosso - Red	25 gr	Azo
LCP309	Verde - Green	25 gr	Azo
LCP311	Arancione - Orange	25 gr	Azo

COD.	Colore	Gr	Info
40-WC015	Bronzo - Bronze	5 gr	Azo free
40-WC017	Oro lustre - Gold	5 gr	Azo free
40-WC020	Rame - Copper	5 gr	Azo free
40-WC119	Argento - Silver	5 gr	Azo free

COD.	Colore	Gr	Info
LCP003	Blu - Blue	25 gr	Azo free
LCP008	Rosso - Red	25 gr	Azo
LCP009	Verde - Green	25 gr	Azo
LCP010	Viola - Violet	25 gr	Azo
LCP015	Bronzo - Bronze	25 gr	Azo free
LCP017N	Gold LUSTRE	25 gr	Azo free
LCP018	Rubino - Ruby	25 gr	Azo free
LCP019N	Silver LUSTRE	25 gr	Azo free
LCP020	Rame - Copper	25 gr	Azo free
LCP021	Fucsia - Fuchsia	25 gr	Azo
LCP117	Oro - Gold	25 gr	Azo free
LCP119	Argento - Silver	25 gr	Azo free

COD.	Colore	Gr	Info
LCP202	Blu - Blue	25 gr	Azo free
LCP204	Giallo - Yellow	25 gr	Azo
LCP206	Nero - Black	25 gr	Azo free
LCP208	Rosso - Red	25 gr	Azo
LCP209	Verde - Green	25 gr	Azo
LCP211	Arancione - Orange	25 gr	Azo
LCP218	Fragola - Strawberry	25 gr	Azo



CONSIGLI D'USO DIRECTIONS FOR USE

Non essendo idrosolubile può essere sciolto con altri grassi come burro margarina etc.. per essere poi versato nell'impasto da colorare. Se utilizzato per la colorazione del cioccolato può essere versato direttamente nel cioccolato fuso. E' possibile la colorazione a pennello se sciolti con alcool.

This powder is not watersoluble therefore it can be mixed with other fats like butter or margarine, and then it can be poured in the dough to be colored. When used for coloring the chocolate, it can be poured directly into the melted chocolate. It is possible to colour by using a brush if dissolved in alcohol.

CONSIGLI D'USO DIRECTIONS FOR USE

Il colorante è solubile in alcool, operazione consigliata o in acqua operazione più faticosa. Grazie alla capacità di riflettere la luce dona alla decorazione un effetto metallizzato. Può essere usato direttamente sulla superficie di cioccolato, senza essere sciolto, con un pennello o con le dita ottenendo così un effetto perlato.

The colour is soluble in alcohol (suggested operation) or in water (more difficult operation). Thanks to the ability to reflect the light, this powder gives the decoration a metallic effect. It can be used directly on the surface of the chocolate, without being dissolved, with a brush or with fingers obtaining in this way a pearled effect.

CONSIGLI D'USO DIRECTIONS FOR USE

Il colorante può essere sciolto con l'aggiunta di acqua. La grana più fine facilita e velocizza lo scioglimento della polvere.

The colour can be dissolved with the addition of water. The finer is the grain the more rapid is the dissolution of the powder.

Colori Spray - Pastello Spray colours - Pastel

Coloranti alimentari pastello **idroalcolici** in bombolette spray.

Ideali per la colorazione di masse grasse, cioccolato, marzapane, biscotteria, cialde, zucchero tirato soffiato e colato, pasta di zucchero, semifreddi, mousse, gelato, pastigliaggio e pasticceria generale.

Pastel **hydroalcoholic** food colors in spray cans.

Ideal for the decoration of fat masses, chocolate, marzipan, biscuits, waffles, pulled sugar, candy floss, poured sugar, sugar paste, semifreddi, mousses, ice-cream, pastry in general.



COD. Colore MI Info

LCS001	Arancione - Orange	100 ml	Azo
LCS003	Azzurro - Sky blue	100 ml	Azo free
LCS004	Giallo - Yellow	100 ml	Azo
LCS005	Bruno - Brown	100 ml	Azo
LCS007	Rosa - Pink	100 ml	Azo
LCS008	Rosso - Red	100 ml	Azo
LCS009	Verde - Green	100 ml	Azo

CONSIGLI D'USO DIRECTIONS FOR USE

Agitare il prodotto prima dell'uso, mantenersi ad una distanza di circa 15 cm.

Non spruzzare in quantità eccessiva per non rischiare di causare macchie indesiderate.

Lasciare asciugare per qualche secondo prima di spruzzare nuovamente sul prodotto da decorare.

Shake the product before use, keep at a distance of about 15 cm. Do not spray too much in order to avoid unwanted stains.

Allow to dry for a few seconds before spraying again on the product to be decorated.

Colori Spray - Perlati Spray colours - Pearl

Coloranti alimentari perlati **idroalcolici** in bombolette spray, decorazione colorata dall'effetto perlato.

Ideali per la colorazione di masse grasse, cioccolato, marzapane, biscotteria, cialde, zucchero tirato soffiato e colato, pasta di zucchero, semifreddi, mousse, gelato, pastigliaggio e pasticceria generale.

Pearled **hydroalcoholic** food colors in spray cans, colored decoration with pearled effect. Ideal for the decoration of fat masses, chocolate, marzipan, biscuits, waffles, pulled sugar, candy floss, poured sugar, sugar paste, semifreddi, mousses, ice-cream, pastry in general.



COD. Colore Gr Info

LCS215	Bronzo - Bronze	100 ml	Azo free
LCS217N	Oro - Gold	100 ml	Azo free
LCS218N	Rubino - Ruby	100 ml	Azo free
LCS219N	Argento - Silver	100 ml	Azo free
LCS220	Rame - Copper	100 ml	Azo free

CONSIGLI D'USO DIRECTIONS FOR USE

Agitare il prodotto prima dell'uso, mantenersi ad una distanza di circa 15 cm.

Non spruzzare in quantità eccessiva per non rischiare di causare macchie indesiderate.

Lasciare asciugare per qualche secondo prima di spruzzare nuovamente sul prodotto da decorare.

Shake the product before use, keep at a distance of about 15 cm. Do not spray too much in order to avoid unwanted stains.

Allow to dry for a few seconds before spraying again on the product to be decorated.

Lucidante Spray Shiny Spray

COD. LCV100

Azo free 400 ml

Lucidante alimentare neutro a base di burro di cacao ideale per proteggere e lucidare marzapane e pasta di mandorle.

Neutral Food Polishing composed of cocoa butter, ideal for protecting and polishing marzipan and almond paste



Refrigerante Spray Cooler Spray

COD. EUROCHOCK

Azo free 400 ml

Refrigerante in spray, con cannuccia unidirezionale, per la presa istantanea di particolari in cioccolato o zucchero.

Spray cooler, with monodirection straw, enables to fix chocolate and sugar pieces.



Staccante Spray Coating Spray

COD. COATING

Azo free 400 ml

Staccante alimentare ideale per velocizzare la rimozione del prodotto da teglie o cinture in acciaio e alluminio, stampi semifreddo, termoformati o altro. Il prodotto è inodore e insapore.

Detaching ideal for removing easily the product from mould trays, steel belts, aluminium moulds, thermoformed moulds and other. The product is odourless and tasteless.



Lucidanti Alimentari Food polishing

COD.

LCA5100 Azo free 100 gr - for airbrush

LCS200 Azo free 400 ml - Spray



Agitare la bomboletta e spruzzare uniformemente ad una distanza di circa 15-20 cm.

Shake the can and spray evenly at a distance of about 15-20 cm

Coloranti per Aerografo Colours for Airbrush

Il colorante alimentare **idrosolubile** "Air Brush" è adatto a qualsiasi tipo di impasto o alimento come: semifreddi, mousse, glasse, panna, pasta frolla, pasta di zucchero, pastigliaggio, marzapane e prodotti di pasticceria in genere.

Non è consigliato l'uso sul cioccolato o altre masse grasse.

The **water-soluble** food colors "Air Brush" are suitable for any type of dough or food such as ice creams, mousses, icings, cream, shortpastry, sugarpaste, marzipan and pastries in general.

It's not recommended for use on chocolate or other fat masses.

Perlati per Aerografo Pearl Colours for Airbrush

Prodotto **idrosolubile** adatto a qualsiasi tipo di impasto o alimento come: semifreddi, mousse, glasse, panna, pasta frolla, pasta di zucchero, pastigliaggio, marzapane e prodotti di pasticceria in genere. Dona un effetto perlescente alle superfici aerografate.

Non è consigliato l'uso sul cioccolato o altre masse grasse.

Water-soluble product suitable for any type of dough or food such as ice creams, mousses, icings, cream, short pastry, sugarpaste, marzipan and pastries in general.

Gives a pearlescent effect to surfaces decorated with airbrush.

It's not recommended for use on chocolate or other fat masses.

Velvet Spray

I coloranti alimentari spray Velvet, a base di burro di cacao, offrono al semifreddo un decoro dall'effetto vellutato. L'articolo può essere spruzzato su tutte le superfici congelate: semifreddi, mousse, torte gelato, cioccolato, creme etc

The Velvet food coloring spray, made with cocoa butter, offer a velvety decor for semifreddi.

The product can be sprayed on all frozen surfaces: semifreddi, mousses, ice cream cakes, chocolate, creams.

COD.	Colore	Ml	Info
LCV000	Bianco - White	400ml	Azo free
LCV001	Arancione - Orange	400ml	Azo
LCV003	Azzurro - Sky blue	400 ml	Azo free
LCV004	Giallo - Yellow	400ml	Azo
LCV005N	Ciocc. al Latte - Milk choc.	400ml	Azo
LCV107	Fucsia - Fuchsia	400ml	Azo
LCV008	Rosso - Red	400ml	Azo
LCV009N	Verde - Green	400ml	Azo
LCV015N	Ciocc. fondente - Dark choc.	400ml	Azo

COD.	Colore	Gr	Info
40-WC600	Bianco - White	45 gr	Azo free
40-WC601	Arancione - Orange	45 gr	Azo
40-WC602	Blu - Blue	45 gr	Azo free
40-WC603	Azzurro - Sky blue	45 gr	Azo free
40-WC604	Giallo - Yellow	45 gr	Azo
40-WC605	Marrone - Brown	45 gr	Azo
40-WC606	Nero - Black	45 gr	Azo
40-WC607	Rosa - Pink	45 gr	Azo
40-WC608	Rosso - Red	45 gr	Azo
40-WC609	Verde - Green	45 gr	Azo
40-WC610	Viola - Violet	45 gr	Azo
40-WC611	Limone - Lemon	45 gr	Azo
40-WC612	Pistacchio - Pistachio	45 gr	Azo

COD.	Colore	Gr	Info
LCA000	Bianco - White	190 ml	Azo free
LCA001	Arancione - Orange	190 ml	Azo
LCA002	Blu - Blue	190 ml	Azo free
LCA003	Azzurro - Sky blue	190 ml	Azo free
LCA004	Giallo - Yellow	190 ml	Azo
LCA005	Marrone - Brown	190 ml	Azo
LCA006	Nero - Black	190 ml	Azo
LCA007N	Rosa - Pink	190 ml	Azo
LCA008N	Rosso - Red	190 ml	Azo
LCA009	Verde - Green	190 ml	Azo
LCA010	Viola - Violet	190 ml	Azo
LCA011	Limone - Lemon	190 ml	Azo
LCA012	Pistacchio - Pistachio	190 ml	Azo

COD.	Colore	Gr	Info
40-WC617	Oro - Gold	45 gr	Azo free
40-WC619	Argento - Silver	45 gr	Azo free

COD.	Colore	Gr	Info
LCA201	Arancione - Orange	190 ml	Azo
LCA203	Azzurro - Sky blue	190 ml	Azo free
LCA205	Marrone - Brown	190 ml	Azo
LCA206	Nero - Black	190 ml	Azo
LCA207N	Rosa - Pink	190 ml	Azo
LCA208N	Rosso - Red	190 ml	Azo
LCA209	Verde - Green	190 ml	Azo
LCA210	Viola - Violet	190 ml	Azo
LCA211	Limone - Lemon	190 ml	Azo
LCA212	Pistacchio - Pistachio	190 ml	Azo
LCA217	Oro - Gold	190 ml	Azo free
LCA219	Argento - Silver	190 ml	Azo free

CONSIGLI D'USO DIRECTIONS FOR USE

Versare il colorante nel prodotto in base alla gradazione di colore che si vuole ottenere. In caso di utilizzo del colorante con aerografo si consiglia, a lavoro terminato, di lavare la penna seguendo le istruzioni dei tutorial sul nostro canale YouTube.

Pour the colouring into the product according to the desired shade of colour. In case of use of colouring with an airbrush, it is recommended to wash the pen after use, following the instructions of the tutorials on our YouTube channel.

CONSIGLI D'USO DIRECTIONS FOR USE

Versare il colorante nel prodotto in base alla gradazione di colore che si vuole ottenere.

In caso di utilizzo del colorante con aerografo si consiglia, a lavoro terminato, di lavare la penna con acqua calda, qualora rimanesse residuo di colore secco utilizzare alcool a 90°.

Pour the color in the product according to the shade of colour you want to obtain. In case of use of the dye with an airbrush, it is recommended at the end of work to wash the pen with hot water. In case any residuals of colour remain, use alcohol at 90°.

Il prodotto su cui si spruzza il Velvet deve essere congelato. Agitare bene prima dell'uso. Spruzzare uno strato sottile ed omogeneo di prodotto sulla superficie congelata che si vuole trattare da una distanza di circa 15/20 cm ad intervalli regolari. Ruotare costantemente il dolce mentre si spruzza la decorazione Velvet in modo da distribuire uniformemente il prodotto.

It is essential that the surface is frozen. Shake well before use. Spray a thin, uniform layer on the product from a distance of about 15-20 cm at regular intervals. Constantly rotate the cake while decorating with Velvet to evenly distribute the product.

SPECIAL FOR CHOCOLATE

Satinati per Aerografo Satin for Airbrush

Il colorante alimentare "Satinato per Aerografo" è un prodotto **idroalcolico** con capacità coprente, adatto in particolar modo alla colorazione del cioccolato e pasta zucchero. **Dona un effetto satinato opaco.**

The colour "Satin for Airbrush" is a **hydroalcoholic** product that can easily cover chocolate or sugar paste.

It gives a matt effect.

COD.	Colore	Gr	Info
LCA300	Bianco - White	60 gr	Azo free
LCA303	Azzurro - Skyblue	60 gr	Azo free
LCA304	Giallo - Yellow	60 gr	Azo free
LCA307	Rosa - Pink	60 gr	Azo free
LCA308	Rosso - Red	60 gr	Azo free
LCA309	Verde - Green	60 gr	Azo free

COD.	Colore	Gr	Info
40-WCA301	Arancio - Orange	40gr	Azo free
40-WCA303	Azzurro - Skyblue	40gr	Azo free
40-WCA304	Giallo - Yellow	40gr	Azo free
40-WCA306	Nero - Black	40gr	Azo free
40-WCA308	Rosso - Red	40gr	Azo free
40-WCA326	Verde lime - Lime green	40gr	Azo free

SPECIAL FOR CHOCOLATE

Perlati per Aerografo Pearl for Airbrush

Il colorante alimentare "Perlato per Aerografo" è un prodotto **idroalcolico** con capacità coprente, adatto in particolar modo alla colorazione del cioccolato e pasta zucchero.

Dona un effetto perlato.

The colour "Air Brush Pearl" is a **Hydroalcoholic** product that can easily cover chocolate or sugar paste.

It gives a pearlescent effect.

COD.	Colore	Gr	Info
LCA408	Rosso - Red	100 gr	Azo free
LCA417	Oro - Gold	100 gr	Azo free
LCA419	Argento - Silver	100 gr	Azo free

COD.	Colore	Gr	Info
40-WCA417	Oro - Gold	40gr	Azo free
40-WCA419	Argento - Silver	40gr	Azo free

SPECIAL FOR CHOCOLATE

Burro Cacao Cocoa Butter

I coloranti a base di burro di cacao, una volta sciolti a bagnomaria o microonde, risultano perfetti per la colorazione di prodotti di cioccolato e altre masse grasse.

Colourings composed of cocoa butter, once melted in water bath or microwave, are perfect for colouring chocolate products.

COD.	Colore	Gr	Info
LCB200	Bianco - White	200 gr	Azo free
LCB201	Arancio - Orange	200 gr	Azo
LCB202	Blu - Blue	200 gr	Azo free
LCB204	Giallo - Yellow	200 gr	Azo
LCB206	Nero - Black	200 gr	Azo
LCB208	Rosso - Red	200 gr	Azo
LCB209	Verde - Green	200 gr	Azo
LCB210	Viola - Violet	200 gr	Azo

COD.	Colore	Gr	Info
40-WCB200	Bianco - White	30 gr	Azo free
40-WCB201	Arancio - Orange	30 gr	Azo
40-WCB202	Blu - Blue	30 gr	Azo free
40-WCB204	Giallo - Yellow	30 gr	Azo
40-WCB206	Nero - Black	30 gr	Azo
40-WCB208	Rosso - Red	30 gr	Azo
40-WCB210	Viola - Violet	30 gr	Azo
40-WCB217	Oro - Gold	30 gr	Azo free

SPECIAL FOR CHOCOLATE

Polvere Interferenziale Interference powder

Le polveri interferenziali, se associate ad una superficie scura, donano dei riflessi di luce colorata.

Possono essere usate su soggetti di cioccolato fondente o paste zucchero colorate.

The interference powders, when applied on a dark surface, give some colored light reflections.

They can be used on dark chocolate subjects or colored sugar paste.

COD.	Colore	Gr	Info
40-WCP508	Rossa - Red	5gr	Azo free
40-WCP517	Oro - Gold	5gr	Azo free



CONSIGLI D'USO DIRECTIONS FOR USE

Agitare il flacone prima dell'uso, se utilizzato con penna aerografa nebulizzare a circa 10 cm.

Il prodotto può essere usato per colorare l'interno dello stampo, o direttamente sulla superficie di cioccolato a soggetto finito.

Shake well before use.

When used with the airbrush, keep 10 cm distance from the subject.

It can be used directly on the mould or on the finished subject.

CONSIGLI D'USO DIRECTIONS FOR USE

Agitare il flacone prima dell'uso, se utilizzato con penna aerografa nebulizzare a circa 10 cm.

Il prodotto può essere usato per colorare l'interno dello stampo, o direttamente sulla superficie di cioccolato a soggetto finito.

Shake well before use.

When used with the airbrush, keep 10 cm distance from the subject.

It can be used directly on the mould or on the finished subject.

CONSIGLI D'USO DIRECTIONS FOR USE

Il burro di cacao può essere utilizzato puro per piccole decorazioni con il pennello oppure, se diluito con 50% di cioccolato bianco, può essere spruzzato con pistola a caldo producendo così un effetto vellutato. Spruzzato all'interno di stampi per praline o corpi cavi, sciolto a 30°C oltre a colorare, permette di ottenere un effetto maculato, neve, goccia o buccia d'arancia.

The product when sprayed with hot gun, mixed with 50% of white chocolate, produces a velvety effect. Sprayed into moulds for chocolates, melted at 30°C, in addition to colour, allows to get spotted, snow, drop or orange peel effect.



ACCESSORI PER DOLCI MONUMENTALI ACCESSORIES FOR MONUMENTAL CAKES

Tamburi in plastica bianca **RIUTILIZZABILI IDONEI AL CONTATTO ALIMENTARE.**

Ideali per realizzare wedding cake di grandi dimensioni.

Ogni tamburo è dotato di rinforzo interno dove poter inserire le colonnine necessarie per il montaggio del dolce (40-W101 Ø foro 6 mm). L'articolo è acquistabile in kit oppure è possibile richiedere separatamente ogni singolo tamburo.

White plastic **REUSABLE** cake dummies **SUITABLE FOR FOOD CONTACT.**

Ideal for creating large wedding cakes.

Each cake dummy has internal reinforcement where to insert the columns needed for the assembly of the cake (40-W101 Ø hole 6 mm). The item is purchased as a kit or you can request separately every single cake dummy.

Tamburo singolo Single Dummy

COD. 40-W110

misure-sizes:
Ø20 - h10cm

Tamburo singolo Single Dummy

COD. 40-W111

misure-sizes:
Ø30 - h10cm

Tamburo singolo Single Dummy

COD. 40-W112

misure-sizes:
Ø40 - h10cm

Tamburo singolo Single Dummy

COD. 40-W113

misure-sizes:
Ø50 - h10cm

Struttura completa Set 4 plastic dummies

COD. 40-W106

Struttura completa
4 tamburi in plastica.
Set 4 plastic dummies.

misure-sizes:
Ø50 - h10cm
Ø40 - h10cm
Ø30 - h10cm
Ø20 - h10cm



Supporto per tamburo grande Support for big dummy

COD. 40-W124

misure-sizes:
Ø58cm

Il piatto **facilita il trasporto** della torta evitando spiacevoli cadute.

The plate makes the **transport easier** and reduces the risk of damaging the cake.



Cinture per tamburi Rings for dummies

COD. 40-W087

Cintura per tamburo cod. 40-W110
Ring for dummy cod. 40-W110
misure-sizes: Ø19,5 - h5cm

COD. 40-W089

Cintura per tamburo cod. 40-W112
Ring for dummy cod. 40-W112
misure-sizes: Ø39,5 - h5cm

COD. 40-W088

Cintura per tamburo cod. 40-W111
Ring for dummy cod. 40-W111
misure-sizes: Ø29,5 - h5cm

COD. 40-W090

Cintura per tamburo cod. 40-W113
Ring for dummy cod. 40-W113
misure-sizes: Ø49,5 - h5cm



Colonnine arancioni Orange columns

COD. 40-W101

Pack 50 pcs
Ø6mm
Lunghezza - length 300 mm



Little Wedding Cake

La Wedding Cake è la torta nuziale in stile anglosassone, una vera e propria opera d'arte che attinge dall'esperienza dell'alta pasticceria per esibire decorazioni originali e personalizzate,

dall'aspetto moderno minimalista o acceso e sgargiante. Più passa il tempo e più la torta nuziale assume un ruolo importante all'interno del banchetto gastronomico.

Martellato rivisita un classico proponendo le Little Wedding Cake, porta torta in plastica a tre piani di dimensioni più piccole, adatte quindi a banchetti con un minor numero di invitati, facili da trasportare, misure di ingombro contenute.

The Wedding Cake in Anglo-Saxon style, is a true work of art that drawn on the experience of the haute pâtisserie to show off original and personalized decorations, modern and minimalistic or instead striking and bright. As time goes by, the wedding cake takes on a more important role in banquets.

Martellato revisits a classic offering the Little Wedding Cake, a stand made of plastic with three small levels, therefore suitable for banquets with fewer guests. It is also easy to transport and does not occupy much space.



Rotondo Round cake stand

COD. 201

Rotonda a 3 piani
Round 3 levels
misure-sizes:
Ø 52 - 35 - 18 h 58 cm



Ovale Oval cake stand

COD. 202

Ovale a 3 piani
Oval 3 levels
misure-sizes:
51x43 - 36x26 - 20x10 h 58 cm



Rettangolare Rectangular

COD. 203

Rettangolare a 3 piani
Rectangular 3 levels
misure-sizes:
51x43 - 36x26 - 20x10 h 58 cm



Quadrata Square cake stand

COD. 204

Quadrata a 3 piani
Square 3 levels
misure-sizes:
49x49 - 34x34 - 18x18 h58 cm



FORME INOX

Acciaio lucido Spessore 1,2 mm.

ST. STEEL BANDS

Polished st. steel. Thickness 1,2 mm.

Cinture Ovali Oval Rings

COD. 2H4X10	40 mm	115x85 mm
COD. 2H4X12	40 mm	135x100 mm
COD. 2H4X14	40 mm	160x120 mm
COD. 2H4X16	40 mm	185x135 mm
COD. 2H4X18	40 mm	205x155 mm
COD. 2H4X20	40 mm	225x175 mm
COD. 2H4X22	40 mm	253x190 mm
COD. 2H4X24	40 mm	270x210 mm
COD. 2H4X26	40 mm	300x220 mm
COD. 2H4X28	40 mm	320x250 mm
COD. 2H4X30	40 mm	345x260 mm
COD. 2H5X10	50 mm	115x85 mm
COD. 2H5X12	50 mm	135x100 mm
COD. 2H5X14	50 mm	160x120 mm
COD. 2H5X16	50 mm	185x135 mm
COD. 2H5X18	50 mm	205x155 mm
COD. 2H5X20	50 mm	235x165 mm
COD. 2H5X22	50 mm	253x190 mm
COD. 2H5X24	50 mm	275x200 mm
COD. 2H5X26	50 mm	300x220 mm
COD. 2H5X28	50 mm	315x250 mm
COD. 2H5X30	50 mm	335x270 mm

Cinture Quadrate Square Rings

COD. 5H4X10	40 mm	lato 10 cm
COD. 5H4X12	40 mm	lato 12 cm
COD. 5H4X14	40 mm	lato 14 cm
COD. 5H4X16	40 mm	lato 16 cm
COD. 5H4X18	40 mm	lato 18 cm
COD. 5H4X20	40 mm	lato 20 cm
COD. 5H4X22	40 mm	lato 22 cm
COD. 5H4X24	40 mm	lato 24 cm
COD. 5H4X26	40 mm	lato 26 cm
COD. 5H4X28	40 mm	lato 28 cm
COD. 5H4X30	40 mm	lato 30 cm
COD. 5H5X10	50 mm	lato 10 cm
COD. 5H5X12	50 mm	lato 12 cm
COD. 5H5X14	50 mm	lato 14 cm
COD. 5H5X16	50 mm	lato 16 cm
COD. 5H5X18	50 mm	lato 18 cm
COD. 5H5X20	50 mm	lato 20 cm
COD. 5H5X22	50 mm	lato 22 cm
COD. 5H5X24	50 mm	lato 24 cm
COD. 5H5X26	50 mm	lato 26 cm
COD. 5H5X28	50 mm	lato 28 cm
COD. 5H5X30	50 mm	lato 30 cm

Cinture Tonde Round Rings

COD. 1H2X10	20 mm	Ø 100 mm
COD. 1H2X12	20 mm	Ø 120 mm
COD. 1H2X14	20 mm	Ø 140 mm
COD. 1H2X16	20 mm	Ø 160 mm
COD. 1H2X18	20 mm	Ø 180 mm
COD. 1H2X20	20 mm	Ø 200 mm
COD. 1H2X22	20 mm	Ø 220 mm
COD. 1H2X24	20 mm	Ø 240 mm
COD. 1H2X26	20 mm	Ø 260 mm
COD. 1H2X28	20 mm	Ø 280 mm
COD. 1H2X30	20 mm	Ø 300 mm
COD. 1H4X10	40 mm	Ø 100 mm
COD. 1H5X10	50 mm	Ø 100 mm
COD. 1H4X12	40 mm	Ø 120 mm
COD. 1H5X12	50 mm	Ø 120 mm
COD. 1H4X14	40 mm	Ø 140 mm
COD. 1H5X14	50 mm	Ø 140 mm
COD. 1H4X16	40 mm	Ø 160 mm
COD. 1H5X16	50 mm	Ø 160 mm
COD. 1H4X18	40 mm	Ø 180 mm
COD. 1H5X18	50 mm	Ø 180 mm
COD. 1H4X20	40 mm	Ø 200 mm

COD. 1H5X20	50 mm	Ø 200 mm
COD. 1H4X22	40 mm	Ø 220 mm
COD. 1H5X22	50 mm	Ø 220 mm
COD. 1H4X24	40 mm	Ø 240 mm
COD. 1H5X24	50 mm	Ø 240 mm
COD. 1H4X26	40 mm	Ø 260 mm
COD. 1H5X26	50 mm	Ø 260 mm
COD. 1H4X28	40 mm	Ø 280 mm
COD. 1H5X28	50 mm	Ø 280 mm
COD. 1H4X30	40 mm	Ø 300 mm
COD. 1H5X30	50 mm	Ø 300 mm

Altre forme disponibili
nel catalogo generale
Martellato
Other shapes available in
the general catalogue



8 dischi sottotorta Set 8 round trays

COD. SETDISK



Rettangolari Rectangular

COD. 40-W066	23x33 cm	conf. 20 pz
COD. 40-W067	25x35 cm	conf. 20 pz
COD. 40-W068	28x38 cm	conf. 20 pz
COD. 40-W069	30x40 cm	conf. 20 pz
COD. 40-W070	32x48 cm	conf. 20 pz
COD. 40-W071	34x50 cm	conf. 20 pz

Tondi Round

COD. 40-W056	Ø 16 cm	conf. 20 pz
COD. 40-W057	Ø 18 cm	conf. 20 pz
COD. 40-W058	Ø 20 cm	conf. 20 pz
COD. 40-W059	Ø 22 cm	conf. 20 pz
COD. 40-W060	Ø 24 cm	conf. 20 pz
COD. 40-W061	Ø 26 cm	conf. 20 pz
COD. 40-W062	Ø 28 cm	conf. 20 pz
COD. 40-W063	Ø 30 cm	conf. 20 pz
COD. 40-W064	Ø 32 cm	conf. 20 pz
COD. 40-W208	Ø 34 cm	conf. 20 pz
COD. 40-W209	Ø 36 cm	conf. 20 pz
COD. 40-W210	Ø 38 cm	conf. 20 pz
COD. 40-W065	Ø 40 cm	conf. 20 pz

Quadrati Square

COD. 40-W072	18x18 cm	conf. 20 pz
COD. 40-W073	20x20 cm	conf. 20 pz
COD. 40-W074	23x23 cm	conf. 20 pz
COD. 40-W075	25x25 cm	conf. 20 pz
COD. 40-W076	28x28 cm	conf. 20 pz
COD. 40-W077	30x30 cm	conf. 20 pz
COD. 40-W078	33x33 cm	conf. 20 pz
COD. 40-W079	35x35 cm	conf. 20 pz
COD. 40-W080	38x38 cm	conf. 20 pz
COD. 40-W081	40x40 cm	conf. 20 pz

ALZATINE - PLEXIGLASS CAKE STANDS

Piatto - Plate: Ø210mm



Nero - Black

COD. 80-0108 h 103 mm
COD. 80-0208 h 163 mm
COD. 80-0308 h 223 mm



Grigio - Gray

COD. 80-1010 h 103 mm
COD. 80-1110 h 163 mm
COD. 80-1210 h 223 mm

Satinato - Glazed

COD. 80-0106 h 103 mm
COD. 80-0206 h 163 mm
COD. 80-0306 h 223 mm

Satinato - Glazed

COD. 80-1006 h 103 mm
COD. 80-1106 h 163 mm
COD. 80-1206 h 223 mm



Fucsia - Fuchsia

COD. 80-0409 h 103 mm
COD. 80-0509 h 163 mm
COD. 80-0609 h 223 mm



Arancione - Orange

COD. 80-0703 h 103 mm
COD. 80-0803 h 163 mm
COD. 80-0903 h 223 mm

Satinato - Glazed

COD. 80-0406 h 103 mm
COD. 80-0506 h 163 mm
COD. 80-0606 h 223 mm

Satinato - Glazed

COD. 80-0706 h 103 mm
COD. 80-0806 h 163 mm
COD. 80-0906 h 223 mm

PIROTTINI IN PLASTICA - PLASTIC CUPS



Ø65x h36 mm - Cap. 70 gr
COD. 60P00100
 Pack 100 pcs
COD. 60P00100/12
 Pack 12 pcs

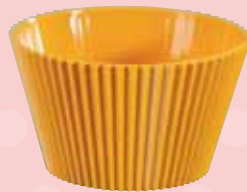

Ø65x h36 mm - Cap. 70 gr
COD. 60P00111
 Pack 100 pcs
COD. 60P00111/12
 Pack 12 pcs



Ø65x h36 mm - Cap. 70 gr
COD. 60P00109
 Pack 100 pcs
COD. 60P00109/12
 Pack 12 pcs



Ø65x h36 mm - Cap. 70 gr
COD. 60P00102
 Pack 100 pcs
COD. 60P00102/12
 Pack 12 pcs

Ø76x h43 mm - Cap. 120 gr
COD. 60P00200
 Pack 100 pcs
COD. 60P00200/12
 Pack 12 pcs

Ø76x h43 mm - Cap. 120 gr
COD. 60P00211
 Pack 100 pcs
COD. 60P00211/12
 Pack 12 pcs

Ø76x h43 mm - Cap. 120 gr
COD. 60P00209
 Pack 100 pcs
COD. 60P00209/12
 Pack 12 pcs

Ø76x h43 mm - Cap. 120 gr
COD. 60P00202
 Pack 100 pcs
COD. 60P00202/12
 Pack 12 pcs



Ø65x h36 mm - Cap. 70 gr
COD. 60P00107
 Pack 100 pcs
COD. 60P00107/12
 Pack 12 pcs



Ø65x h36 mm - Cap. 70 gr
COD. 60P00121
 Pack 100 pcs
COD. 60P00121/12
 Pack 12 pcs



Ø65x h36 mm - Cap. 70 gr
COD. 60P00108
 Pack 100 pcs
COD. 60P00108/12
 Pack 12 pcs

Ø76x h43 mm - Cap. 120 gr
COD. 60P00207
 Pack 100 pcs
COD. 60P00207/12
 Pack 12 pcs

Ø76x h43 mm - Cap. 120 gr
COD. 60P00221
 Pack 100 pcs
COD. 60P00221/12
 Pack 12 pcs

Ø76x h43 mm - Cap. 120 gr
COD. 60P00208
 Pack 100 pcs
COD. 60P00208/12
 Pack 12 pcs



Plastica non idonea alla cottura
 Plastic not suitable for baking

INDICE ARTICOLI IN ORDINE ALFABETICO

ITEMS INDEX IN ALPHABETICAL ORDER

001OAL	Pg. 57	1H5X26	Pg. 74	40-W017S	Pg. 20	40-W073	Pg. 74
002OCD	Pg. 57	1H5X28	Pg. 74	40-W018S	Pg. 17	40-W074	Pg. 74
002OCL	Pg. 57	1H5X30	Pg. 74	40-W021	Pg. 55	40-W075	Pg. 74
003VAD	Pg. 57	2H4X10	Pg. 74	40-W022	Pg. 55	40-W076	Pg. 74
003VAL	Pg. 57	2H4X12	Pg. 74	40-W026	Pg. 56	40-W077	Pg. 74
004VCD	Pg. 57	2H4X14	Pg. 74	40-W027	Pg. 15	40-W078	Pg. 74
004VCL	Pg. 57	2H4X16	Pg. 74	40-W028	Pg. 11	40-W079	Pg. 74
005CAD	Pg. 57	2H4X18	Pg. 74	40-W029	Pg. 12	40-W080	Pg. 74
005CAL	Pg. 57	2H4X20	Pg. 74	40-W030	Pg. 13	40-W081	Pg. 74
006CCD	Pg. 57	2H4X22	Pg. 74	40-W031	Pg. 55	40-W082	Pg. 15
006CCL	Pg. 57	2H4X24	Pg. 74	40-W032	Pg. 60	40-W083	Pg. 52
007LDD	Pg. 57	2H4X26	Pg. 74	40-W033	Pg. 60	40-W084	Pg. 52
007LDL	Pg. 57	2H4X28	Pg. 74	40-W034	Pg. 60	40-W085	Pg. 52
008CUD	Pg. 57	2H4X30	Pg. 74	40-W035	Pg. 60	40-W086	Pg. 52
008CUL	Pg. 57	2H5X10	Pg. 74	40-W036	Pg. 60	40-W087	Pg. 73
009AGD	Pg. 57	2H5X12	Pg. 74	40-W037	Pg. 60	40-W088	Pg. 73
009AGL	Pg. 57	2H5X14	Pg. 74	40-W038	Pg. 60	40-W089	Pg. 73
010LOD	Pg. 57	2H5X16	Pg. 74	40-W039	Pg. 14	40-W090	Pg. 73
010LOL	Pg. 57	2H5X18	Pg. 74	40-W040	Pg. 14	40-W091S	Pg. 17
1H2X10	Pg. 74	2H5X20	Pg. 74	40-W041	Pg. 14	40-W092	Pg. 34
1H2X12	Pg. 74	2H5X22	Pg. 74	40-W042	Pg. 66	40-W093	Pg. 34
1H2X14	Pg. 74	2H5X24	Pg. 74	40-W043S	Pg. 17	40-W094	Pg. 34
1H2X16	Pg. 74	2H5X26	Pg. 74	40-W044	Pg. 13	40-W095	Pg. 34
1H2X18	Pg. 74	2H5X28	Pg. 74	40-W045	Pg. 13	40-W096	Pg. 34
1H2X20	Pg. 74	2H5X30	Pg. 74	40-W046	Pg. 14	40-W097	Pg. 34
1H2X22	Pg. 74	40-0015	Pg. 11	40-W049S	Pg. 4	40-W098	Pg. 34
1H2X24	Pg. 74	40-0016	Pg. 11	40-W050S	Pg. 20	40-W099	Pg. 34
1H2X26	Pg. 74	40-0102	Pg. 12	40-W051S	Pg. 4	40-W100	Pg. 34
1H2X28	Pg. 74	40-0304	Pg. 10	40-W052	Pg. 56	40-W101	Pg. 73
1H2X30	Pg. 74	40-0506	Pg. 10	40-W053	Pg. 15	40-W106	Pg. 72
1H4X10	Pg. 74	40-0708	Pg. 11	40-W054	Pg. 15	40-W108	Pg. 56
1H4X12	Pg. 74	40-0910	Pg. 11	40-W055	Pg. 15	40-W109	Pg. 51
1H4X14	Pg. 74	40-1112	Pg. 10	40-W056	Pg. 74	40-W110	Pg. 72
1H4X16	Pg. 74	40-1314	Pg. 10	40-W057	Pg. 74	40-W111	Pg. 72
1H4X18	Pg. 74	40-W001	Pg. 11	40-W058	Pg. 74	40-W112	Pg. 72
1H4X20	Pg. 74	40-W002	Pg. 12	40-W059	Pg. 74	40-W113	Pg. 72
1H4X22	Pg. 74	40-W003	Pg. 10	40-W060	Pg. 74	40-W114	Pg. 14
1H4X24	Pg. 74	40-W004	Pg. 55	40-W061	Pg. 74	40-W115	Pg. 14
1H4X26	Pg. 74	40-W005	Pg. 12	40-W062	Pg. 74	40-W116	Pg. 14
1H4X28	Pg. 74	40-W006	Pg. 13	40-W063	Pg. 74	40-W118	Pg. 14
1H4X30	Pg. 74	40-W007	Pg. 10	40-W064	Pg. 74	40-W120	Pg. 14
1H5X10	Pg. 74	40-W008	Pg. 12	40-W065	Pg. 74	40-W121	Pg. 14
1H5X12	Pg. 74	40-W009	Pg. 13	40-W066	Pg. 74	40-W122	Pg. 14
1H5X14	Pg. 74	40-W010S	Pg. 17	40-W067	Pg. 74	40-W123	Pg. 14
1H5X16	Pg. 74	40-W011S	Pg. 20	40-W068	Pg. 74	40-W124	Pg. 72
1H5X18	Pg. 74	40-W013S	Pg. 17	40-W069	Pg. 74	40-W125	Pg. 61
1H5X20	Pg. 74	40-W014S	Pg. 18	40-W070	Pg. 74	40-W126	Pg. 52
1H5X22	Pg. 74	40-W015S	Pg. 18	40-W071	Pg. 74	40-W127	Pg. 52
1H5X24	Pg. 74	40-W016S	Pg. 20	40-W072	Pg. 74	40-W128	Pg. 52

40-W129 Pg. 52
40-W130 Pg. 52
40-W131 Pg. 52
40-W132 Pg. 52
40-W133 Pg. 52
40-W134 Pg. 52
40-W135 Pg. 52
40-W137 Pg. 60
40-W138 Pg. 60
40-W139 Pg. 55
40-W140 Pg. 20
40-W141 Pg. 54
40-W142 Pg. 52
40-W143 Pg. 52
40-W144 Pg. 52
40-W145 Pg. 52
40-W146 Pg. 52
40-W147 Pg. 52
40-W148 Pg. 52
40-W149 Pg. 52
40-W150 Pg. 52
40-W151 Pg. 52
40-W152 Pg. 52
40-W153 Pg. 52
40-W154 Pg. 55
40-W155S Pg. 17
40-W156S Pg. 16
40-W157S Pg. 17
40-W158S Pg. 18
40-W159S Pg. 19
40-W160S Pg. 18
40-W161S Pg. 18
40-W162S Pg. 18
40-W163S Pg. 18
40-W164A Pg. 55
40-W165A Pg. 55
40-W166 Pg. 66
40-W167 Pg. 54
40-W168 Pg. 32
40-W169 Pg. 32
40-W170 Pg. 32
40-W171 Pg. 32
40-W172 Pg. 32
40-W173 Pg. 32
40-W174 Pg. 35
40-W175 Pg. 35
40-W176 Pg. 35
40-W177 Pg. 35
40-W178 Pg. 35
40-W179 Pg. 35
40-W180 Pg. 35
40-W181 Pg. 35
40-W182 Pg. 35
40-W183 Pg. 35
40-W184 Pg. 35

40-W185 Pg. 35
40-W186 Pg. 35
40-W187 Pg. 35
40-W188S Pg. 8
40-W189 Pg. 15
40-W192C Pg. 15
40-W192S Pg. 3
40-W193C Pg. 15
40-W193S Pg. 5
40-W194B Pg. 15
40-W194C Pg. 15
40-W194C1 Pg. 15
40-W194S Pg. 2
40-W195S Pg. 19
40-W196S Pg. 19
40-W197S Pg. 19
40-W198V Pg. 56
40-W199V Pg. 60
40-W200 Pg. 61
40-W20045 Pg. 61
40-W201S Pg. 16
40-W202S Pg. 16
40-W203S Pg. 16
40-W204C Pg. 15
40-W204K Pg. 6
40-W204S Pg. 6
40-W205S Pg. 6
40-W206C Pg. 15
40-W206C1 Pg. 15
40-W206S Pg. 2
40-W207S Pg. 7
40-W208 Pg. 74
40-W209 Pg. 74
40-W210 Pg. 74
40-W211S Pg. 16
40-W300 Pg. 21
40-W300C Pg. 21
40-W300C1 Pg. 21
40-WA001V Pg. 58
40-WA002 Pg. 59
40-WA003 Pg. 59
40-WA004V Pg. 53
40-WA005V Pg. 53
40-WA006V Pg. 56
40-WA007 Pg. 58
40-WA008 Pg. 59
40-WA009 Pg. 59
40-WA010 Pg. 65
40-WB001 Pg. 12
40-WB100 Pg. 24
40-WB101 Pg. 23
40-WB102 Pg. 22
40-WB103 Pg. 23
40-WB104 Pg. 24
40-WB105 Pg. 24

40-WB106 Pg. 23
40-WB107 Pg. 25
40-WB108 Pg. 25
40-WB109 Pg. 25
40-WC015 Pg. 68
40-WC017 Pg. 68
40-WC020 Pg. 68
40-WC100 Pg. 67
40-WC119 Pg. 68
40-WC300 Pg. 68
40-WC302 Pg. 68
40-WC304 Pg. 68
40-WC305 Pg. 68
40-WC306 Pg. 68
40-WC307 Pg. 68
40-WC308 Pg. 68
40-WC309 Pg. 68
40-WC310 Pg. 68
40-WC311 Pg. 68
40-WC322 Pg. 68
40-WC600 Pg. 70
40-WC601 Pg. 70
40-WC602 Pg. 70
40-WC603 Pg. 70
40-WC604 Pg. 70
40-WC605 Pg. 70
40-WC606 Pg. 70
40-WC607 Pg. 70
40-WC608 Pg. 70
40-WC609 Pg. 70
40-WC610 Pg. 70
40-WC611 Pg. 70
40-WC612 Pg. 70
40-WC617 Pg. 70
40-WC619 Pg. 70
40-WCA301 Pg. 71
40-WCA303 Pg. 71
40-WCA304 Pg. 71
40-WCA306 Pg. 71
40-WCA308 Pg. 71
40-WCA326 Pg. 71
40-WCA417 Pg. 71
40-WCA419 Pg. 71
40-WCB200 Pg. 71
40-WCB201 Pg. 71
40-WCB202 Pg. 71
40-WCB204 Pg. 71
40-WCB206 Pg. 71
40-WCB208 Pg. 71
40-WCB210 Pg. 71
40-WCB217 Pg. 71
40-WCP508 Pg. 71
40-WCP517 Pg. 71
40-WD001 Pg. 28
40-WD001T Pg. 28

40-WD002 Pg. 28
40-WD002T Pg. 28
40-WD003 Pg. 29
40-WD003T Pg. 29
40-WD004 Pg. 29
40-WD004T Pg. 29
40-WD005 Pg. 28
40-WD005T Pg. 28
40-WD006 Pg. 29
40-WD007 Pg. 29
40-WD007T Pg. 29
40-WD008 Pg. 30
40-WD008T Pg. 30
40-WD009 Pg. 28
40-WD009T Pg. 28
40-WD010 Pg. 31
40-WD010T Pg. 31
40-WD011 Pg. 31
40-WD011T Pg. 31
40-WD012 Pg. 31
40-WD012T Pg. 31
40-WD013 Pg. 26
40-WD013T Pg. 26
40-WD014 Pg. 31
40-WD014T Pg. 31
40-WD015 Pg. 26
40-WD015T Pg. 26
40-WD016 Pg. 26
40-WD016T Pg. 26
40-WD017 Pg. 31
40-WD017T Pg. 31
40-WF001 Pg. 9
40-WF002 Pg. 9
40-WF003 Pg. 9
40-WF004 Pg. 9
40-WF005 Pg. 9
40-WF006 Pg. 9
40-WF007 Pg. 9
40-WF008 Pg. 9
40-WF009 Pg. 9
40-WF010 Pg. 9
40-WF011 Pg. 9
40-WF012 Pg. 9
40-WM001 Pg. 39
40-WM002 Pg. 45
40-WM003 Pg. 40
40-WM004 Pg. 40
40-WM005 Pg. 40
40-WM006 Pg. 40
40-WM007 Pg. 40
40-WM008 Pg. 41
40-WM009 Pg. 40
40-WM010 Pg. 39
40-WM011 Pg. 41
40-WM012 Pg. 41

40-WM013	Pg. 41
40-WM014	Pg. 41
40-WM015	Pg. 39
40-WM016	Pg. 39
40-WM017	Pg. 39
40-WM018	Pg. 45
40-WM019	Pg. 44
40-WM020	Pg. 44
40-WM021	Pg. 44
40-WM022	Pg. 44
40-WM023	Pg. 45
40-WM024	Pg. 40
40-WM025	Pg. 38
40-WM026	Pg. 37
40-WM027	Pg. 37
40-WM028	Pg. 37
40-WM029	Pg. 37
40-WM030	Pg. 37
40-WM031	Pg. 37
40-WM032	Pg. 37
40-WM033	Pg. 37
40-WM034	Pg. 40
40-WM035	Pg. 37
40-WM036	Pg. 43
40-WM037	Pg. 43
40-WM038	Pg. 43
40-WM039	Pg. 43
40-WM040	Pg. 42
40-WM041	Pg. 42
40-WM042	Pg. 36
40-WM043	Pg. 38
40-WM044	Pg. 38
40-WM045	Pg. 38
40-WM046	Pg. 48
40-WM047	Pg. 39
40-WM048	Pg. 45
40-WM500	Pg. 46
40-WM501	Pg. 47
40-WM502	Pg. 46
40-WM503	Pg. 47
40-WM504	Pg. 47
40-WM505	Pg. 47
40-WM506	Pg. 36
40-WM507	Pg. 38
40-WM508	Pg. 39
40-WM509	Pg. 48
40-WR001	Pg. 48
40-WR002	Pg. 49
40-WR003	Pg. 49
40-WR004	Pg. 49
40-WR005	Pg. 49
40-WSR001	Pg. 32
40-WSR002	Pg. 33
40-WSR003	Pg. 32
40-WSR004	Pg. 33

40-WSR005	Pg. 33
40-WSR006	Pg. 33
40-WSR007	Pg. 33
40-WSR008	Pg. 33
40-WSR009	Pg. 33
40-WSR010	Pg. 33
40-WSR011	Pg. 33
40-WSR012	Pg. 33
40-WSR013	Pg. 33
40-WSR014	Pg. 33
40-WSR015	Pg. 32
40-WSR016	Pg. 32
40-WSR017	Pg. 33
40-WSR018	Pg. 32
40-WSR019	Pg. 32
40-WST001	Pg. 35
40-WST002	Pg. 35
40-WST003	Pg. 35
40-WST004	Pg. 35
40-WST005	Pg. 35
40-WST006	Pg. 35
40-WST007	Pg. 35
40-WST008	Pg. 35
40-WST009	Pg. 35
40-WST010	Pg. 35
40-WST011	Pg. 35
40-WST012	Pg. 35
40-WST013	Pg. 35
40-WST014	Pg. 35
40-WST501	Pg. 35
40-WST502	Pg. 35
40-WST503	Pg. 35
40-WST504	Pg. 35
40-WST505	Pg. 35
40-WST506	Pg. 35
40-WST507	Pg. 35
40-WST508	Pg. 35
40-WST509	Pg. 35
40-WST510	Pg. 35
40-WST511	Pg. 35
40-WST512	Pg. 35
40-WST513	Pg. 35
40-WST514	Pg. 35
40SQ001	Pg. 30
40SQ001T	Pg. 30
50WA004B	Pg. 53
50WA005B	Pg. 53
50WA006B	Pg. 56
5H4X10	Pg. 74
5H4X12	Pg. 74
5H4X14	Pg. 74
5H4X16	Pg. 74
5H4X18	Pg. 74
5H4X20	Pg. 74
5H4X22	Pg. 74

5H4X24	Pg. 74
5H4X26	Pg. 74
5H4X28	Pg. 74
5H4X30	Pg. 74
5H5X10	Pg. 74
5H5X12	Pg. 74
5H5X14	Pg. 74
5H5X16	Pg. 74
5H5X18	Pg. 74
5H5X20	Pg. 74
5H5X22	Pg. 74
5H5X24	Pg. 74
5H5X26	Pg. 74
5H5X28	Pg. 74
5H5X30	Pg. 74
60P00100	Pg. 75
60P00100/12	Pg. 75
60P00102	Pg. 75
60P00102/12	Pg. 75
60P00107	Pg. 75
60P00107/12	Pg. 75
60P00108	Pg. 75
60P00108/12	Pg. 75
60P00109	Pg. 75
60P00109/12	Pg. 75
60P00111	Pg. 75
60P00111/12	Pg. 75
60P00121	Pg. 75
60P00121/12	Pg. 75
60P00200	Pg. 75
60P00200/12	Pg. 75
60P00202	Pg. 75
60P00202/12	Pg. 75
60P00207	Pg. 75
60P00207/12	Pg. 75
60P00208	Pg. 75
60P00208/12	Pg. 75
60P00209	Pg. 75
60P00209/12	Pg. 75
60P00211	Pg. 75
60P00211/12	Pg. 75
60P00221	Pg. 75
60P00221/12	Pg. 75
80-0106	Pg. 75
80-0108	Pg. 75
80-0206	Pg. 75
80-0208	Pg. 75
80-0306	Pg. 75
80-0308	Pg. 75
80-0406	Pg. 75
80-0409	Pg. 75
80-0506	Pg. 75
80-0509	Pg. 75
80-0606	Pg. 75
80-0609	Pg. 75

80-0703	Pg. 75
80-0706	Pg. 75
80-0803	Pg. 75
80-0806	Pg. 75
80-0903	Pg. 75
80-0906	Pg. 75
80-1006	Pg. 75
80-1010	Pg. 75
80-1106	Pg. 75
80-1110	Pg. 75
80-1206	Pg. 75
80-1210	Pg. 75
BX0001	Pg. 63
BX0002	Pg. 63
BX0004	Pg. 63
BX0005	Pg. 63
BX0006	Pg. 63
BX0008	Pg. 63
BX0009	Pg. 63
BX0011	Pg. 63
BX0012	Pg. 63
BX0014	Pg. 63
BX0016	Pg. 63
BX0017	Pg. 63
BX0023	Pg. 63
BX0024	Pg. 63
BX0025	Pg. 63
BX0026	Pg. 62
BX0026	Pg. 63
BX0027	Pg. 62
BX0028	Pg. 62
BX0029	Pg. 62
BX0030	Pg. 62
BX0031	Pg. 62
BX0032	Pg. 62
BX0033	Pg. 62
BX0034	Pg. 62
BX0035	Pg. 62
BX0036	Pg. 62
BX0037	Pg. 62
BX0038	Pg. 62
BX0039	Pg. 62
BX0040	Pg. 62
BX0041	Pg. 62
BX0042	Pg. 62
BX0043	Pg. 62
BX0044	Pg. 62
BX0045	Pg. 62
BX0046	Pg. 62
BX0047	Pg. 62
BX0048	Pg. 62
BX0049	Pg. 62
BX0050	Pg. 62
BX0051	Pg. 63
BX0052	Pg. 63

BX0053	Pg. 63
BX0054	Pg. 63
BX0055	Pg. 63
BX0056	Pg. 63
BX0057	Pg. 63
BX0058	Pg. 63
BX0059	Pg. 63
BX0060	Pg. 63
BX0061	Pg. 63
BX0100	Pg. 64
BX0101	Pg. 64
BX0102	Pg. 64
BX0103	Pg. 64
BX0104	Pg. 64
BXB01	Pg. 64
BXB02	Pg. 64
COATING	Pg. 69
COD.201	Pg. 73
COD.202	Pg. 73
COD.203	Pg. 73
COD.204	Pg. 73
DECOAIR2	Pg. 50
DECOAIR3	Pg. 50
DECOCP01	Pg. 51
DECOF01	Pg. 50
DECOH01	Pg. 50
DECOMP7	Pg. 50
DECOMP8	Pg. 50
EFF000	Pg. 66
EFF001	Pg. 66
EFSD001	Pg. 67
EFSD002	Pg. 67
EFSD006	Pg. 67
EFSP002	Pg. 67
EFSP007	Pg. 67
EFSP008	Pg. 67
EFSP010	Pg. 67
EFSP017	Pg. 67
EFSP019	Pg. 67
EFSP025	Pg. 67
EFT02	Pg. 14
EFT04	Pg. 14
EFT05	Pg. 14
EFT07	Pg. 14
EFT10	Pg. 14
EFT11	Pg. 14
EFT12	Pg. 14
EFT13	Pg. 14
ESPOB032	Pg. 65
ESPOB60	Pg. 65
EUROCHOCK	Pg. 69
GIRA	Pg. 61
GIRA2	Pg. 61
GIRA3	Pg. 61
LCA000	Pg. 70

LCA001	Pg. 70
LCA002	Pg. 70
LCA003	Pg. 70
LCA004	Pg. 70
LCA005	Pg. 70
LCA006	Pg. 70
LCA007N	Pg. 70
LCA008N	Pg. 70
LCA009	Pg. 70
LCA010	Pg. 70
LCA011	Pg. 70
LCA012	Pg. 70
LCA201	Pg. 70
LCA203	Pg. 70
LCA205	Pg. 70
LCA206	Pg. 70
LCA207N	Pg. 70
LCA208N	Pg. 70
LCA209	Pg. 70
LCA210	Pg. 70
LCA211	Pg. 70
LCA212	Pg. 70
LCA217	Pg. 70
LCA219	Pg. 70
LCA300	Pg. 71
LCA303	Pg. 71
LCA304	Pg. 71
LCA307	Pg. 71
LCA308	Pg. 71
LCA309	Pg. 71
LCA408	Pg. 71
LCA417	Pg. 71
LCA419	Pg. 71
LCAS100	Pg. 69
LCB200	Pg. 71
LCB201	Pg. 71
LCB202	Pg. 71
LCB204	Pg. 71
LCB206	Pg. 71
LCB208	Pg. 71
LCB209	Pg. 71
LCB210	Pg. 71
LCG001	Pg. 66
LCG002	Pg. 66
LCG004	Pg. 66
LCG005	Pg. 66
LCG006	Pg. 66
LCG007	Pg. 66
LCG008	Pg. 66
LCG009	Pg. 66
LCG010	Pg. 66
LCG022	Pg. 66
LCG025	Pg. 66
LCJ000	Pg. 67
LCJ100	Pg. 67

LCP003	Pg. 68
LCP008	Pg. 68
LCP009	Pg. 68
LCP010	Pg. 68
LCP015	Pg. 68
LCP017N	Pg. 68
LCP018	Pg. 68
LCP019N	Pg. 68
LCP020	Pg. 68
LCP021	Pg. 68
LCP117	Pg. 68
LCP119	Pg. 68
LCP202	Pg. 68
LCP204	Pg. 68
LCP206	Pg. 68
LCP208	Pg. 68
LCP209	Pg. 68
LCP211	Pg. 68
LCP218	Pg. 68
LCP300	Pg. 68
LCP302	Pg. 68
LCP304	Pg. 68
LCP305	Pg. 68
LCP306	Pg. 68
LCP307	Pg. 68
LCP308	Pg. 68
LCP308N	Pg. 68
LCP309	Pg. 68
LCP311	Pg. 68
LCS001	Pg. 69
LCS003	Pg. 69
LCS004	Pg. 69
LCS005	Pg. 69
LCS007	Pg. 69
LCS008	Pg. 69
LCS009	Pg. 69
LCS200	Pg. 69
LCS215	Pg. 69
LCS217N	Pg. 69
LCS218N	Pg. 69
LCS219N	Pg. 69
LCS220	Pg. 69
LCV000	Pg. 70
LCV001	Pg. 70
LCV003	Pg. 70
LCV004	Pg. 70
LCV005N	Pg. 70
LCV008	Pg. 70
LCV009N	Pg. 70
LCV015N	Pg. 70
LCV100	Pg. 69
LCV107	Pg. 70
RTKIT	Pg. 55
SETDISK	Pg. 74



Алматы (7273)495-231
Ангарск (3955)60-70-56
Архангельск (8182)63-90-72
Астрахань (8512)99-46-04
Барнаул (3852)73-04-60
Белгород (4722)40-23-64
Благовещенск (4162)22-76-07
Брянск (4832)59-03-52
Владивосток (423)249-28-31
Владикавказ (8672)28-90-48
Владимир (4922) 49-43-18
Волгоград (844)278-03-48
Вологда (8172)26-41-59
Воронеж (473)204-51-73
Екатеринбург (343)384-55-89

Ижевск (3412)26-03-58
Иваново (4932)77-34-06
Иркутск (395)279-98-46
Казань (843)206-01-48
Калининград (4012)72-03-81
Калуга (4842)92-23-67
Кемерово (3842)65-04-62
Киров (8332)68-02-04
Коломна (4966)23-41-49
Кострома (4942)77-07-48
Краснодар (861)203-40-90
Красноярск (391)204-63-61
Курск (4712)77-13-04
Курган (3522)50-90-47
Липецк (4742)52-20-81

Магнитогорск (3519)55-03-13
Москва (495)268-04-70
Мурманск (8152)59-64-93
Набережные Челны (8552)20-53-41
Нижний Новгород (831)429-08-12
Новокузнецк (3843)20-46-81
Ноябрьск (3496)41-32-12
Новосибирск (383)227-86-73
Ноябрьск (3496)41-32-12
Омск (3812)21-46-40
Орел (4862)44-53-42
Оренбург (3532)37-68-04
Пенза (8412)22-31-16
Петрозаводск (8142)55-98-37
Псков (8112)59-10-37

Пермь (342)205-81-47
Ростов-на-Дону (863)308-18-15
Рязань (4912)46-61-64
Самара (846)206-03-16
Саранск (8342)22-96-24
Санкт-Петербург (812)309-46-40
Саратов (845)249-38-78
Севастополь (8692)22-31-93
Симферополь (3652)67-13-56
Смоленск (4812)29-41-54
Сочи (862)225-72-31
Ставрополь (8652)20-65-13
Сыктывкар (8212)25-95-17
Сургут (3462)77-98-35
Тамбов (4752)50-40-97

Тверь (4822)63-31-35
Тольяти (8482)63-91-07
Томск (3822)98-41-53
Тула (4872)33-79-87
Тюмень (3452)66-21-18
Улан-Удэ (3012)59-97-51
Ульяновск (8422)24-23-59
Уфа (347)229-48-12
Хабаровск (4212)92-98-04
Чебоксары (8352)28-53-07
Челябинск (351)202-03-61
Череповец (8202)49-02-64
Чита (3022)38-34-83
Якутск (4112)23-90-97
Ярославль (4852)69-52-93

Киргизия (996)312-96-26-47

Россия (495)268-04-70

Казахстан (772)734-952-31

<https://martellato.nt-rt.ru> || mot@nt-rt.ru