

Алматы (7273)495-231
Ангарск (3955)60-70-56
Архангельск (8182)63-90-72
Астрахань (8512)99-46-04
Барнаул (3852)73-04-60
Белгород (4722)40-23-64
Благовещенск (4162)22-76-07
Брянск (4832)59-03-52
Владивосток (423)249-28-31
Владикавказ (8672)28-90-48
Владимир (4922) 49-43-18
Волгоград (844)278-03-48
Волгодга (8172)26-41-59
Воронеж (473)204-51-73
Екатеринбург (343)384-55-89

Ижевск (3412)26-03-58
Иваново (4932)77-34-06
Иркутск (395)279-98-46
Казань (843)206-01-48
Калининград (4012)72-03-81
Калуга (4842)92-23-67
Кемерово (3842)65-04-62
Киров (8332)68-02-04
Коломна (4966)23-41-49
Кострома (4942)77-07-48
Краснодар (861)203-40-90
Красноярск (391)204-63-61
Курск (4712)77-13-04
Курган (3522)50-90-47
Липецк (4742)52-20-81

Магнитогорск (3519)55-03-13
Москва (495)268-04-70
Мурманск (8152)59-64-93
Набережные Челны (8552)20-53-41
Нижегний Новгород (831)429-08-12
Новокузнецк (3843)20-46-81
Ноябрьск (3496)41-32-12
Новосибирск (383)227-86-73
Ноябрьск (3496)41-32-12
Омск (3812)21-46-40
Орел (4862)44-53-42
Оренбург (3532)37-68-04
Пенза (8412)22-31-16
Петрозаводск (8142)55-98-37
Псков (8112)59-10-37

Пермь (342)205-81-47
Ростов-на-Дону (863)308-18-15
Рязань (4912)46-61-64
Самара (846)206-03-16
Саранск (8342)22-96-24
Санкт-Петербург (812)309-46-40
Саратов (845)249-38-78
Севастополь (8692)22-31-93
Симферополь (3652)67-13-56
Смоленск (4812)29-41-54
Сочи (862)225-72-31
Ставрополь (8652)20-65-13
Сыктывкар (8212)25-95-17
Сургут (3462)77-98-35
Тамбов (4752)50-40-97

Тверь (4822)63-31-35
Тольяти (8482)63-91-07
Томск (3822)98-41-53
Тула (4872)33-79-87
Тюмень (3452)66-21-18
Улан-Удэ (3012)59-97-51
Ульяновск (8422)24-23-59
Уфа (347)229-48-12
Хабаровск (4212)92-98-04
Чебоксары (8352)28-53-07
Челябинск (351)202-03-61
Череповец (8202)49-02-64
Чита (3022)38-34-83
Якутск (4112)23-90-97
Ярославль (4852)69-52-93

Киргизия (996)312-96-26-47

Россия (495)268-04-70

Казахстан (772)734-952-31

<https://martellato.nt-rt.ru> || mot@nt-rt.ru

КАТАЛОГ

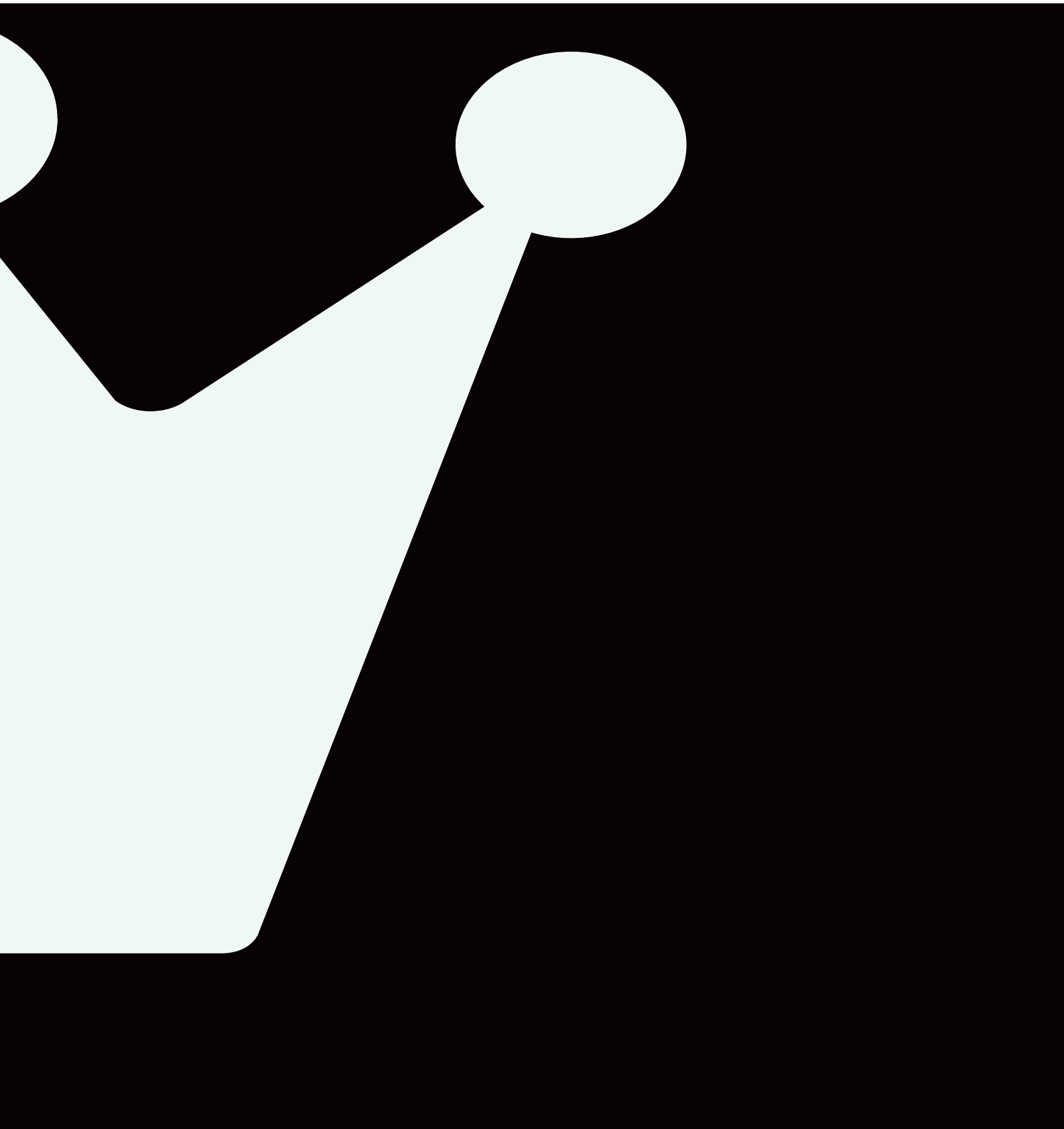

PROFESSIONAL EQUIPMENT

PASTRY, ICE CREAM & BAKERY

 Martellato

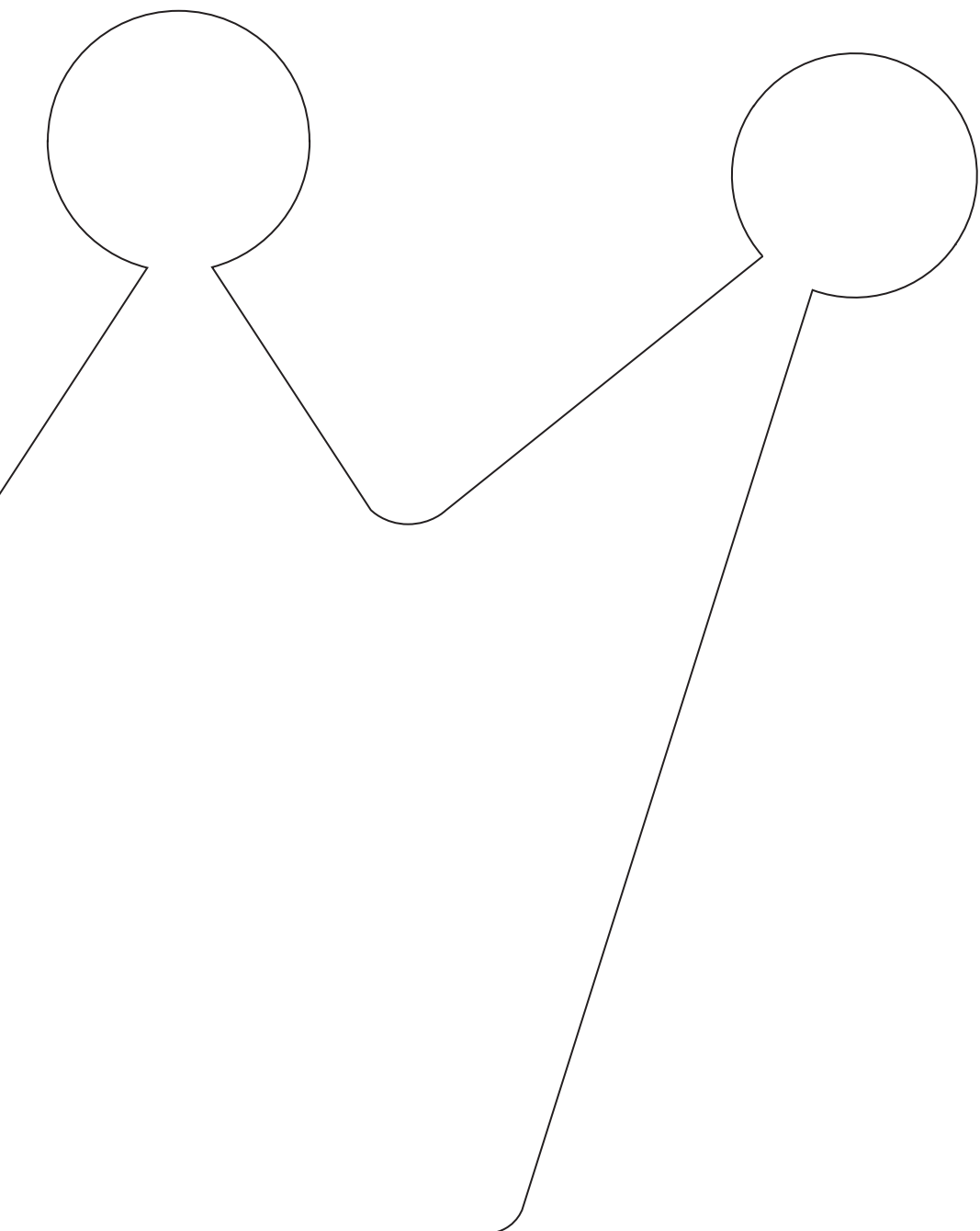

VISION

Essere ambasciatori del Made in Italy nel mondo, offrendo prodotti che permettano ai pasticceri di esprimere al meglio il loro talento.

Being ambassadors of Made in Italy all over the world, by offering products that allow pastry chefs to express their talent at their best.

7000 PRODUCTS

Una gamma completa, in costante crescita, studiata e realizzata per soddisfare le esigenze dei professionisti. Il nostro catalogo, dedicato alle attrezzature da laboratorio pensate per i pasticceri ed adatte a tutti i professionisti, raccoglie un'ampia gamma di articoli tradizionali ed innovativi e vuole rappresentare il punto di riferimento per i diversi settori del comparto food.

A complete range, constantly growing, designed and built for meet the needs of professionals. Our catalog, dedicated to laboratory tools designed for pastry chefs and suitable for all professionals, collects a wide range of traditional and innovative articles and wants to represent the reference point for the different sectors of the food industry.

MADE IN ITALY means Innovation and Design

Per noi, il "Made in Italy" è l'identità che esprime i valori del territorio e una particolare attenzione verso i prodotti. L'accurata scelta dei fornitori e delle nostre lavorazioni ci permette di offrire dei prodotti di alta qualità.

Made in Italy is for us the identity that expresses the values of the territory and a particular attention to products. The careful choice of suppliers and our manufacturing allows us to offer high quality products.



CERTIFIED QUALITY

Qualità e sicurezza di tutti i nostri prodotti e servizi, così come specializzazione, ricerca e formazione sono costantemente controllate per garantire standard elevati nel rispetto delle Normative Europee sulla sicurezza alimentare, ambientale e gestione aziendale.

Martellato è un'azienda con sistema di qualità certificato ISO 9001:2015.

The quality and safety of all our products and services, as well as the specialization, research and training are constantly monitored to guarantee high standards in accordance with European regulations of food and environmental safety and business management.

Martellato is a company with certified quality system ISO 9001: 2015.

AMBASSADORS

COLLABORATIONS



FRANK HAASNOOT



PHILIP KHOURY



KARIM BOURGI

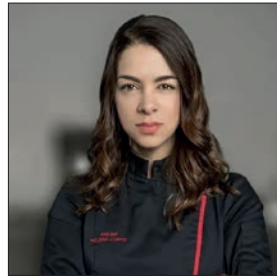

MELISSA COPPEL



JAVIER GUILLÉN



WEI LOON TAN



CAMILA GARCIA ELIZALDE



NICOLAS NIKOLAKOPOULOS



DAVID PALLÀS



VINESH JOHNY

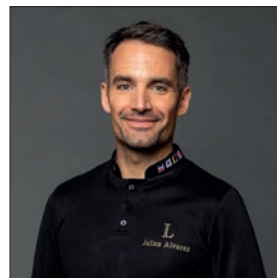

JULIEN ALVAREZ

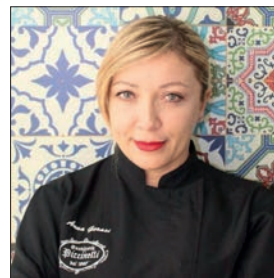

ANNA GERASI



LUC DEBOVE



LUIGI BIASETTO



MASSIMO CARNIO



GIUSEPPE GAGLIARDI

ACADEMIES

COLLABORATIONS

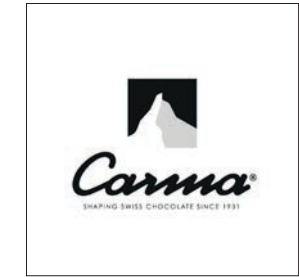

SUSTAINABILITY

L'impegno verso il Pianeta è parte della nostra filosofia.

Utilizzare **PROCESSI DI PRODUZIONE PIÙ EFFICIENTI** può ridurre in maniera significativa l'inquinamento, i rifiuti e i consumi:

Iniezione - questo sistema azzerava gli scarti produttivi, in quanto la materia prima viene utilizzata interamente. Inoltre, l'alta produttività degli impianti comporta una riduzione dei consumi.

Termoformatura - consente di stampare articoli di forme e dimensioni diverse e, contemporaneamente, di valorizzare gli scarti utilizzandoli come materia prima secondaria per altre produzioni.

Taglio laser - consente lavorazioni precise che utilizzano al massimo la materia prima, ottimizzando la produzione e riducendo gli scarti.

Ci impegniamo ad utilizzare **MATERIALI ECOLOGICI E RICICLABILI** per ridurre l'impatto ambientale. Il materiale riciclabile diventa così una risorsa per nuove produzioni

Commitment to the Planet is a part of our philosophy.

*Using more efficient **PRODUCTION PROCESSES** can significantly reduce pollution, waste and consumption:*

***Injection** - this system reduces production waste to zero, as the raw material is used entirely. In addition, the high productivity of the equipment leads to a reduction in consumption.*

***Thermoforming** - it allows articles of different shapes and sizes to be printed and, at the same time, to valorise waste by using it as a secondary raw material for other productions.*

***Laser cutting** - it allows precise processing that makes maximum use of the raw material, optimising production and reducing waste.*

*Commitment to use **ECOLOGICAL AND RECYCLABLE MATERIALS** in order to reduce environmental impact. Recyclable material thus becomes a resource for new production.*



REDUCE, REUSE, RECYCLE



Compiendo queste azioni, ogni azienda grande o piccola, ogni persona, tutti possiamo contribuire alla salvaguardia del pianeta.



Any company, either big or small, any person, all of us can contribute in safeguarding the planet.





A GIFT FOR THE PLANET



Il pianeta è un luogo che va salvaguardato.

Per questo abbiamo voluto dare un contributo condividendo con i nostri partner un importante progetto di riforestazione. Supportati dall'azienda Treedom, abbiamo acquistato 120 alberi di Cacao che sono stati piantati da contadini camerunensi in uno dei progetti agroforestali che l'azienda sostiene.

+ 120 ALBERI DI CACAO

Grazie a questa iniziativa, inoltre, Martellato contribuisce al finanziamento di contadini Camerunensi, sostenendo il loro lavoro e quindi il loro sostentamento.

CON QUESTI ALBERI COMPENSEREMO

7 tonnellate di CO₂

PARI A QUELLA PRODOTTA DA UN TRENO CHE PERCORRE 440,040 KM.

The planet is a place that must be preserved.

Which is why we wanted to make a contribution by sharing an important reforestation project with our partners.

+ 120 COCOA TREES

Supported by the company Treedom, we purchased 120 cacao trees that were planted by Cameroonian farmers in one of the agroforestry projects the company supports. Thanks to this initiative, our company also contributes to the funding of Cameroonian farmers, supporting their work and thus their livelihoods.

WITH THESE TREES WE WILL COMPENSATE

7 tons of CO₂

EQUAL TO THAT PRODUCED BY A TRAIN TRAVELLING 440,040 KM.

Treedom
CERTIFICATE 2022

Martellato

Martellato

120 Planted trees	-7 Tons of CO ₂

www.treedom.net

treedom friend
2022

SOCIOECONOMIC VALUE

Martellato a fianco di Remix per generare valore sociale.

Un'azienda socialmente responsabile concilia il proprio business con il rispetto e la valorizzazione delle persone.

Conscia di questo, Martellato srl dà il proprio contributo alla comunità sostenendo **Remix, una realtà che si occupa di inserimento lavorativo di persone fragili del territorio**, garantendo una filiera produttiva made in Italy, etica e sostenibile.

Nell'ambito dei progetti per l'accompagnamento e l'inserimento lavorativo, Remix ha sviluppato delle competenze altamente specifiche che dimostrano come anche le persone in situazione di fragilità possano contribuire positivamente all'economia del territorio, realizzando prodotti e servizi di qualità.

Martellato ha, quindi, scelto di affidare a Remix parte dell'assemblaggio dei propri prodotti. Acquistandoli supporterete direttamente questa realtà e il nostro impegno verso una società più inclusiva.



Martellato alongside Remix to generate social value.

*A socially responsible company reconciles its business with the respect and valorisation of people. Aware of this, Martellato srl makes its own contribution to the community by supporting **Remix, a reality that deals with the work placement of fragile people in the area**, guaranteeing a made in Italy, ethical and sustainable production chain.*

As part of its projects for accompaniment and job placement, Remix has developed highly specific skills that demonstrate how even people in fragile situations can make a positive contribution to the local economy, producing quality products and services. Martellato has therefore chosen to entrust Remix with part of the assembly of its products. By purchasing them you will directly support this reality and our commitment to a more inclusive society.



**BUY MORE
& ASK FOR
HIGH QUALITY**

INDEX



CHOCOLATE

PRALINES

Su richiesta alcuni modelli sono disponibili in versione BPA FREE.
On request, some models are available in a BPA FREE version.



mount in collaboration with
PHILIP KHOURY

Vip

VERY
IMPORTANT
PRALINE

Vip | VERY
IMPORTANT
PRALINE

Una linea di stampi che nasce dalla collaborazione tra Martellato e 4 Pastry Chef di fama internazionale per creare praline VIP.

From the collaboration between Martellato and 4 world renowned Pastry Chefs comes this line of moulds to create VIP pralines.

Polycarbonate moulds 275 x 175 mm

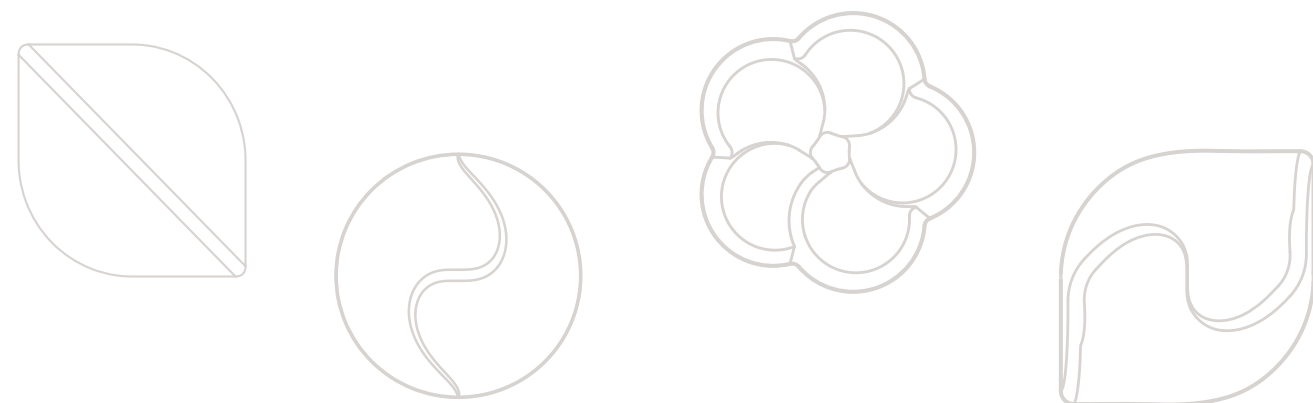

dune

KARIM BOURGI

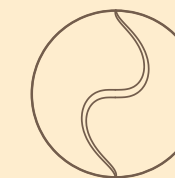

mount

PHILIP KHOURY

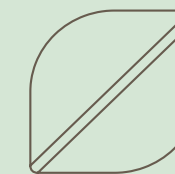

flow

WEI LOON TAN



flora

JAVIER GUILLÉN

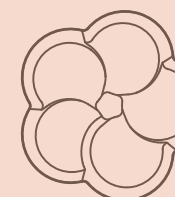

dune

mount

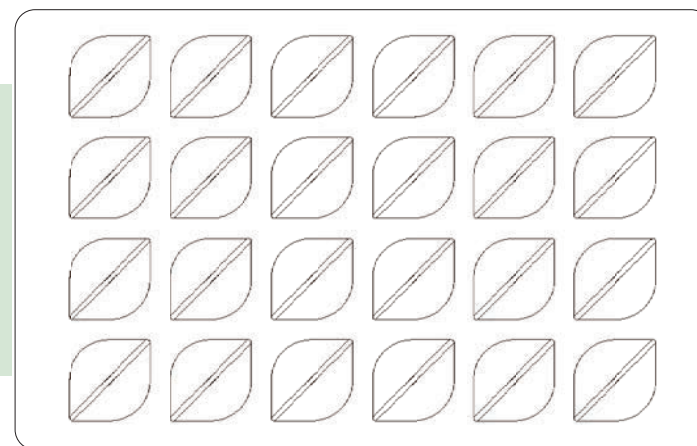
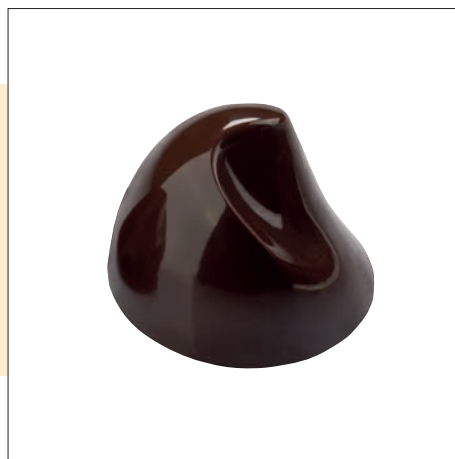

DUNE

MA1052
ø 31 h 21 mm ~ 10 gr
Prod. 24 pcs

MOUNT

MA1047
32 x 32 h 23 mm ~ 9 gr
Prod. 24 pcs



CREATED WITH

Karim Bourgi



CREATED WITH

Philip Khoury

flow

flora

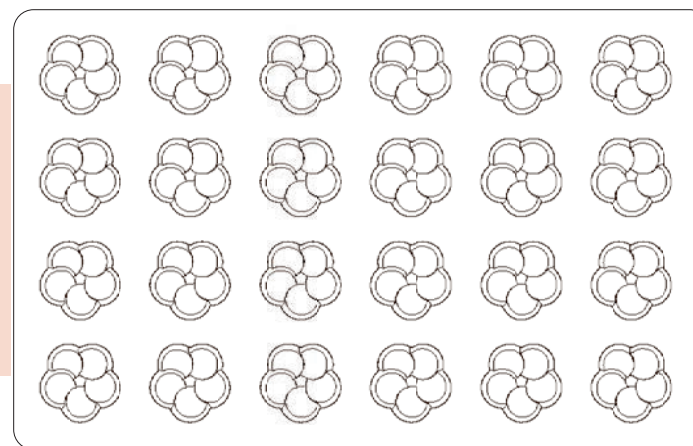
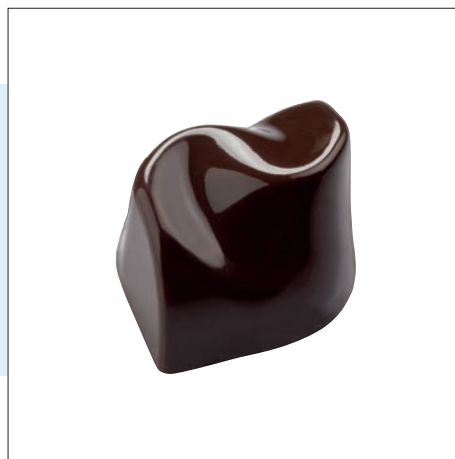
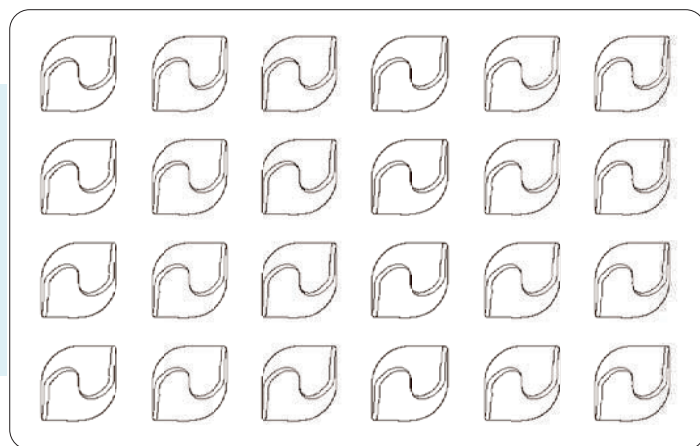

FLOW

FLORA

MA1051
29 x 29 h 18 mm ~ 11 gr
Prod. 24 pcs

MA1050
30 x 31 h 18 mm ~ 11 gr
Prod. 24 pcs



CREATED WITH

Wei Loon Tan



CREATED WITH

Javier Guillén



Contemporary

Forme moderne uno stile minimale caratterizzano le praline della linea Contemporary. Differenti modelli che ispirano e che si prestano a molteplici interpretazioni.

Modern shapes and a minimal style characterize the pralines of the Contemporary line. Different models that inspire and that lend themselves to multiple interpretations.

Polycarbonate moulds
275 x 175 mm

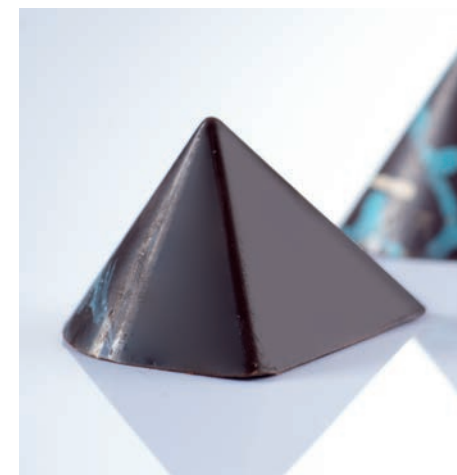

SIDE

MA1048
32 x 32 h 23 mm ~ 9 gr
Prod. 24 pcs



OBLIO

MA1049
ø 32 h 23 mm ~ 8 gr
Prod. 24 pcs



ROCKET

MA1044
Ø 23 h 29 mm ~ 9 gr
Prod. 28 pcs



THIMBLE

MA1045
Ø 23 h 28,5 mm ~ 11,5 gr
Prod. 28 pcs

Contemporary

Contemporary



TURN

MA1013
40 x 19 h 16 mm - 10 gr
Prod. 25 pcs



TWIST

MA1014
39,5 x 19 h 16 mm - 11 gr
Prod. 25 pcs



MA1969
40 x 20 h 18 mm ~ 8 gr
Prod. 30 pcs

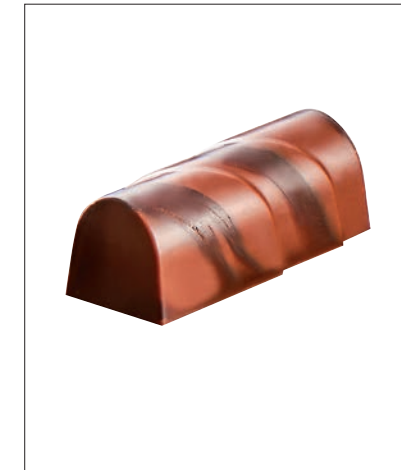

MA1970
40 x 18 h 15 mm ~ 9 gr
Prod. 30 pcs



MA1971
40 x 18 h 16 mm ~ 8 gr
Prod. 30 pcs



FLAT

MA1015
40 x 18 h 16 mm - 11 gr
Prod. 25 pcs



PILL

MA1016
40,5 x 18 h 16 mm - 10 gr
Prod. 25 pcs



MA1999
39 x 20 h 16 mm ~ 7 gr
Prod. 27 pcs



MA1998
39 x 18 h 15,5 mm ~ 10 gr
Prod. 30 pcs

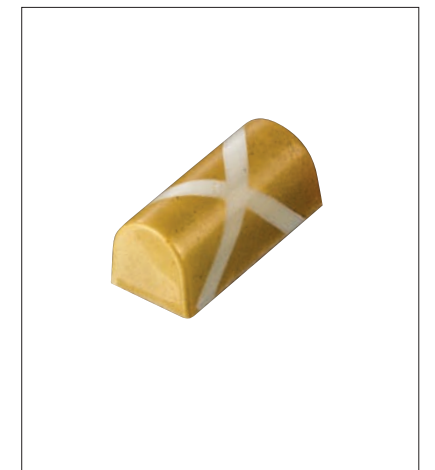

MA1997
39 x 18 h 15,5 mm ~ 10 gr
Prod. 30 pcs



architecture

Ispirate dalle linee armoniose delle volte architettoniche, le nuove praline riproducono i diversi stili. Come i più famosi architetti potrete realizzare vere e proprie opere d'arte.

Inspired by the harmonious lines of architectural vaults, the new pralines reproduce different styles. Like the most famous architects, you can create real works of art.

Polycarbonate moulds 275 x 175 mm

PAVILION

MA1041
27 x 27 h 20 mm ~ 10 gr
Prod. 28 pcs



VAULT

MA1042
26,5 x 26,5 h 20 mm ~ 9 gr
Prod. 28 pcs



CROSS

MA1043
26,5 x 26,5 h 18 mm ~ 11 gr
Prod. 28 pcs

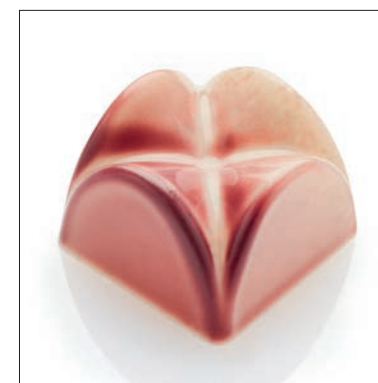

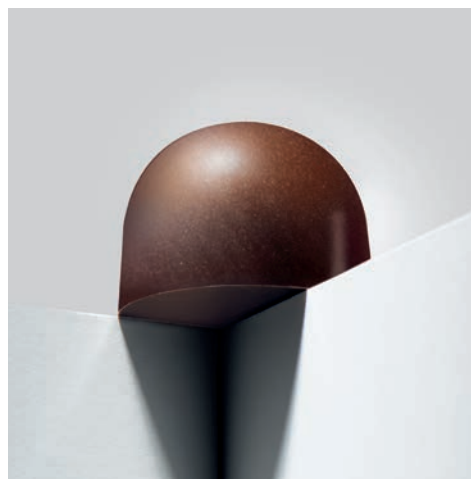

DOME

MA1038
PRALINE/SNACK Ø 43 h 33 mm
~ 40 gr - Prod. 12 pcs



STUD

MA1039
PRALINE/SNACK 45 x 45 h 33 mm
~ 34 gr - Prod. 12 pcs



PASTRY

MA1040
PRALINE/SNACK Ø 45 h 33 mm
~ 38 gr - Prod. 12 pcs



SWEET 1
MA1021
ø 32 h 23 mm
10 gr - Prod. 25 pcs



SWEET 2
MA1022
ø 32 h 21 mm
11 gr - Prod. 25 pcs



SWEET 3
MA1023
ø 32 h 19,5 mm
11 gr - Prod. 25 pcs



SWEET 4
MA1024
ø 33 h 22 mm
10 gr - Prod. 25 pcs

waves

PRALINE

Polycarbonate moulds 275 x 175 mm



WAVES 1

MA1003

26,9 x 59 x h 16 mm ~ 10,4 gr
Prod. 14 pcs



WAVES 3

MA1005

24,3 x 61,5 h 15,4 mm ~ 9,8 gr
Prod. 16 pcs

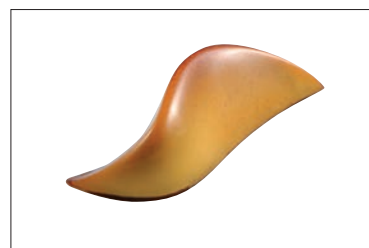

WAVES 2

MA1004

27 x 59 h 17 mm ~ 7,9 gr
Prod. 16 pcs



WAVES 4

MA1006

43,8 x 38,1 h 14,1 mm ~ 9,4 gr
Prod. 15 pcs



Polycarbonate moulds 275 x 175 mm

Double



DOMES

MA4010

38 x 26 h 19 mm ~ 11 gr
Prod. 4 pcs



CUBES

MA4011

36 x 25 h 16 mm ~ 10 gr
Prod. 24 pcs



HEARTS

MA4012

43 x 26 h 16 mm ~ 11 gr
Prod. 20 pcs



HEARTS

MA1993
33 x 33 h 15 mm ~ 10 gr
Prod. 24 pcs



JEMS

MA1994
6 square - 30 x 30 h 15 mm ~ 11 gr
6 oval - 42 x 24 h 15 mm ~ 10 gr
6 round - ø 32 h 15 mm ~ 10 gr



BANANA

MA1033
64 x 19 h 15 mm - 10 gr
Prod. 16 pcs



PERA

MA1034
44 x 32 h 17 mm - 11 gr
Prod. 18 pcs

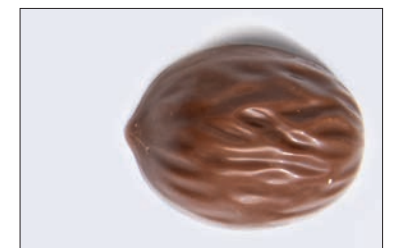

NOCE

MA1035
37 x 29 h 17,5 mm - 11 gr
Prod. 18 pcs



ARACHIDE

MA1036
50 x 23 h 15,5 mm - 11 gr
Prod. 20 pcs

Geometric Pralines



QUADRATO
MA1008
25 x 25 h 15,5 mm
11 gr - Prod. 28pcs



CERCHIO
MA1007
ø 30 h 15,5 mm
11 gr - Prod. 28pcs



OTTAGONO
MA1010
ø 30 h 15,5 mm
11 gr - Prod. 28pcs



TRIANGOLO
MA1009
33 x 29 h 15,5 mm
8 gr - Prod. 24pcs

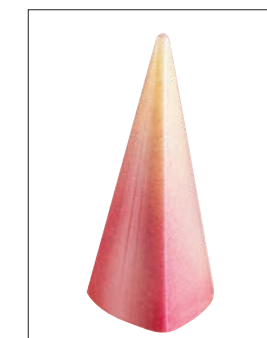

TRIANGULAR
MA4005
25 x 26 h 55 mm - 11 gr
Prod. 28 pcs

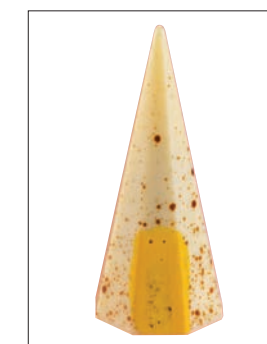

OCTAGONAL
MA4006
25 x 25 h 55 mm - 11 gr
Prod. 28 pcs

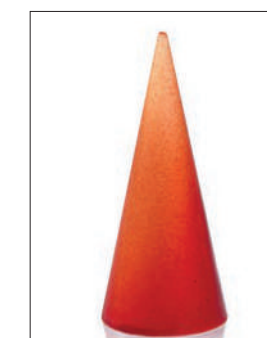

CONE
MA4007
25 x 25 h 55 mm - 11 gr
Prod. 28 pcs

Tridimensional Shapes



Polycarbonate moulds
275 x 175 mm with magnets



20-3D2002
26 x 26 h 26 mm
~ 8 gr - 28 pcs



20-3D2003
26 x 26 h 26 mm
~ 8 gr - 28 pcs



20-3D3001
26 x 26 h 26 mm
~ 8 gr - 28 pcs



20-3D4001
28 x 24 h 24 mm
~ 8 gr - 28 pcs

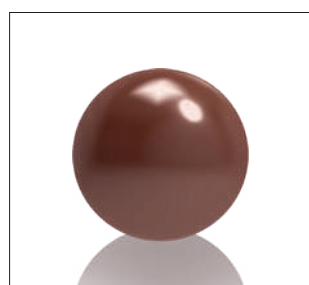

20-3D2001
26 x 26 h 26 mm
~ 8 gr - 28 pcs



20-3D1001
23 x 30 h 23 mm
~ 8 gr - 28 pcs



20-3D1003
23 x 30 h 23 mm
~ 8 gr - 28 pcs



20-3D1002
23 x 32 h 23 mm
~ 8 gr - 28 pcs



20-3D5001
31 x 27 h 21 mm
~ 8 gr - 28 pcs

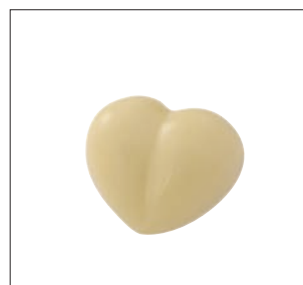

20-3D6001
32 x 18 h 28 mm
~ 8 gr - 28 pcs



20FRUIT01
ø 28 h 27 mm
~ 12 gr - 28 pcs



20FRUIT02
ø 26 h 36 mm
~ 12 gr - 28 pcs



20FRUIT03
Ø 28 h 32 mm
~ 12 gr - 28 pcs



20FRUIT04
Ø 25 h 31 mm
~ 12 gr - 28 pcs



20FRUIT05
Ø 27 h 30 mm
~ 12 gr - 28 pcs

Classic Shapes

Polycarbonate moulds 275 x 175 mm



MA1002
ø 30 h 19 mm
~ 12 gr - 28 pcs



MA1082
35 x 20 h 17 mm
~ 12 gr - 30 pcs



MA1094
ø 30 h 22 mm
~ 14 gr - 28 pcs



MA1530
ø 26 h 19 mm
~ 9 gr - 40 pcs



MA1631
30 x 18 h 15 mm
~ 7 gr - 30 pcs



MA1019
25 x 25 h 23 mm
~ 3 gr - 40 pcs



MA1032
38 x 22 h 15 mm
~ 10 gr - 32 pcs



MA1037
ø 29 h 21 mm
~ 8 gr - 40 pcs



MA1046
37 x 31 h 16 mm
~ 12 gr - 28 pcs





MA1927
ø 26 h 23 mm
~ 11 gr - 28 pcs



MA1018
52 x 26 x h 14 mm
~ 9 gr - 21 pcs



MA3007
26 x 26 x h 12 mm
~ 8,5 gr - 28 pcs



MA1609
30 x 23 h 18 mm
~ 9 gr - 24 pcs



MA1611
Ø 30 h 15 mm
~ 9 gr - 24 pcs



MA1064
35 x 23 h 16 mm
~ 9 gr - 36 pcs



MA1606
30 x 30 h 12 mm
~ 9 gr - 24 pcs



MA1281
17 x 12 h 5 mm
~ 1 gr - 130 pcs



MA1640
48 x 18,5 h 19 mm
~ 9 gr - 16 pcs



MA1636
30 x 30 h 15 mm
~ 8 gr - 24 pcs



MA1637
32 x 24 h 15 mm
~ 8 gr - 30 pcs



MA1638
34 x 25 h 15 mm
~ 8 gr - 30 pcs



MA1612
38 x 30 h 15 mm
~ 9 gr - 20 pcs



MA1607
Ø 28 h 17,5 mm
~ 9 gr - 24 pcs



MA1618
Ø 30 h 20 mm
~ 9 gr - 24 pcs



MA1629
30 x 18 h 15 mm
~ 8 gr - 30 pcs



MA1632
30 x 18 h 15 mm
~ 8 gr - 30 pcs



MA1011
50 x 25 h 15 mm
~ 9 gr - 21 pcs



MA1012
54 x 24 h 16 mm
~ 9 gr - 21 pcs

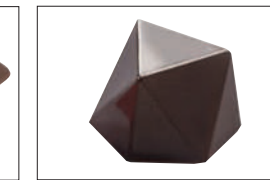

MA1925
27 x 31 h 18 mm
~ 9,5 gr - 28 pcs



MA1633
Ø 26 h 15 mm
~ 8 gr - 35 pcs



MA1527
31 x 24 h 13 mm
~ 8 gr - 35 pcs



MA1529
32 x 22 h 15 mm
~ 8 gr - 42 pcs



MA1616
27 x 27 h 13 mm
~ 9 gr - 28 pcs



MA1621
33 x 33 h 15 mm
~ 9 gr - 24 pcs



MA1972
26 x 26 h 20 mm
~ 7 gr - 30 pcs



MA1293
Ø 23 h 21 mm
~ 12 gr - 28 pcs



MA1521
Ø 28 h 18 mm
~ 10 gr - 28 pcs



MA1603
32 x 23 h 13 mm
~ 8 gr - 24 pcs



MA1627
35 x 20 h 15 mm
~ 7 gr - 30 pcs



MA1907
29,5 x 19 h 17 mm
~ 7 gr - 28 pcs



MA1617
31 x 23 h 12 mm
~ 9 gr - 24 pcs



MA1620
33 x 25 h 12 mm
~ 8 gr - 24 pcs



MA1622
30 x 24 h 12 mm
~ 9 gr - 24 pcs

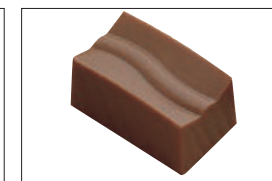

MA1625
30 x 18 h 15 mm
~ 8 gr - 30 pcs



MA1303
27 x 27 h 18 mm
~ 11 gr - 28 pcs



MA1335
35 x 22 h 15 mm
~ 7 gr - 30 pcs



MA1350
Ø 25,5 h 21,5 mm
~ 11 gr - 30 pcs



MA1604
30 x 25 h 15 mm
~ 9 gr - 24 pcs



MA1626
31 x 20 h 16 mm
~ 7 gr - 30 pcs



MA1619
29 x 29 h 12 mm
~ 9 gr - 18 pcs

MA1800
21 x 21 h 18,5 mm
~ 8 gr - 28 pcs

MA1801
26 x 20 h 21 mm
~ 8 gr - 28 pcs

MA1802
Ø 23 h 18,5 mm
~ 7 gr - 28 pcs

MA1803
26 x 20 h 21 mm
~ 8 gr - 28 pcs



MA1804
Ø 25 h 18,5 mm
~ 8 gr - 28 pcs

MA1900
29 x 19 h 16 mm
~ 8 gr - 28 pcs

MA1901
27 x 23 h 14 mm
~ 8 gr - 28 pcs

MA1904
30 x 20 h 17,5 mm
~ 8 gr - 28 pcs

MA1905
30,5 x 19,5 h 18 mm
~ 8 gr - 28 pcs



MA1025
33 x 22 h 20 mm
~ 15 gr - 30 pcs

MA1074
38 x 28 h 18 mm
~ 15 gr - 30 pcs

MA1091
Ø 28 h 23 mm
~ 10 gr - 40 pcs

MA1610
Ø 29 h 18 mm
~ 9 gr - 24 pcs

MA1903
28 x 20 h 17 mm
~ 7 gr - 28 pcs



MA1624
28 x 32 h 15 mm
~ 8 gr - 32 pcs

MA1965
25 x 25 h 15 mm
~ 9 gr - 30 pcs

MA1966
25 x 25 h 15 mm
~ 9 gr - 30 pcs

MA1968
25 x 25 h 15 mm
~ 9 gr - 30 pcs

MA1964
Ø 27 h 20 mm
~ 9 gr - 30 pcs



MA1980
25 x 25 h 13 mm
~ 9 gr - 24 pcs

MA1981
Ø 35 h 15 mm
~ 10 gr - 24 pcs

MA1963
Ø 27 h 20 mm
~ 9 gr - 30 pcs

Polycarbonate moulds 275 x 175 mm



MA1982
28 x 28 h 16 mm
~ 11 gr - 28 pcs

MA1983
24 x 24 h 18 mm
~ 10 gr - 28 pcs

MA1985
41 x 24 h 20 mm
~ 10 gr - 20 pcs

MA5000
ø 30 mm
24 cavity

MA5008
ø 35 mm
15 cavity



MA1987
35 x 23 h 17 mm
~ 10 gr - 24 pcs

MA2003
20 x 20 h 16 mm
~ 6 gr - 28 pcs

MA1988
30 x 30 h 8 mm
~ 8 gr - 24 pcs



MA1984
40 x 42 h 16 mm
~ 10 gr - 15 pcs

MA1986
30 x 30 h 11 mm
~ 11 gr - 28 pcs

MA1989
Ø 35 h 8 mm
~ 8 gr - 24 pcs



MA1020
25 x 25 h 18 mm
~ 11 gr - 28 pcs

MIXED Shapes

Polycarbonate moulds 275 x 175 mm



MA1994
 6 square - 30 x 30 h 15 mm ~ 11 gr
 6 oval - 42 x 24 h 15 mm ~ 10 gr
 6 round - Ø 32 h 15 mm ~ 10 gr



MA1958
 30 x 24 h 18 mm
 5 x 6 pcs ~ 10 gr



MA1961
 30 x 25 h 25 mm
 5 x 6 pcs ~ 8 gr



MA1977
 30 x 24 h 11 mm
 5 x 6 pcs ~ 7 gr

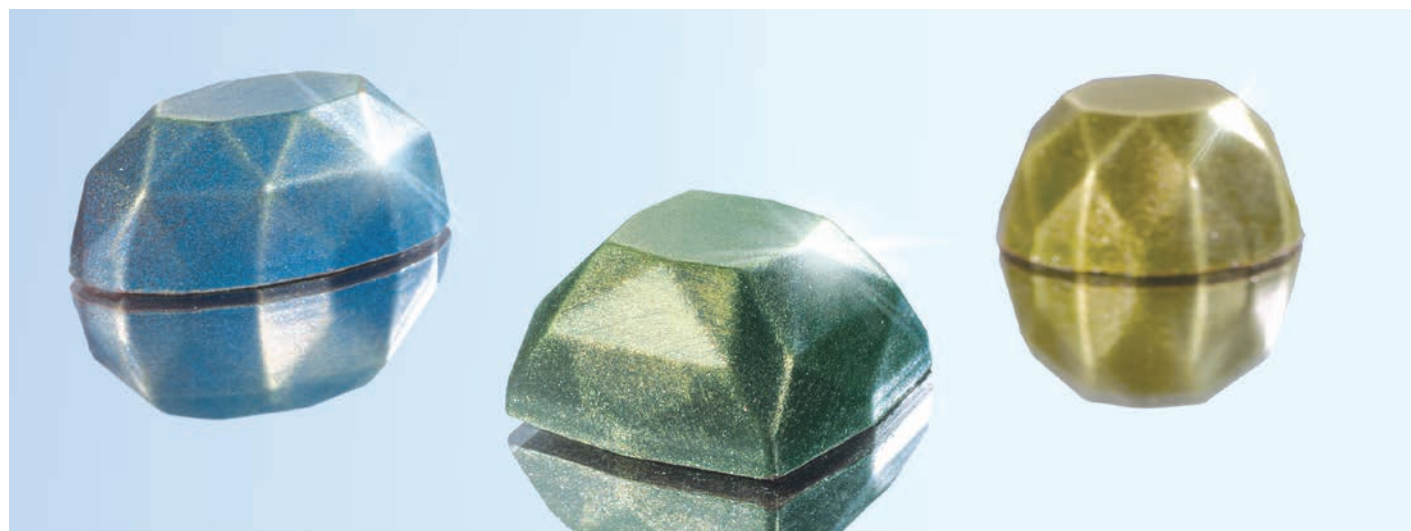

Semispheres



Polycarbonate moulds 275 x 175 mm



MA5003

Ø 20 mm - Prod. 45 pcs
 Peso semisfera piena/full
 semisphere weight ~ 2,5 gr

MA5008

Ø 35 mm - Prod. 15 pcs
 Peso semisfera piena/full
 semisphere weight ~ 13 gr
 Peso semisfera con camicia/
 semisphere with shell ~ 8 gr

MA5001

Ø 50 mm - Prod. 8 pcs
 Peso semisfera/semisphere
 weight ~ 17 gr
 Camicia/shell: 3 mm

MA5006

Ø 80 mm - Prod. 4 pcs
 Peso semisfera/semisphere
 weight ~ 50 gr
 Camicia/shell: 3 mm

MA5007

Ø 25 mm - Prod. 28 pcs
 Peso semisfera piena/full
 semisphere weight ~ 5 gr
 Camicia/shell: 3 mm

MA5004

Ø 40 mm - Prod. 15 pcs
 Peso semisfera/semisphere
 weight ~ 11 gr
 Camicia/shell: 3 mm

MA5010

Ø 55 mm - Prod. 6 pcs
 Peso semisfera/semisphere
 weight ~ 20 gr
 Camicia/shell: 3 mm

MA5002

Ø 100 mm - Prod. 2 pcs
 Peso semisfera/semisphere
 weight ~ 80 gr
 Camicia/shell: 3 mm

MA5000

Ø 30 mm - Prod. 24 pcs
 Peso semisfera piena/full
 semisphere weight ~ 9 gr

MA5009

Ø 45 mm - Prod. 12 pcs
 Peso semisfera/semisphere
 weight ~ 13 gr
 Camicia/shell: 3 mm

MA5005

Ø 60 mm - Prod. 6 pcs
 Peso semisfera/semisphere
 weight ~ 25 gr
 Camicia/shell: 3 mm

Thermoformed moulds



Kit 6 Stampi - Moulds - BIG
20SF001

Ø 100 mm - prod 1 pc Ø 150 mm - prod 1 pc
 Ø 130 mm - prod 1 pc Ø 175 mm - prod 1 pc
 Ø 140 mm - prod 1 pc Ø 200 mm - prod 1 pc



Kit 4 Stampi - Moulds - SMALL
20SF002

Ø 50 mm - prod 6 pcs Ø 75 mm - prod 4 pcs
 Ø 65 mm - prod 4 pcs Ø 90 mm - prod 2 pcs

Stampi - Moulds: 225x225 mm

Stampi - Moulds: 225x225 mm - 175x175 mm

Love Day

Polycarbonate moulds 275 x 175 mm



HEARTS
MA1993
33 x 33 h 15 mm
Prod. 24 pcs ~ 10 gr



LOVE 2
MA1526
30,5 x 28 h 16,5 mm
Prod. 35 pcs ~ 8 gr



LOVE 1
MA1513
34 x 33 h 11 mm
Prod. 28 pcs ~ 7 gr



LOVE 3
MA1613
40 x 42 h 15 mm
Prod. 15 pcs ~ 9 gr



LOVE 4
MA1962
31 x 27 h 14 mm
Prod. 30 pcs ~ 8 gr

Mum & Dad

Polycarbonate moulds 275 x 175 mm



DEEP HEART

MA1056
27 x 27 h 16 mm
Prod. 28 pcs ~ 11 gr



DAFNE

MA1055
ø 35 x h 16 mm
Prod. 24 pcs ~ 11 gr

CHOCO *Light*

Stampi termoformati per realizzare soggetti e decorazioni.
Thermoformed mould for figures and decorations.



90-1001
Ø 23 h9
18 pcs



90-1004
Ø 33 h9
18 pcs



90-1026
52x42 h12
8 pcs



90-1212
152x78 h8
3 pcs



BOLT

MA1054
31 x 27 x h 16 mm
Prod. 24 pcs ~ 11 gr



JOE

MA1053
16 x 54 h 16 mm
Prod. 16 pcs ~ 10 gr

Halloween Day

Polycarbonate moulds 275 x 175 mm



SKULL

MA1017
37 x 28 h 18 mm
Prod. 20 pcs ~ 10 gr



PUMPKIN

MA1992
34 x 31 h 15 mm ~ 9+9gr
Prod. 12+12 pcs



XMAS Days

Polycarbonate moulds 275 x 175 mm



STAR

MA1984
40 x 42 h 16 mm ~ 10gr
Prod. 15 pcs



GIFT

MA1991
26 x 26 h 20 mm ~ 11gr
Prod. 28 pcs



PANDORO

MA1990
Ø 30 h 25 mm ~ 10gr
Prod. 24 pcs



BOTTLE

MA3011
60 x 20,5 h 16 mm ~ 12 gr
Prod. 18 pcs



SPHERE

MA1974
30 x 26 h 16,5 mm ~ 7gr
Prod. 5 x 6 pcs



TREE

MA1975
31 x 22 h 22 mm ~ 7gr
Prod. 5 x 5 pcs

BARS

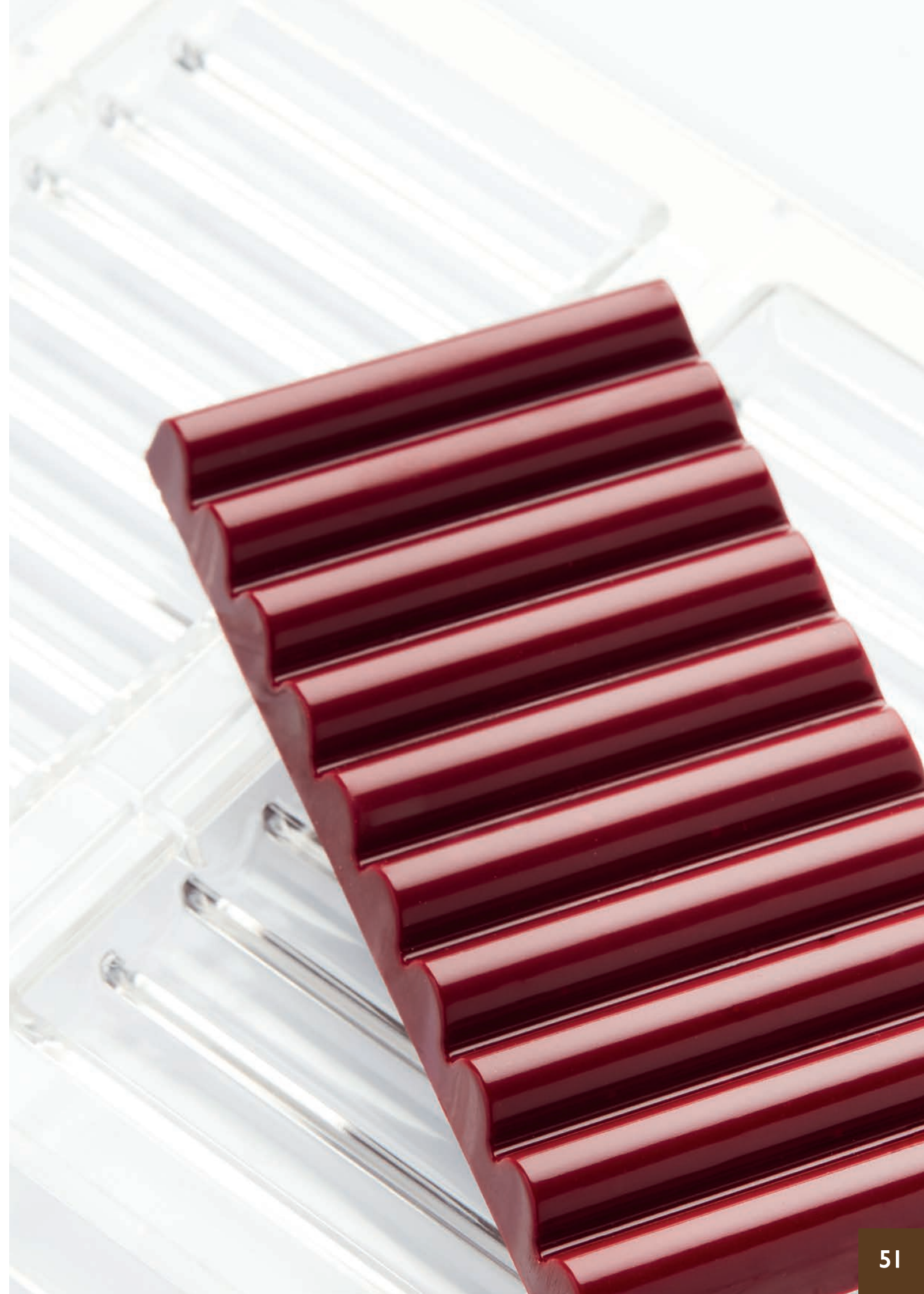

EVOLUTION

Thinking beyond
chocolate

Polycarbonate moulds 275 x 175 mm

La collezione Evolution, nata per interpretare le tendenze del momento, si esprime con forme essenziali e geometrie. Le linee si incontrano ed intrecciano nelle nuove tavolette, che richiamano trame e sinuosità, oltre a giochi di volume.

The Evolution collection, created to interpret the trends of the moment, expresses itself with essential shapes and geometries. The lines meet and interlace in the new bars, which recall textures and sinuosity, as well as playing with games of volume.



SWING

MA2028

BAR - 142 x 68 h 10,5 mm
Prod. 3 pcs ~ 100 gr



WEAVE

MA2029

BAR - 140 x 70 h 11 mm
Prod. 3 pcs ~ 100 gr



PEAK

MA2027

BAR - 142 x 68 h 12 mm
Prod. 3 pcs ~ 100 gr

EVOLUTION

Polycarbonate moulds 275 x 175 mm

KALEIDOS

MA2019
BAR - 130 x 75 h 9 mm
Prod. 3 pcs ~ 85 gr



EXAGON

MA2015
BAR - 140 x 68,5 h 13,5 mm
Prod. 3 pcs ~ 100 gr



MIRROR

MA2022
BAR - 138 x 72 h 9 mm
Prod. 3 pcs ~ 86 gr

EVOLUTION

Polycarbonate moulds 275 x 175 mm

STONE

MA2013
BAR - 70 x 70 h 11 mm
Prod. 6 pcs ~ 50 gr



SQUARE

MA2014
BAR - 70 x 70 h 11 mm
Prod. 6 pcs ~ 50 gr

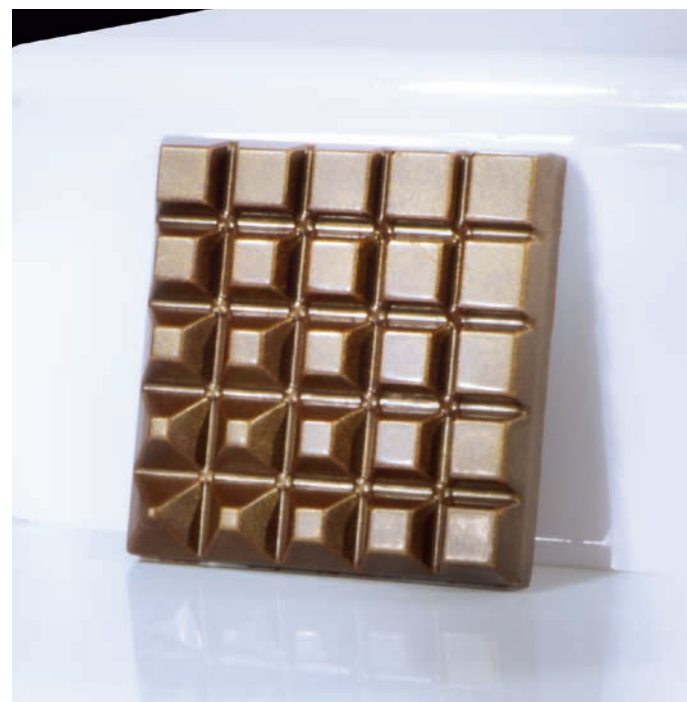

SIGNS

Polycarbonate moulds 275 x 175 mm

KUBE

MA2016
BAR - 137 x 72 h 10 mm
Prod. 3 pcs ~ 100 gr

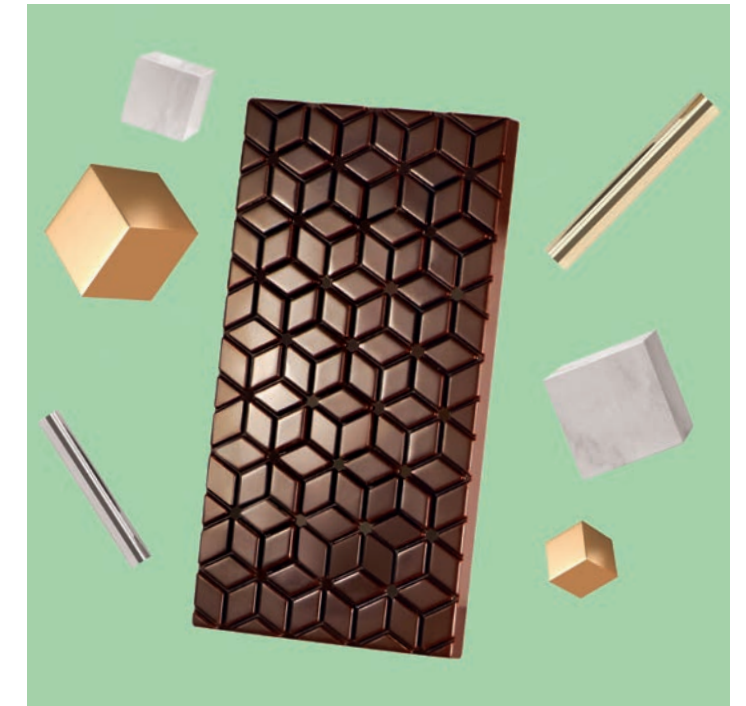

LOVE

MA2017
BAR - 137 x 71 h 9,5 mm
Prod. 3 pcs ~ 100 gr



ICONICS



Forme che si ispirano alle più iconiche tavolette. L'interpretazione di ogni cioccolatiere sarà l'elemento innovativo che sorprenderà e ne differenzierà lo stile.

Shapes inspired by the most iconic bars. The interpretation of each chocolatier will be the innovative element that will surprise and differentiate the style.

Polycarbonate moulds 275 x 175 mm

KIT

MA2023
BAR - 138 x 69 h 11 mm
Prod. 3 pcs ~ 100 gr

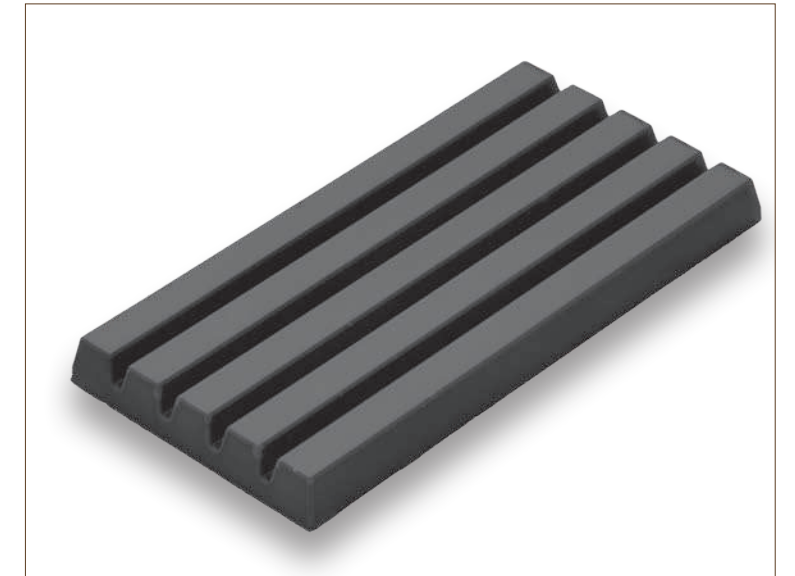

SLOT

MA2026
BAR - 140 x 70,5 h 10 mm
Prod. 3 pcs ~ 100 gr

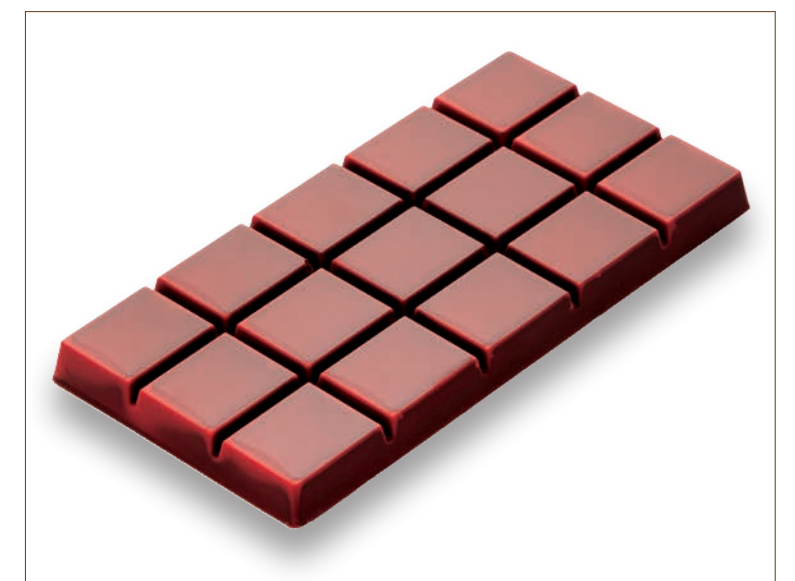

LOG

MA2024
BAR - 140 x 69,5 h 11 mm
Prod. 3 pcs ~ 100 gr

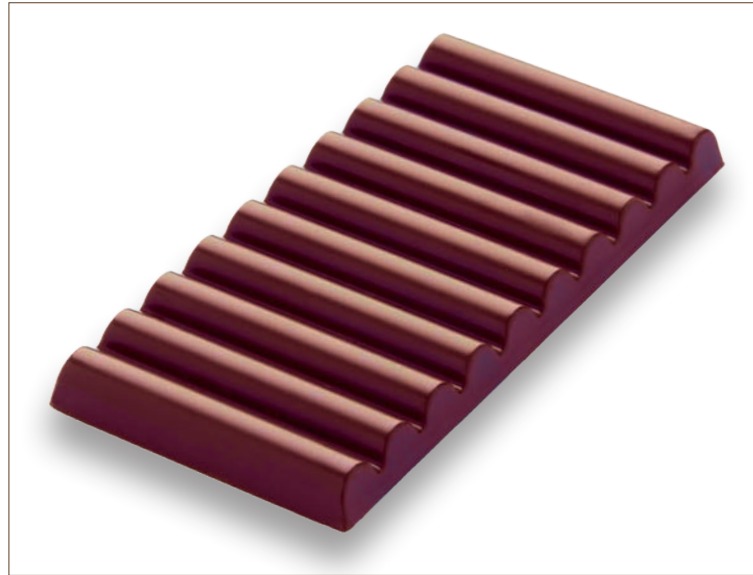

BLOCK

MA2025
BAR - 139 x 69,5 h 11,5 mm
Prod. 3 pcs ~ 100 gr

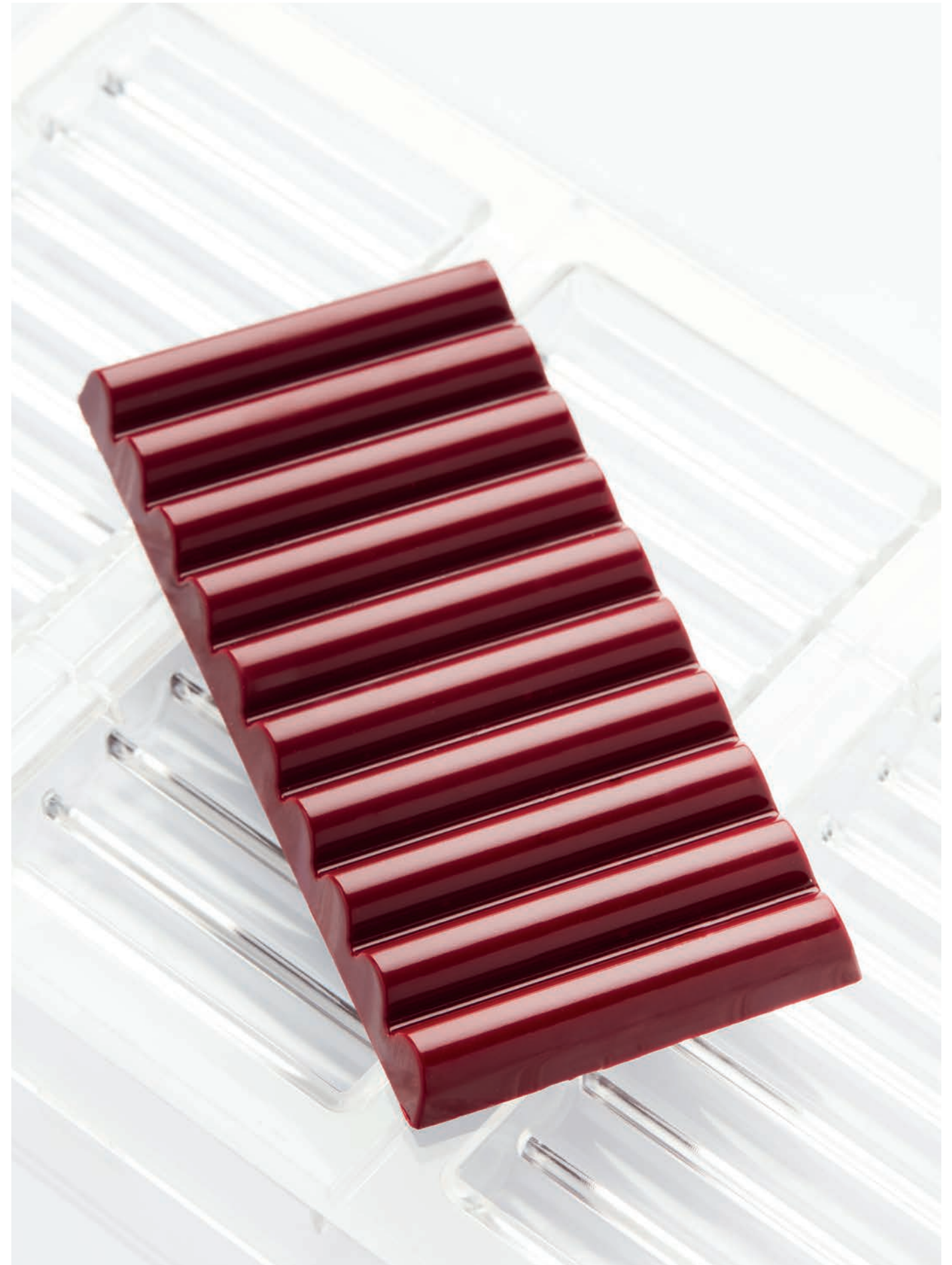

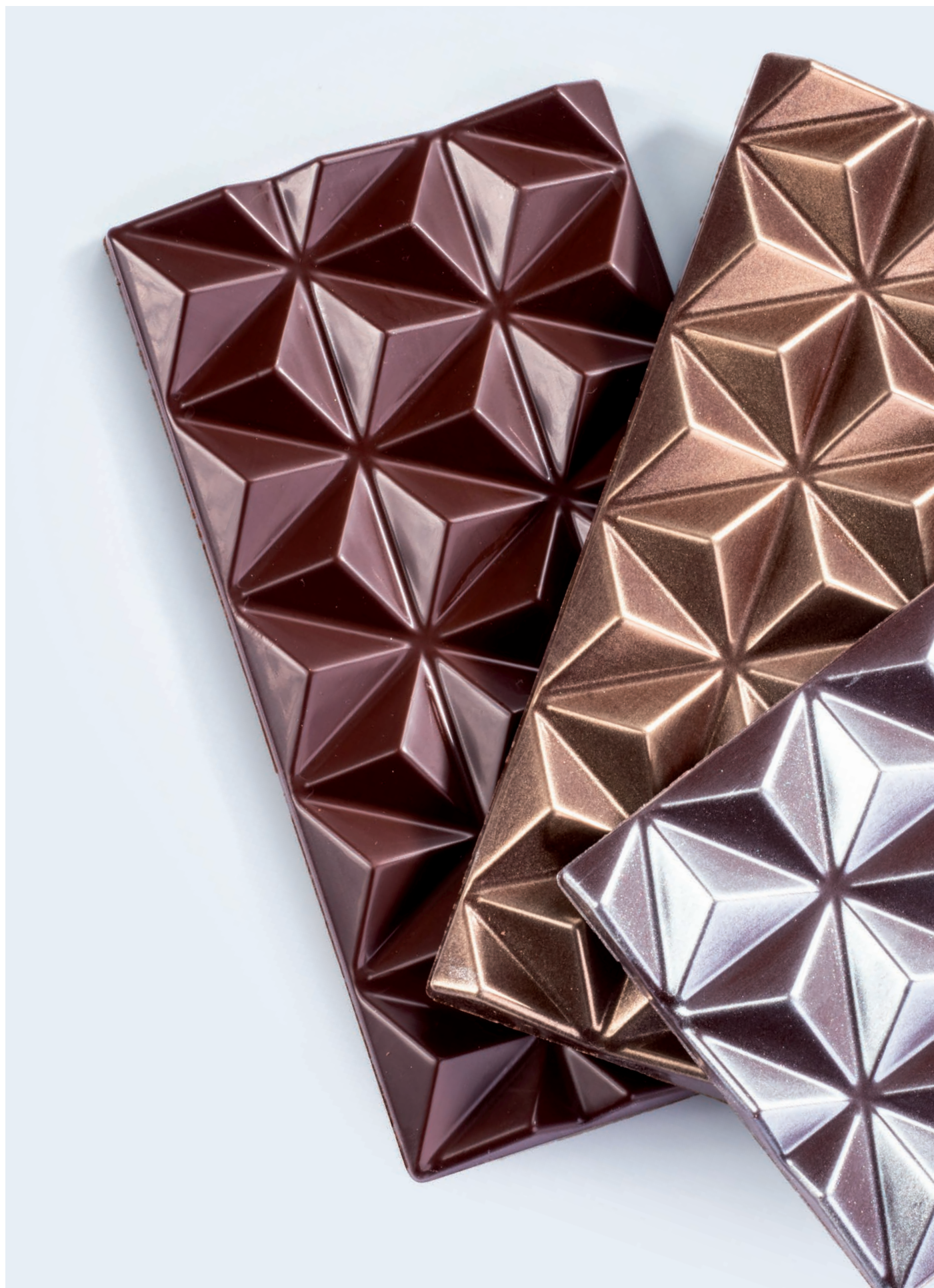

CHOCO

Style

Polycarbonate moulds 275 x 175 mm

PYRAMID

MA2009
138 x 72 h 11 mm
Prod. 3 pcs ~ 80 gr



LIQUID

MA2008
117 x 71 h 13 mm
Prod. 3 pcs ~ 80 gr



PRESTIGE

Polycarbonate moulds 275 x 175 mm



MINI QUILTED
MA2020
 BAR - 133 x 70 x h 10 mm
 Prod. 3 pcs ~ 82 gr



QUILTED
MA2021
 BAR - 132 x 66 h 10 mm
 Prod. 3 pcs ~ 80 gr

choco and the City

Polycarbonate moulds 275 x 175 mm



COCOA
MA2012
 BAR - 130 x 70 x h 8 mm
 Prod. 3 pcs ~ 83 gr



CITY BAR
MA2011
 BAR - 105 x 76 h 7 mm
 Prod. 3 pcs ~ 80 gr

Classic Shapes

Polycarbonate moulds 275 x 175 mm



MA2010
132 x 68 h 11 mm
Prod. 3 pcs ~ 80 gr



MA2000
150 x 70 h 11 mm
Prod. 3 pcs ~ 110 gr



MA2001
160 x 75 h 8 mm
Prod. 3 pcs ~ 110 gr



MA2004
130 x 55 h 8 mm
Prod. 4 pcs ~ 65 gr



MA2005
157 x 78 h 7 mm
Prod. 3 pcs ~ 65 gr



MA1807
154 x 74 h 10 mm
Prod. 3 pcs ~ 125 gr

Light Choco bars

Thermoformed moulds

Essenziali stampi in plastica termoformata per tavolette che garantiscono risultati perfetti. Leggeri e pratici, consentono di realizzare artigianalmente esclusive tavolette di cioccolato in modo semplice e veloce.

Essential thermoformed plastic moulds for bars that guarantee perfect results. Light and practical, they allow to quickly and easily create exclusive handmade chocolate bars.



20TC004
150x70 h 8 mm
Pack 5 pcs
~100 gr



20TC005
130x55 h 8 mm
Pack 5 pcs
~70 gr



20TC006
110x50 h 8 mm
Pack 5 pcs
~45 gr



20TC001
150x70 h10mm
Pack 5 pcs
~100 gr



20TC002
150x70 h10mm
Pack 5 pcs
~100 gr



20TC003
150x70 h10mm
Pack 5 pcs
~100 gr

CHOCOLATE DISPLAYS

VERTICAL

80ET007
91 x 226 h 73/93 mm
Cap. ~ 16 pcs



HORIZONTAL

80ET008
181 x 226 h 43/156 mm
Cap. ~ 16 pcs (standing)/
~ 32 pcs (laying)

Con taschina removibile per inserire
grafica personalizzata/ with removable
pocket to insert customized graphics



DOUBLE

80ET009
180 x 220 h 255 mm
Cap. ~ 16 pcs (standing)/
~ 32 pcs (laying)



ET004
245x300 h 290mm
Cap. ~ 45 pcs



ET003
310x200 h 400mm
Cap. ~ 48 pcs



ET004B
315x410 h 370mm
Cap. ~ 80 pcs



SNACKS





PRISMA

MA7002
 SNACK/BAR 202 x 32 h 19 mm
 Prod. 4 pcs ~ 70 gr



BUBBLE

MA7001
 SNACK/BAR 200 x 23 h 17 mm
 Prod. 4 pcs ~ 70 gr

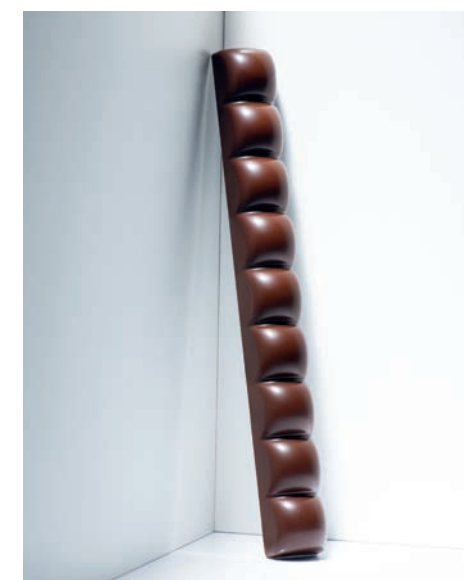

KITE

MA7000
 SNACK/BAR - 200 x 23 h 18 mm
 Prod. 4 pcs ~ 62 gr



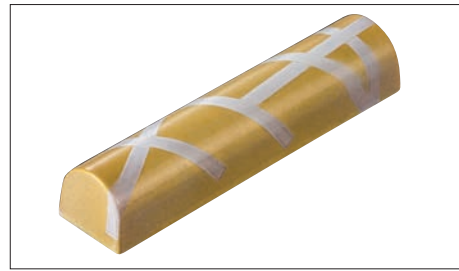

CURVY
MA1920
96 x 22 h 17 mm - 10 pcs ~ 34 gr



TRIANGLE
MA1922
96 x 22 h 17 mm - 10 pcs ~ 23 gr

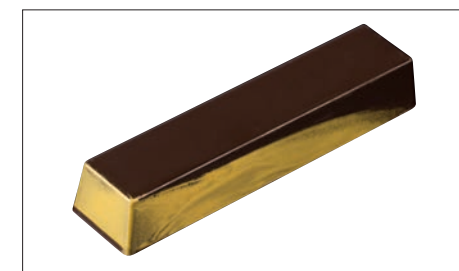

PLAIN
MA1921
96 x 22 h 15,5 mm - 10 pcs ~ 34 gr

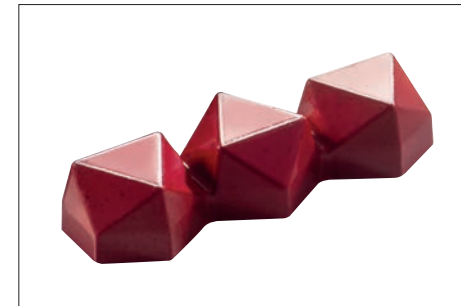

MODERN BON
MA1924
86,6 x 31,6 h 18 mm
Prod. 8 pcs ~ 34,5 gr



CLASSIC BON
MA1926
90 x 30,8 h 16,5 mm
Prod. 8 pcs ~ 30 gr

Polycarbonate moulds 275 x 175 mm

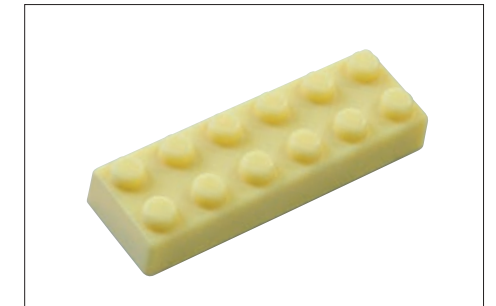

BRICK
MA1918
81 x 27 h 15 mm
Prod. 12 pcs ~ 30 gr



SNACK CITY
MA1919
113 x 39 h 10 mm
Prod. 3 x 2 pcs ~ 45 gr



Polycarbonate moulds 275 x 175 mm

FLAT

MA6100
198x35 h 23 mm
Prod. 4 pcs ~ 160 gr



ROUND

MA6101
198x35 h 23 mm
Prod. 4 pcs ~ 150 gr

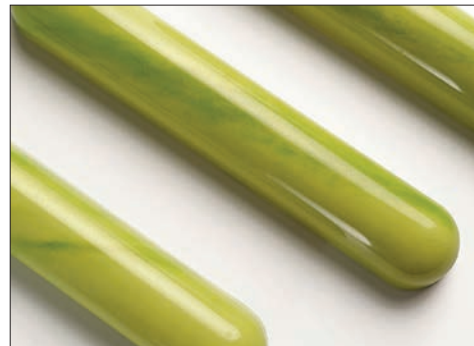

CURVY

MA6102
198x35 h 23 mm
Prod. 4 pcs ~ 150 gr



WAVY

MA6103
198x35 h 23 mm
Prod. 4 pcs ~ 150 gr



Classic Shapes

Polycarbonate moulds 275 x 175 mm

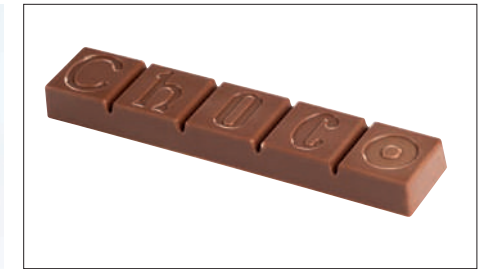

MA1923
120 x 24 h 11 mm - 8 pcs ~ 33 gr



MA1914
100 x 26 h 16 mm - 8 pcs ~ 30 gr



MA1915
123 x 27 h 12 mm - 8 pcs ~ 30 gr



MA1917
115 x 24 h 15 mm - 8 pcs ~ 30 gr



MA1805
58 x 58 h 10 mm - 8 pcs ~ 35 gr



MA1806
119 x 29 h 10 mm - 8 pcs ~ 35 gr

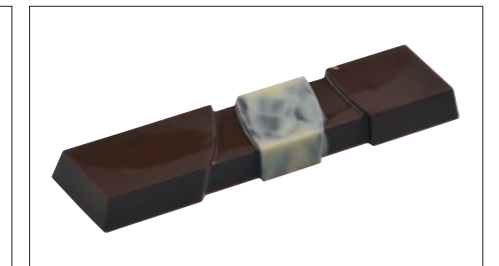

MA1913
119 x 29 h 10 mm - 8 pcs ~ 34 gr



MA1916
100 x 29 h 14 mm - 8 pcs ~ 30 gr



MA1910
99 x 33 h 10 mm - 8 pcs ~ 32 gr



20-D015
129 x h 17 mm - 12 pcs ~ 12 gr

SPECIALS



Napolitains

Polycarbonate moulds 275 x 175 mm



MA6002
42 x 25 h 6 mm - 20 pcs ~ 4 gr



MA6005
45 x 23 h 6 mm - 20 pcs ~ 4 gr



MA2002
32 x 32 h 4 mm - 24 pcs ~ 5 gr



MA6004
42 x 27 h 5 vmm - 20 pcs ~ 4 gr



MA2006
50 x 26 h 3 mm - 16 pcs ~ 5 gr



MA2007
74 x 33 h 5 mm - 12 pcs ~ 13 gr



MA6003
ø 39 h 4,5 mm - 15 pcs ~ 4 gr



MA6006
34 x 34 h 4 mm - 24 pcs ~ 4 gr



MA6001
31 x 31 h 4,5 mm - 24 pcs ~ 4 gr





Circle disk

Polycarbonate moulds 275 x 175 mm



CIRCLE 30

MA1026
Ø 30 h 3 mm
Prod. 24 pcs ~ 2,5 gr



CIRCLE 33

MA1027
Ø 33 h 4 mm
Prod. 24 pcs ~ 4 gr



CIRCLE 40

MA1028
Ø 40 h 4 mm
Prod. 15 pcs ~ 5,5 gr



CIRCLE 75

MA1030
Ø 75 h 5 mm
Prod. 6 pcs ~ 25 gr

MINI Choco Fill

Polycarbonate moulds 275 x 175 mm



20GU001
Ø 32 h 37 mm - Prod. 20 pcs



20GU002
ø 40 h 17 mm - Prod. 15 pcs



20GU003
33 x 31 h 20 mm - Prod. 24 pcs



20GU004
33 x 33 h 23 mm - Prod. 24 pcs



20GU005
32 x 42 h 29 mm - Prod. 24 pcs



20GU006
Ø 27 h 31 mm - Prod. 28 pcs



20GU007
Ø 37 h 14 mm - Prod. 15 pcs



20GU008
27 x 27 h 31 mm - Prod. 28 pcs



20GU009
33 x 33 h 14 mm - Prod. 24 pcs



MA1951
55 x 69 h 34 mm ~ 20 gr - 7 pcs



MA1952
Ø 81 h 8 mm ~ 10 gr - 3 pcs



MA3006
92 x 26 h 7 mm ~ 6 gr - 13 pcs



20GU500
44 x 56 h 39 mm - Prod. 12 pcs



20GU501
Ø 40 h 18,5 mm - Prod. 15 pcs



20GU502
44 x 55 h 23 mm - Prod. 12 pcs



MA1953
47 x 59 h 30 mm ~ 17 gr - 7 pcs



MA1954
Ø 67 h 6,5 mm ~ 9 gr - 5 pcs



SCC01
25 x 95 mm - 1 pc



DECORATIONS





STAMP

Chocolate Decoration Tool

Si arricchisce la gamma di strumenti creati da **Frank Haasnoot** per realizzare facilmente decorazioni in cioccolato. Con i nuovi timbri sarà possibile personalizzare le creazioni con messaggi d'auguri o dando identità agli ingredienti utilizzati.

The range of tools created by **Frank Haasnoot** for easily making chocolate decorations has been expanded. With the new stamps, it will be possible to personalise the creations with messages of good wishes or by giving identity to the ingredients used.



HAPPY BIRTHDAY

20FH30S - Ø 3 cm
20FH30L - Ø 6 cm



VANILLA

20FH33L - Ø 6 cm



COCOA

20FH32L - Ø 6 cm



COFFEE

20FH34 - Ø 6 cm



HAPPY VALENTINE

20FH37S - Ø 3 cm
20FH37L - Ø 6 cm



LOVE

20FH31S - Ø 3 cm
20FH31L - Ø 6 cm



HAPPY EASTER

20FH36S - Ø 3 cm
20FH36L - Ø 6 cm



SANTA

20FH38L - Ø 6 cm



MERRY CHRISTMAS

20FH35L - Ø 6 cm



COMB

Chocolate Decoration Tool

Ideati da **Frank Haasnoot** per creare eleganti **decorazioni in cioccolato**.
Realizzati in acciaio inox, i pettini consentono di produrre numerosi soggetti con un solo movimento.

Designed by **Frank Haasnoot** to create elegant **chocolate decorations**.
Made of stainless steel, the combs allow you to produce many decorations with a single touch.



BUTTERFLY



20FH07S - h 60 mm - prod. 3+3 pcs
20FH07L - h 80 mm - prod. 3+3 pcs

LEAF COMB



20FH01S - h 60 mm - prod. 8 pcs
20FH01L - h 80 mm - prod. 8 pcs

LEAF ECLAIR



20FH04 - h 25 mm - prod. 6 pcs



FEATHER COMB



FEATHER ECLAIR



PETAL COMB



PETAL ECLAIR



20FH02S - h 60 mm - prod. 8 pcs
20FH02L - h 80 mm - prod. 8 pcs



20FH05 - h 25 mm - prod. 6 pcs

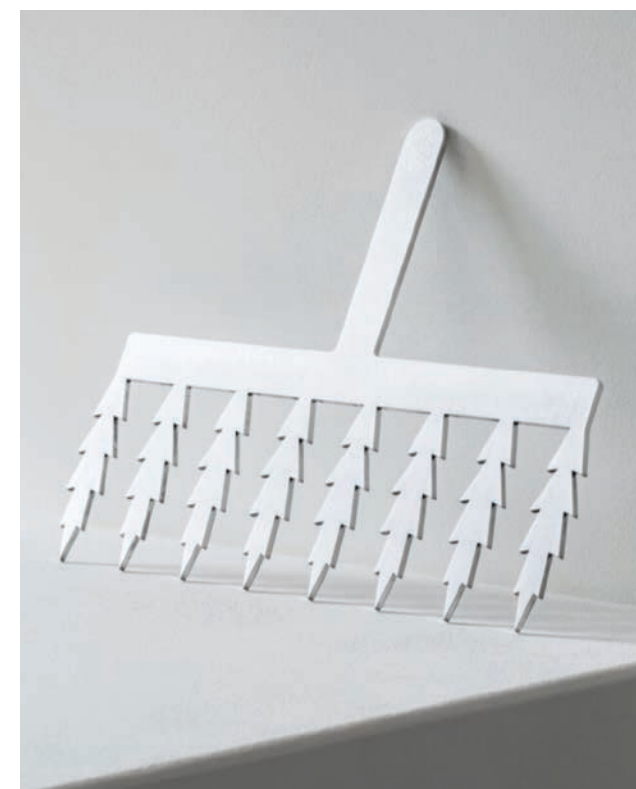

20FH03S - h 60 mm - prod. 8 pcs
20FH03L - h 80 mm - prod. 8 pcs



20FH06 - h 25 mm - prod. 6 pcs

TEMPLATE

Chocolate Decoration Tool

Grazie a questi strumenti, realizzare **decorazioni in cioccolato** non è mai stato così facile.

Perfetti per finire torte e monoporzioni, le **dime in acciaio inox** consentono risultati stupefacenti, anche ai meno esperti.

Thanks to these tools, creating **chocolate decorations** has never been so easy. Perfect for decorating cakes and individual desserts, the **stainless steel templates** allow amazing results, even for the less experienced.

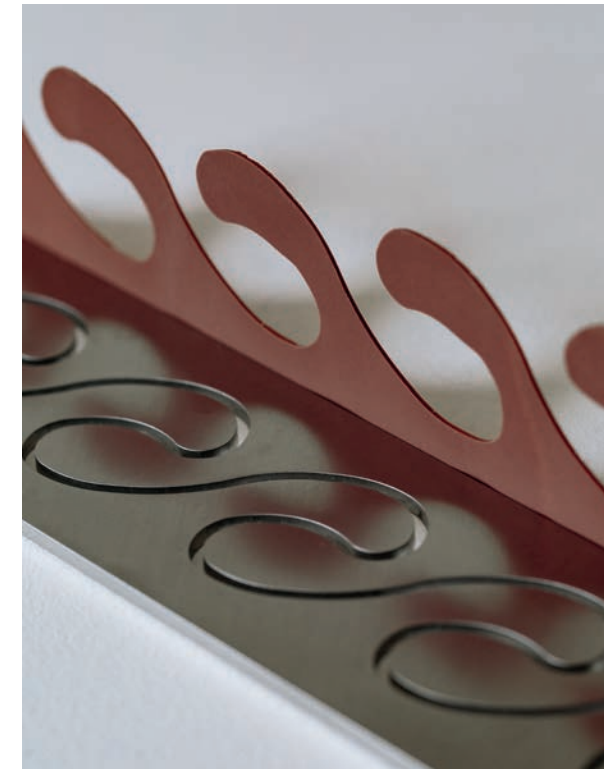

WAVE



DROP



20FH50 - 300 h 55 mm



20FH51 - 300 h 70 mm



ZIGZAG



HEARTBEAT

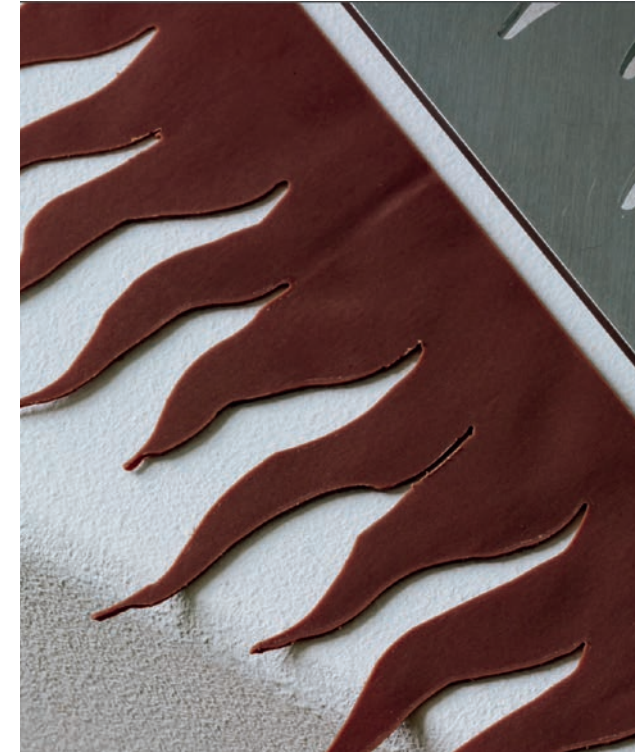

FLAME



20FH54 - 300 h 70 mm



20FH53 - 300 h 85 mm



20FH52 - 300 h 80 mm

Decorations

Polycarbonate moulds 275 x 175 mm



20-D001
63x h 21 mm
18 pcs 2/3 gr



20-D002
66x h 20 mm
18 pcs 2/3 gr



20-D003
64x h 26 mm
16 pcs 2/3 gr



20-D004
63x h 23 mm
18 pcs 2/3 gr



20-D005
72x h 24 mm
18 pcs 2/3 gr



20-D006
72x h 19 mm
18 pcs 2/3 gr



20-D007
66x h 21 mm
18 pcs 2/3 gr



20-D008
65x h 22 mm
18 pcs 2/3 gr



20-D009
70x h 19 mm
18 pcs 2/3 gr



20-D010
50 x h 38 mm
14 pcs 2/3 gr



20-D011
62 x h 31 mm
18 pcs 2/3 gr



20-D012
50 x h 49 mm
12 pcs 2/3 gr



20-D021
73 x 72 54 x 51 35 x 30
mm - 3 x 6 pcs ~ 2 gr



20-D014
ø 50 mm
11 pcs ~ 2 gr

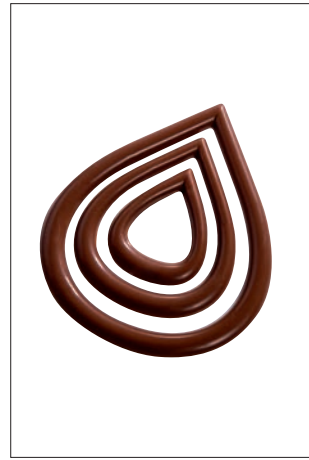

20-D023
66 x 79 46 x 58 28 x 36
mm - 3 x 6 pcs ~ 2 gr



20-D024
70 x 38 mm
12 pcs ~ 2 gr

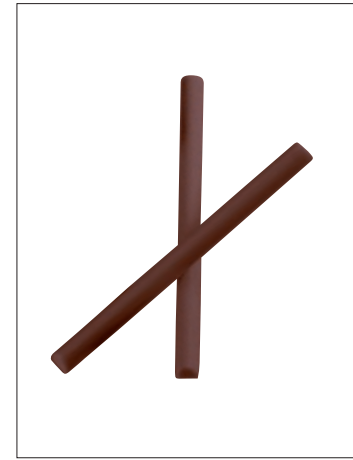

20-D016
Prod. 22 pcs ~ 3/4 gr
110 x h7 mm



20-D017
Prod. 8+8 pcs ~ 2/3 gr
108 x 17 - 101 x 18 mm

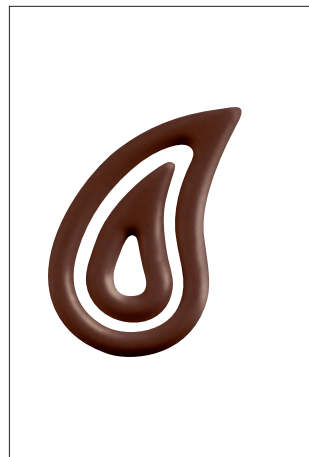

20-D025
73 x 44 50 x 24 mm
10+10 pcs ~ 2/gr

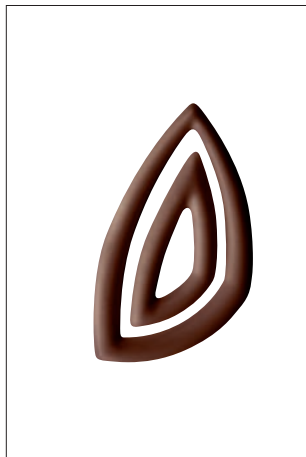

20-D026
41 x 73 20 x 50 mm
10+10 pcs ~ 2 gr



20-D027
38 x 72 33 x 20 mm
6/6+6/6 pcs ~ 2 gr



20-D013
47 x h 39 mm
15 pcs ~ 2 gr



20-D019
Prod. 13+13 pcs ~ 2/3 gr
123 x 4 - 109 x 5 mm

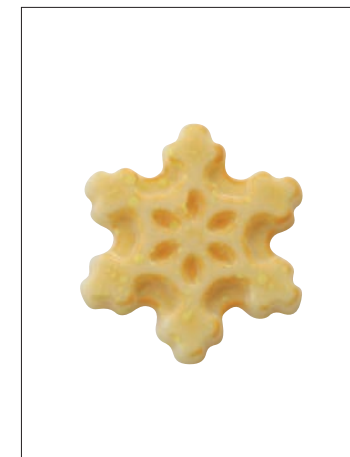

20-D029
14 pcs ø 30 h 4 mm ~ 21 gr
12 pcs ø 40 h 4 mm ~ 2 gr



20-D028
22 pcs mix

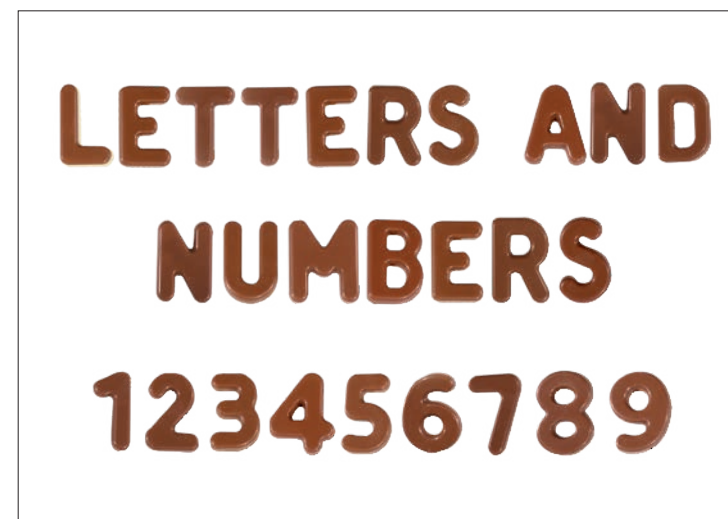

MA3005
letters and numbers h 30 mm

Chablon project

Tappeti in flessibile silicone alimentare per **decorazioni**, con **forme perfette e precise**, pensati per il cioccolato ma adatti anche ad isomalto, caramello, pastigliaggio ed altri impasti che consentiranno di personalizzare la produzione facilmente.

The flexible food silicone mats for **decorations** with **perfect and precise shapes** are designed for chocolate, but work also for isomalt, caramel, pastillage and other doughs in order to easily personalize the production.

Tappeto in silicone 390x290 mm
Spessore 1,5 mm

Silicone mat 390x290 mm
Thickness 1,5 mm



HEARTS CHASIL33



SPOT CHASIL32



FLOWERS
CHASIL34
52x49 mm - 8 pcs
42x40 mm - 8 pcs
33x31 mm - 12 pcs



BUTTERFLIES
CHASIL31
60x44 mm - 8 pcs
54x40 mm - 8 pcs
46x34 mm - 12 pcs



HEARTS
CHASIL33
45x43 mm - 8 pcs
40x39 mm - 8 pcs
35x34 mm - 12 pcs



SQUARE
CHASIL25
60x60 mm - 12 pcs
CHASIL24
37,5x37,5 mm - 30 pcs
CHASIL23
25x25 mm - 63 pcs



OBLONG
CHASIL20
132x32 mm - 10 pcs
CHASIL27
125x25 mm - 18 pcs
CHASIL28
60x18 mm - 36 pcs



ROUND
CHASIL 16
Ø 26 mm - 48 pcs
CHASIL 17
Ø 36 mm - 36 pcs
CHASIL 18
Ø 42 mm - 30 pcs
CHASIL21
Ø 20 mm - 99 pcs
CHASIL26
Ø 62,5 mm - 12 pcs



STAR
CHASIL29
Ø 26 mm - 60 pcs
CHASIL30
Ø 34 mm - 42 pcs



RECTANGULAR
CHASIL19
32x120 mm - 12 pcs



SPOT
CHASIL32
60x63 mm - 16 pcs



LEAF
CHASIL22
75x33 mm - 25 pcs



FANTASY 10
CHASIL 10
97x30 mm - 18 pcs



DROP
CHASIL 1
35x25 mm
60 pcs



LEAF
CHASIL 2
35x33 mm
48 pcs



HEART
CHASIL 3
35x25 mm
48 pcs



PUZZLE
CHASIL 5
50x78 mm
18 pcs



FLOWER
CHASIL 8
55x50 mm
25 pcs

CHOCO LIGHT

Stampi termoformati leggeri ed economici per realizzare soggetti e decorazioni.
Light and economical thermoformed moulds to create subjects and decorations.



90-13040
12 pcs - 35x60 h8



90-13179



2 pcs
55x70 h5



2 pcs
70x88 h5



1 pcs
75x95 h8



90-12816



2 pcs - 50x20
h8



2 pcs - 27x27
h10



2 pcs - 40x35
h10



2 pcs - 53x27
h8



2 pcs - Ø 42 h8



2 pcs - 52x27
h8



2 pcs - 35x40
h8



90-P9645



10 pcs
80x35 h3mm



90-14243



1 pcs
45x40 h5mm



90-P9661



13 pcs
50x25 h3mm



90-P9662



14 pcs
50x25 h3mm



20-1010
Prod. 6 petals
105x50 h 25 mm



20-1011
Prod. 8 petals
80x35 h 18 mm

LOTUS FLOWER

Kit composto da 1 stampo semisfera e 4 stampi petalo.
Kit made up of 1 semisphere mould and 4 petal moulds.



90-13064



2 pcs
Ø 50 h5



2 pcs
Ø 40 h5



2 pcs
Ø 32 h5



2 pcs
55x50 h5



1 pcs
70x40 h5



1 pcs
80x45 h5



1 pcs
55x30 h5



90-1000



1 pcs
210x64 mm



90-15303



12 pcs
42x19 h6mm

3D OBJECTS

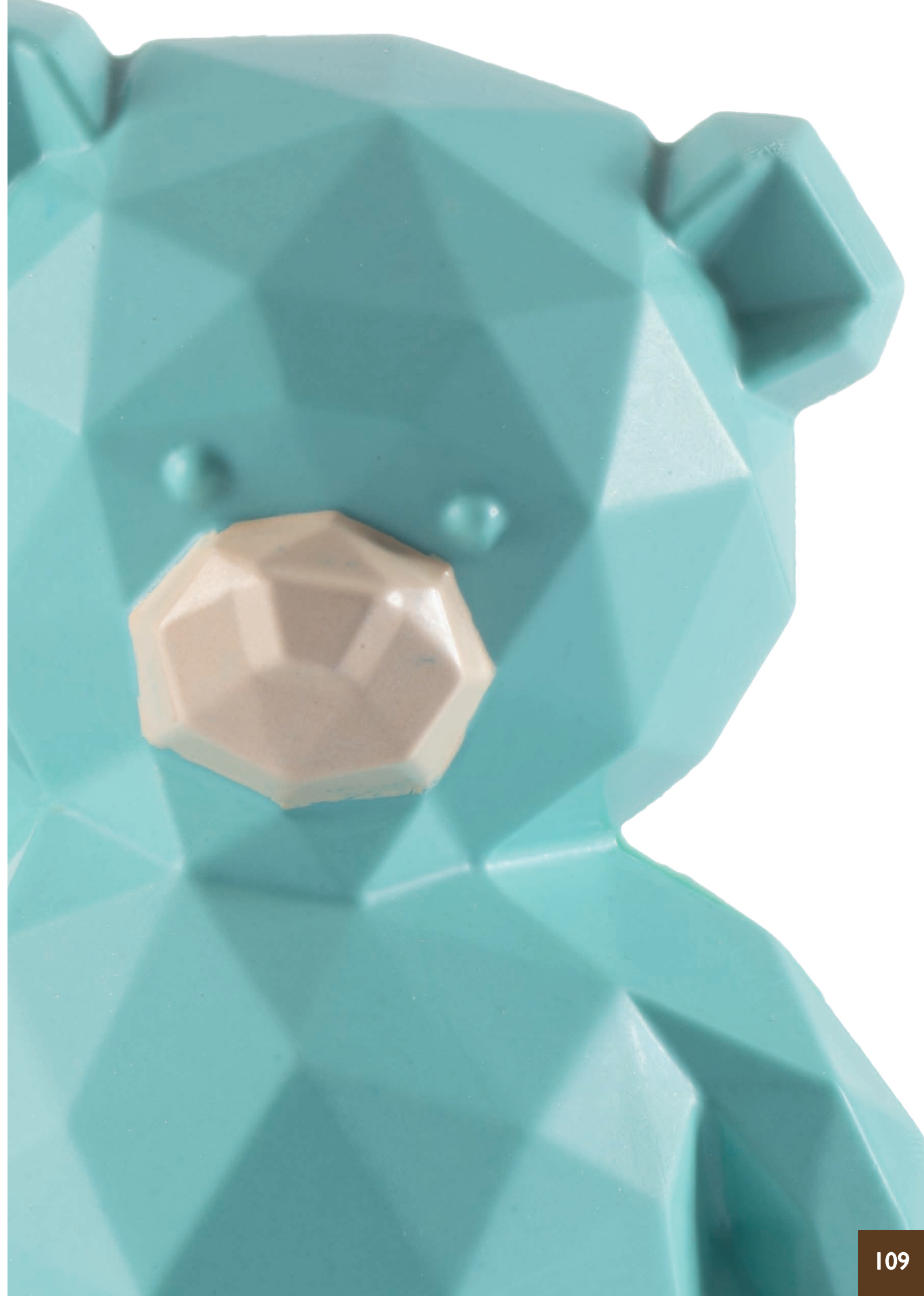



Magnetic 3D



Stampi tematici ad alta produttività in policarbonato con calamite per unire le due metà e realizzare in modo facile e preciso soggetti 3D in cioccolato.

High productivity thematic polycarbonate moulds with magnets to join the two halves and easily and precisely produce 3D chocolate subjects.

Polycarbonate moulds 275 x 175 mm with magnets

HULA TREE

20SR100

ø 110 h 152 mm
Prod. 2 pcs ~ 200 gr



RUDOLPH

20SR101

88 x 56 h 120 mm
Prod. 2 pcs ~ 70 gr

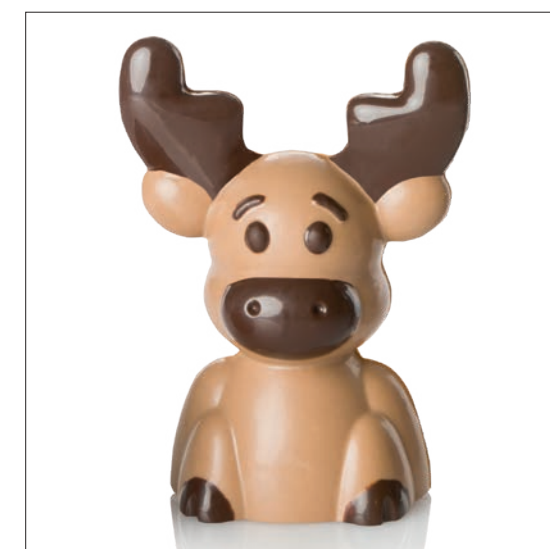

Magnetic 3D

Polycarbonate moulds 275 x 175 mm with magnets



SIR TOY

20SR102

53 x 44 h 120 mm
Prod. 4 pcs ~ 35 gr



DIAMANTINE

20SR103

ø 62 h 72 mm
Prod. 6 pcs ~ 50 gr



Polycarbonate moulds 275 x 175 mm with magnets



CURVY REINDEER

20-C1002

46 x 45 h 100 mm
Prod. 4 pcs ~ 68 gr



REINDEER

20-C1001

43 x 43 h 120 mm
Prod. 4 pcs ~ 65 gr



TREE

20-C1000

Ø 58 h 100 mm
Prod. 5 pcs ~ 100 gr



SANTA & SNOWMAN

20-C1010

Santa Claus: ø 46 h 79 mm
Snowman: 42 x 46 h 72 mm
Prod. 4+4 pcs



Diamond XMAS

Polycarbonate moulds 275 x 175 mm

La tradizione si trasforma in modernità grazie agli stampi in policarbonato per soggetti natalizi in versione diamantata.

Tradition turn into modernity thanks to the polycarbonate molds for Christmas subjects in the diamond version.



TEDDY

MA3014
97 x 64 h 130 mm - Prod. 1 pcs - 110 gr



SANTA

MA3013
68 x 61 h 130 mm - Prod. 2 pcs ~ 120 gr



TREE

MA3012
Ø 104 h 180 mm - Prod. 1 pc ~ 160 gr

XMAS objects

Polycarbonate moulds 275 x 175 mm



SANTA

MA3008
Ø 70 h 120 mm ~ 55 gr
Prod. 2 pcs



TREESMAS

MA3009
Ø 75 h 120 mm ~ 45 gr
Prod. 2 pcs



BOTTLE

MA3010
Ø 65,4 h 220 mm
tappo/closer ø 26,8 mm
120 gr - Prod. 1 pc



SMALL BOTTLE

MA3011
60,2 x 20,6 h 15,8 mm - 12 gr
Prod. 18 pcs



XMAS trees

Thermoformed moulds 275 x 175 mm



MODULAR TREES

20CT01

Ø 150 h 180mm ~290 gr
4 Moulds - Prod. 2 pcs



BIG TREE

20C002

Ø 123 h 205mm
~300gr - Prod. 2 pcs

SMALL TREE

20C001

Ø 83 h 140mm
~140gr - Prod. 4 pcs

Stampi cono in plastica termoformata per realizzare alberi o pièce in cioccolato.

Thermoformed plastic moulds to make Christmas trees or chocolate pièce.

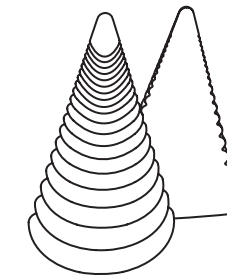

20A3D01

Ø 112 h180 mm
~170gr
4 Moulds
Prod. 2 pcs

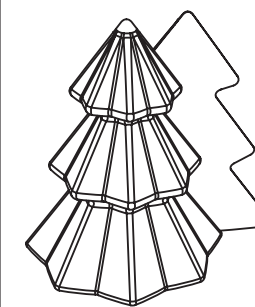

20A3D02

Ø 95 h120 mm
~100gr
4 Moulds
Prod. 4 pcs



SWEET

Christmas

Iconici soggetti 3D che rappresentano una golosa idea regalo da donare in occasione delle feste a parenti ed amici.

Iconic 3D subjects that represent a delicious gift idea to donate to relatives and friends during the holidays.

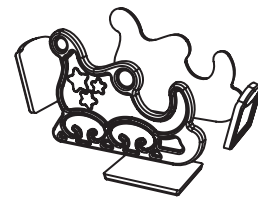

Christmas Sledge
20SL01

Thermoformed plastic
140x70 h 100mm ~140 gr
2 Moulds - Prod. 2 pcs

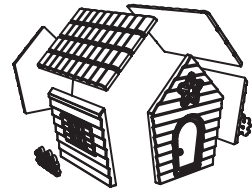

Sweet Home
20HO01

Thermoformed plastic
108x116 h 118mm ~280 gr
4 Moulds - Prod. 2 pcs



Chocolate Gift
20PRO1

Thermoformed plastic
80x80 h 69mm ~80 gr
2 Moulds - Prod. 2 pcs

Chocolate gift
(Praline)

MA1991
Polycarbonate mould
26x26 h 20mm ~11gr
Prod. 28 pcs



Kmas PUZZLE

Thermoformed Plastic Moulds

Pratico kit in plastica termoformata ideale per la creazione veloce di 3 differenti soggetti 2D tematici.

Practical thermoformed plastic kit ideal for the quick creation of 3 different 2D thematic subjects.



20BC100

- 1) 95x9 h 147mm ~80 gr
- 2) 103x9 h 150mm ~80 gr
- 3) 100x9 h 123mm ~80 gr

SEMISPHERES & Decorations

Polycarbonate moulds
275x175 mm



MA5000
24 half spheres
Ø 30mm

MA5003
45 half spheres
Ø 20mm

MA5004
15 half spheres
Ø 40mm

MA5001
8 half spheres
Ø 50mm

MA5005
6 half spheres
Ø 60mm

MA5007
28 half spheres
Ø 25mm

MA5008
15 half spheres
Ø 35mm

MA5009
12 half spheres
Ø 45mm

MA5010
6 half spheres
Ø 55mm

MA5006
4 half spheres
Ø 80mm

MA5002
2 half spheres
Ø 100mm

Thermoformed Moulds



Kit 6 Stampi - Moulds
20SF001

Ø 100 mm - prod 1 pc
Ø 130 mm - prod 1 pc
Ø 140 mm - prod 1 pc
Ø 150 mm - prod 1 pc
Ø 175 mm - prod 1 pc
Ø 200 mm - prod 1 pc

Kit 4 Stampi - Moulds
20SF002

Ø 50 mm - prod 6 pcs
Ø 65 mm - prod 4 pcs
Ø 75 mm - prod 4 pcs
Ø 90 mm - prod 2 pcs

Fiocchi di Neve
Snowflakes



20-D029
Polycarbonate mould
14 pcs Ø 30 h 4mm ~1gr
12 pcs Ø 40 h 4mm ~2gr



XMAS Baubles



20SF003
Ø 60mm ~40 gr



20SF004
Ø 60mm ~40 gr



20SF005
Ø 60mm ~40 gr



20SF006
Ø 60mm ~40 gr



20SF007
Ø 60mm ~39 gr



20SF008
62x69mm ~26 gr



Thermoformed Plastic Moulds
Prod. 6 half baubles each

3D Xmas

Stampi in plastica rigida termoformata completi di molle per realizzare soggetti tematici tridimensionali.
Thermoformed plastic moulds complete with springs to create hollow chocolate figures.

Thermoformed plastic moulds with springs



MAC411S
Princess - 1 pc 72x72 h125mm



MAC407S
Toy Soldier - 1 pc 40x34 h150mm



MAC140S
Santa Claus with fawn - h180mm



MAC409S
Tender bear - 67x54 h105mm ~90gr



MAC408S
Surprise bear - 63x54 h101mm ~90gr



MAC170S
Santa Claus with teddy bear - h168mm



MAC310S
Happy Snowman - h100mm (2 figures)



Snowman
MAC320S - h114mm (3 figures)
MAC321S - h150mm



MAC281S
Santa Claus bear - h180mm



MAC412S
Pandoro - Ø 92 h 85mm ~80 gr



MAC413S
Panettone - Ø 77 h 85mm ~80 gr



Angel with Candle
MAC000S - h80mm (3 figures)
MAC001S - h125mm (2 figures)



MAC421S
Big Boot - h135mm



CHOCO Light

Stampi termoformati per realizzare soggetti e decorazioni di cioccolato.

Thermoformed mould for chocolate figures and decorations.



90-4108



4 pcs
Ø 30 h8



4 pcs
35x25 h8



4 pcs
Ø 35 h8



4 pcs
35x26 h8



90-4109

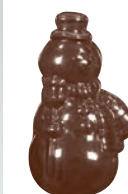

4 pcs
50x30 h6



4 pcs
48x25 h6



4 pcs
48x30 h6



4 pcs
45x30 h6

LET'S PLAY

Thermoformed plastic moulds



Chess Game
20CG01
Ø 25/35 h 40/80 mm
4 Moulds - Prod. 20 mix pcs ~11/36 gr

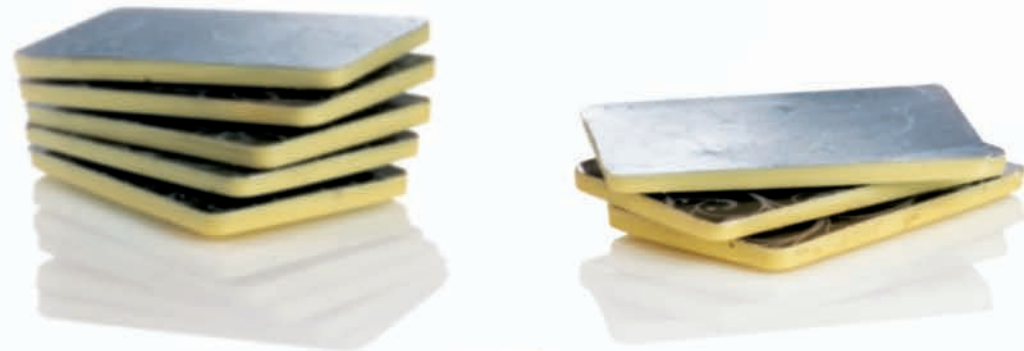

Playing Cards
20PC01
55x90 h 5 mm
4 Moulds - Prod. 16 pcs ~55gr

PER LUI FOR HIM

Thermoformed plastic moulds



Working Tools
20WT01
190x50 / 115x20 mm
4 Moulds - Prod. 20 mix pcs ~20/50 gr

FASHION & STYLE

Thermoformed plastic moulds



Mr Chocolate
200B01
moustache: 117x30 h15 mm
glasses: 140x50 h 10 mm
 1+1 Moulds
 Prod. 4+4 pcs ~22gr



Mr Cigar
20SI01
 125 - Ø 20 mm
 2 Moulds
 Prod. 8 pcs ~40gr

PER LUI FOR HIM

Thermoformed plastic moulds



Soccer Ball
MAC323S
 Ø 120 mm
 1 Thermoformed plastic
 mould with springs



Football Boot
MAC322S
 195x60 h 80 mm
 1 Thermoformed plastic
 mould with springs

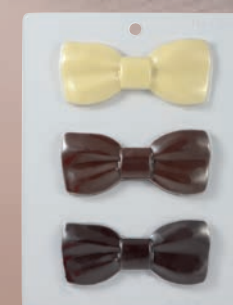

Mr. Papillon
20PP01
 120x52 h13mm
 4 Moulds - Prod. 12 pcs ~55gr



PER LEI FOR HER

FASHION & STYLE



**Eau de Chocolat
20PA01**
Thermoformed plastic
60x31 h92mm ~90gr
4 Moulds - Prod. 4 pcs



**My Sweet Bag
20BA01**
Thermoformed plastic
119x52 h126 ~190gr
2 Moulds - Prod. 2 pcs



**Lady shoe BIG
MAC326S**
Thermoformed plastic
mould with springs
220x85 h165 mm
Prod. 1 pcs ~375 gr



**Lady shoe SMALL
MAC330**
Polycarbonate mould
with magnets
160x70 h120 mm
Prod. 1 pcs ~120 gr



CHOCO MACARON

Stampo in silicone per realizzare splendide praline a forma di macaron.
Silicone mould to create wonderful macaron pralines.



Gusci macaron e vassoio
Macarons shells and tray
30SMT01

prod. 24 gusci / shells
Soggetti/Subjects: Ø 33 h12mm
Vassoio - Tray: 320x195mm
Silicone mould

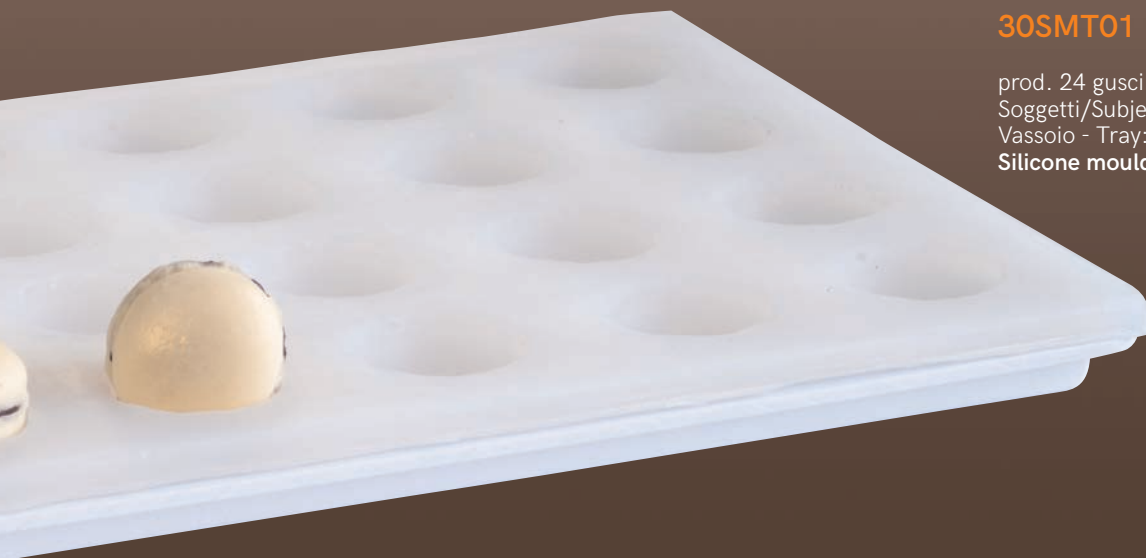

OLD STYLE

Stampi 3D in silicone per realizzare realistici soggetti in cioccolato o isomalto.
3D silicone moulds to create realistic figures in chocolate or isomalt.

Silicone
Idea
sweet creation



Scooter vintage
Vintage scooter
30SM071
80x50 h75mm
Silicone mould

Easter EGGS

Sono in polycarbonato di alta qualità gli stampi per Uova in cioccolato proposti per la prossima Pasqua. Che sia il modello Happy Easter o l'uovo Crack, il risultato è un prodotto di grande effetto realizzabile facilmente.

The moulds for chocolate eggs of this Easter are made of high quality polycarbonate. Whether it is the Happy Easter model or the Crack egg, the result is a product of great effect made easily.

Polycarbonate moulds with magnets 275 x 175 mm

Polycarbonate moulds 275 x 175 mm with magnets



Decorated by
Nicolas Nikolakopoulos



HAPPY EASTER

20SR022

ø 156 x h 228 mm

Prod. 1 pcs ~ 330 gr

per la base è stato usato lo stampo 20-CU001
mould 20-CU001 was used for the base



Easter EGGS

Polycarbonate moulds 275 x 175 mm with magnets



CRACK

20SR021

ø 100 x h 150 mm

Prod. 2 pcs ~ 160 gr

per la base è stato usato lo stampo 20-CU001
mould 20-CU001 was used for the base

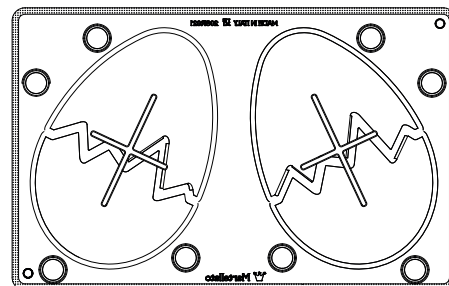

Polycarbonate moulds 275 x 175 mm with magnets



Decorated by
Nicolas Nikolakopoulos



SUAVE

20SR020

ø 113 x h 150 mm

Prod. 2 pcs ~ 220 gr

per la base è stato usato lo stampo 20-CU001
mould 20-CU001 was used for the base

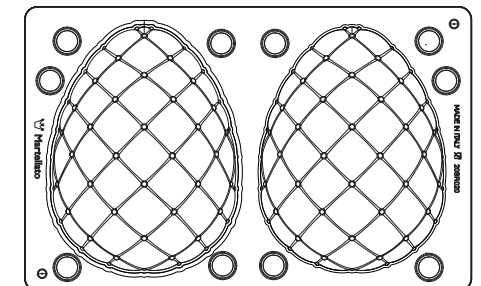

Easter
EGGS

Polycarbonate moulds 275 x 175 mm

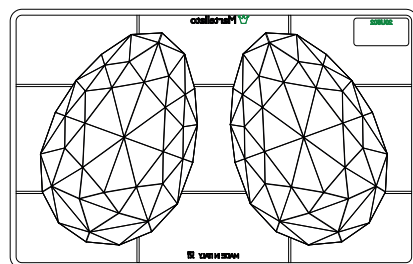

DIAMOND

20U502
Ø 99 h 150 mm
Prod. 1 pc ~ 210 gr
base non inclusa / base not included

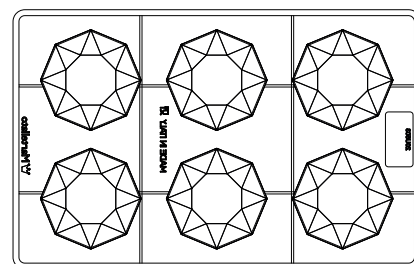

BASE

20U503
68 x 68 h 5,5 mm
Prod. 6 pcs ~ 16 gr

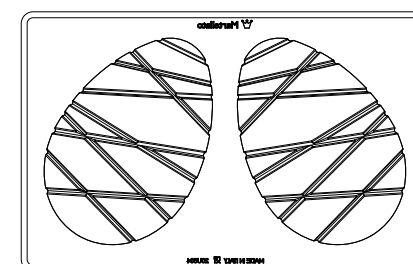

BOND

20U504
Ø 101 h 150 mm
Prod. 1 pc ~ 210 gr
base non inclusa / base not included

Easter EGGS

Polycarbonate moulds 275 x 175 mm

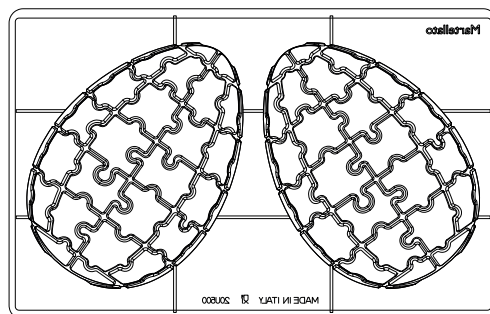

PUZZLE

20U500
 ø 105 h 150 mm
 Prod. 1 pc ~ 210 gr
 base non inclusa / base not included

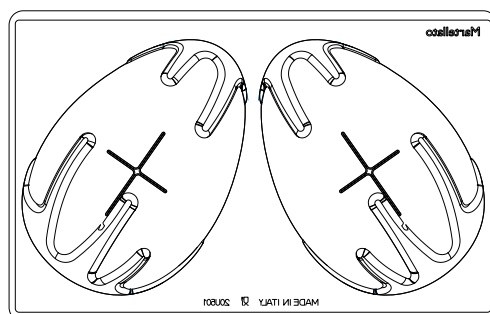
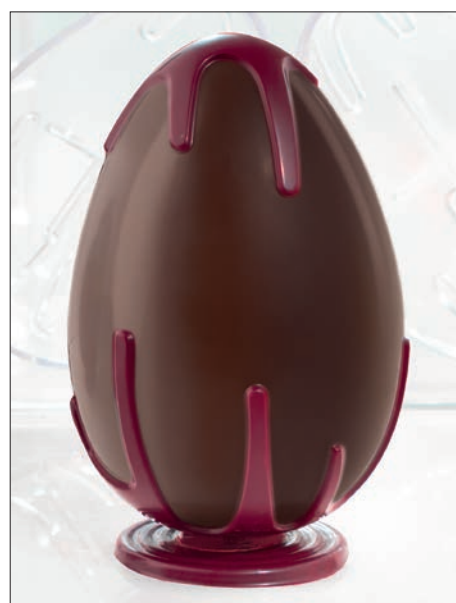

DRIP

20U501
 ø 100 h 150 mm
 Prod. 1 pc ~ 210 gr
 base non inclusa / base not included

Easter EGGS

Thermoformed moulds

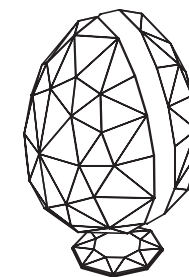

DIAMOND

20U3D07
 Thermoformed plastic
 Ø 120 h 185 mm
 Prod. 2 pcs ~ 280 gr
 base inclusa / base included



GLOBE

20U3D08
 Thermoformed plastic
 Ø 125 h 185 mm
 Prod. 2 pcs ~ 280 gr
 base inclusa / base included

Easter
EGGS

Thermoformed moulds

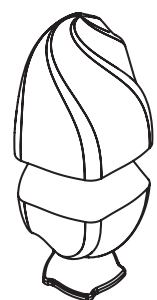

WAVE

20U3D02

Ø 115 h 185 mm
Prod. 2 pcs ~ 320 gr
base inclusa / base included

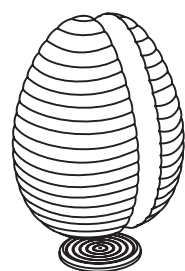

HONEY

20U3D04

Ø 122 h 185 mm
Prod. 2 pcs ~ 270 gr
base inclusa / base included

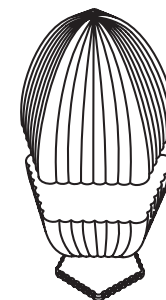

PENTA

20U3D03

Ø 120 h 185 mm
Prod. 2 pcs ~ 300 gr
base inclusa / base included



CURVY

20U3D05

Ø 115 h 185 mm
Prod. 2 pcs ~ 310 gr
base inclusa / base included

Easter EGGS

Thermoformed moulds

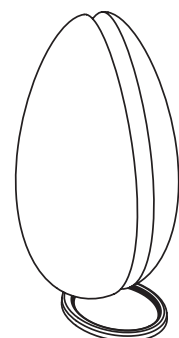

STRETCH

20U3D01
Ø 110 h 220 mm
Prod. 2 pcs ~ 230 gr
base inclusa / base included

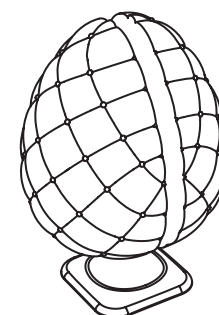

CAPITONNÉ

20U3D06
Ø 115 h 155 mm
Prod. 2 pcs ~ 230 gr
base inclusa / base included



UOVA LISCE / SMOOTH EGGS

Polycarbonate moulds with magnets 275 x 175 mm

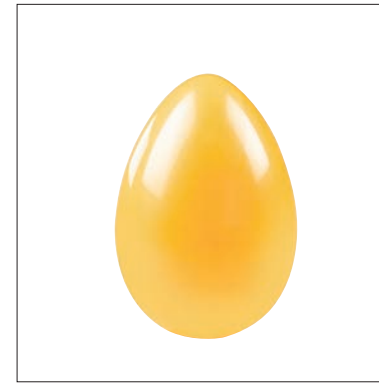

EGG 15

20SR001
 ø 104 h 150 mm
 Prod. 2 pcs ~ 230 gr
 base non inclusa / base not included

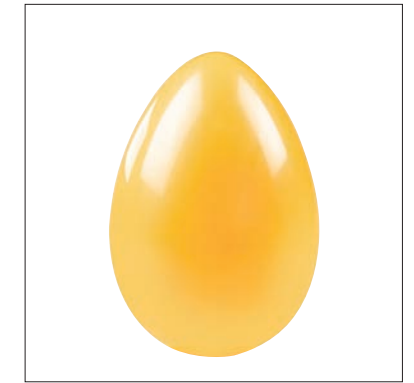

EGG 17

20SR003
 ø 120 h 175 mm
 Prod. 1 pcs ~ 260 gr
 base non inclusa / base not included



EGG 20

20SR002
 ø 141 x h 204 mm
 Prod. 1 pcs ~ 380 gr
 base non inclusa / base not included

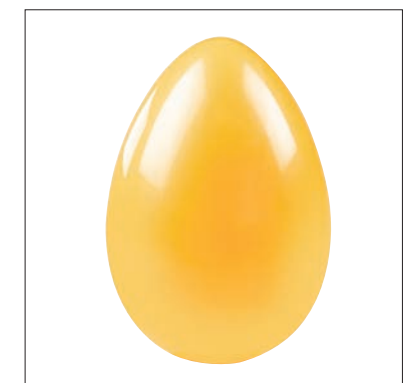

EGG 23

20SR004
 ø 160 h 230 mm
 Prod. 1 pcs ~ 430 gr
 base non inclusa / base not included

UOVA LISCE / SMOOTH EGGS

Polycarbonate moulds 275 x 175 mm
base non inclusa / base not included



Created by
Maurizio Frau

7gr

20U032N
22 x 32 mm
Prod. 16 uova/egg
Peso uovo senza camicia/egg weight
without shell ~ 9 gr

25gr

20U064N
44 x 64 mm
Prod. 5 uova/egg
Peso uovo/egg weight ~ 30 gr
Spessore camicia/shell thickness: 3 mm

70gr

20U105N
72 x 105 mm
Prod. 2 uova/egg
Peso uovo/egg weight ~ 50 gr
Spessore camicia/shell thickness: 3,5 mm

150gr

20U130N
90 x 130 mm
Prod. 1 uovo/egg
Peso uovo/egg weight ~ 100 gr
Spessore camicia/shell thickness: 3,5 mm

230gr

20U150N
104 x 150 mm
Prod. 1 uovo/egg
Peso uovo/egg weight ~ 150 gr
Spessore camicia/shell thickness: 3,5 mm

260gr

20U175N
121 x 175 mm
Prod. 1 mezzo/half
Peso uovo intero/complete egg weight ~ 230 gr
Spessore camicia/shell thickness: 3,5 mm

380gr

20U204N
141 x 204 mm
Prod. 1 mezzo/half
Peso uovo intero/complete egg weight ~ 320 gr
Spessore camicia/shell thickness: 4 mm

430gr

20U227N
157 x 227 mm
Prod. 1 mezzo/half
Peso uovo intero/complete egg weight ~ 450 gr
Spessore camicia/shell thickness: 4 mm

Polycarbonate mould
200 x 365 h 22 mm

500gr

20U258
258 x 175 mm
Prod. 1 mezzi/half
Peso uovo intero/complete egg weight ~ 540 gr
Spessore camicia/shell thickness: 4 mm

Polycarbonate mould
275 x 365 h 22 mm

850gr

20U320
320 x 210 mm
Prod. 1 mezzi/half
Peso uovo intero/complete egg weight ~ 630 gr
Spessore camicia/shell thickness: 4 mm



Light Half EGGS

UOVA LISCE / SMOOTH EGGS

Stampo in plastica termoformata. Base non inclusa.
Thermoformed plastic mould. Base not included.



90-2026

25 x 35 h 12 mm
18 pcs



90-2008

36 x 23 h 12 mm
18 pcs



90-2010

40 x 31 h 17 mm
14 pcs



SM 1000

80 x 60 h 25 mm
4 pcs



SM 2000

110 x 80 h 40 mm
2 pcs



SM 3000

140 x 100 h 50 mm
2pcs



SM 2300

112 x 83 h 44 mm
1 pc x 2 moulds



SM 4000

220 x 160 h 85 mm
1 pcs

SM 2500

125 x 94 h 44 mm
2pcs

SM 3500

154 x 110 h 55 mm
2pcs

Stampo in plastica rigida. Base non inclusa.
Rigid plastic mould. Base not included.

~Kg	Misure mm	Code
0,5 - 1	250 x 170	SUT25X17
0,8 - 1,2	280 x 185	SUT28X18
1,5 - 2	325 x 240	SUT34X25
2 - 2,5	390 x 265	SUT40X27
2,5 - 3,5	435 x 310	SUT45X32
4 - 6	520 x 350	SUT54X36
6 - 8	620 x 420	SUT64X43
8 - 10	740 x 490	SUT75X50



Stampo in plastica termoformata per la realizzazione di uova di cioccolato. Base non inclusa.
 Thermoformed plastic mould to realize chocolate eggs. Base not included.

CRACK HALF EGG



90-2009
 39 x 25 h 13 mm
 14 pcs



90-2353
 64 x 44 h 26 mm
 6 pcs



90-2354
 83 x 54 h 24 mm
 4 pcs



2 moulds
90-2355
 96 x 70 h 40 mm
 2 pcs



2 moulds
90-2356
 140 x 100 h 49 mm
 1 pcs



EGGS HOLDERS

Per realizzare supporti di cioccolato
 To create chocolate holders



20-CU001
 Set 3 thermoformed moulds
 36,5 x 36,5 h 9 mm - 12 pcs
 40,5 x 40,5 h 12 mm - 9 pcs
 52,7 x 52,7 h 12 mm - 6 pcs

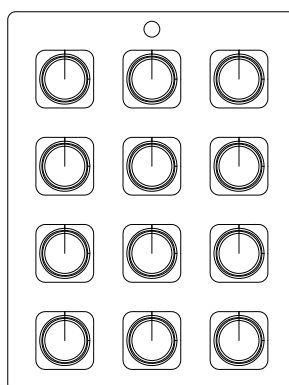

Stampo in plastica termoformata.
 Thermoformed plastic mould.



20-U1010
 h 110 mm ~100 gr
 Thermoformed mould



20-U1011
 h 80 mm ~250 gr
 Thermoformed mould

PUZZLE EGGS



20UB100 Thermoformed plastic

Pack 3 models

- 1) 107 x 82 h 158 mm ~160 gr
 - 2) 110 x 58 h 165 mm ~160 gr
 - 3) 104 x 52 h 150 mm ~140 gr
- base inclusa / base included

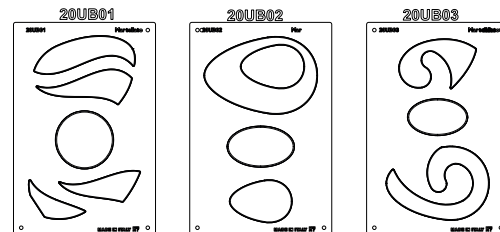

Origami Easter



20OR001 Thermoformed plastic

Pack 3 models

- Chick: 113 x 42 h 132 mm ~100 gr
 - Sheep: 100 x 45 h 100 mm ~90 gr
 - Bunny: 76 x 42 h 142 mm ~60 gr
- base inclusa / base included

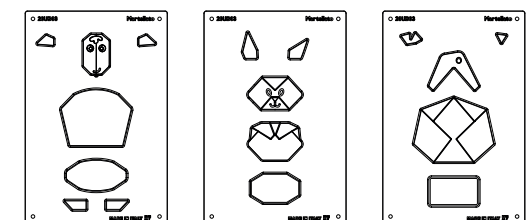

Easter objects

Polycarbonate mould 275 x 175 mm

Polycarbonate moulds with magnets 275 x 175 mm



ROGER

MA3016
78 x 73 x h 150 mm
Prod. 1 pcs ~ 130 gr

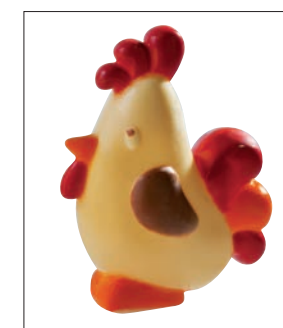

ROOSTER

20-C1955
100 x 160 h 126 mm
~ 80 gr - Prod.2 pcs



HEN

20-C1956
94 x 108 h 106 mm
~ 75 gr - Prod.4 pcs



CHICK

20-C1957
65 x 84 h 80 mm
~ 45 gr - Prod.6 pcs

CHOCO

3D

Stampi in plastica termoformata con molle per soggetti di cioccolato con corpo cavo.
Thermoformed plastic mould with springs for chocolate figures.



SHEEP

MAC603S
140 x 120 h 190mm
~310 gr



CHICK

MAC602S
160 x 120 h 210mm
~460 gr



RABBIT

MAC604S
120 x 120 h 220mm
~480 gr



CHICKEN

MAC612S
70 x 70 h 130mm
~110 gr



DUCK

MAC611S
70 x 70 h 120mm
~110 gr



LITTLE BUNNY

MAC614S
Ø 60 h 140mm
~85 gr



BUNNY

MAC613S
Ø 80 h 120mm
~110 gr



MS COCODÉ

MAC615S
108 x 75 h 120 mm
~90 gr

MR. BUNNY

MAC616S
90 x 60 h 152 mm
~100 gr



Stampi in plastica rigida termoformata con molle per realizzare soggetti tridimensionali.
Thermoformed plastic mould with springs to easily realize hollow chocolate figures.



NICE CHICKEN
MAC800S
h 160 mm (2 figures)
MAC801S
h 205 mm



SMALL CHICKEN
MAC822S
h 110 mm
MAC823S
h 160 mm



BABY CHICK
MAC870S
h 110 mm (3 figures)



BABY GOOSE
MAC880S
h 145 mm



SMALL BELL
MAC950S
h 110 mm



BUNNY
MAC661S
h 140 mm



BABY BUNNY
MAC620S
h 180 mm



HUG IN EGG
MAC720S
h 170 mm (2 figures)



BUNNY IN LOVE
MAC630S
h 235 mm

ANIMATED EGGS

Kit stampi componenti in **plastica termoformata** per realizzare soggetti 3D
Thermoformed plastic components mould kit to realize 3D objects

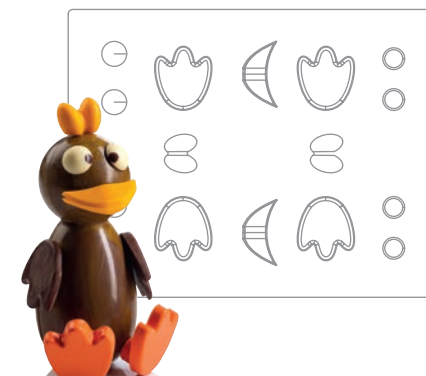
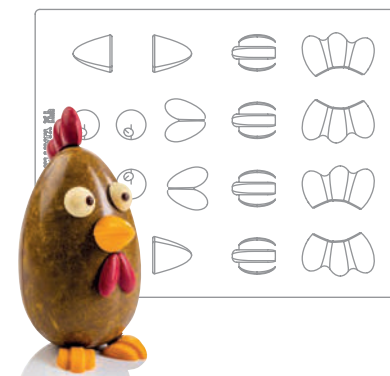

20SC01

Pack 3 pezzi per soggetti differenti. Non inclusi uova e sfere per corpo.
Pack 3 pcs for different figures. Eggs and sphere for body not included.

CHOCO *Light*

Stampi in **plastica termoformata** per realizzare soggetti e decorazioni di cioccolato.
Thermoformed plastic moulds to create chocolate figures and decorations.



90-2102



3 pcs
43x40 h12



4 pcs
40x35 h11



4 pcs
40x35 h17



3 pcs
48x35 h8



90-2316
79x58h12 mm
2 pcs



90-2346
150x64h25 mm
1 pcs



Halloween figures

Stampi in plastica termoformata con molle
per soggetti di cioccolato con corpo cavo.
Thermoformed plastic mould with springs
for chocolate figures.



BIG 3D PUMPKIN
MAC325S
140 x 140 h 150 mm



SMALL 3D PUMPKIN
MAC324S
52 x 54 h 132 mm ~ 140 gr

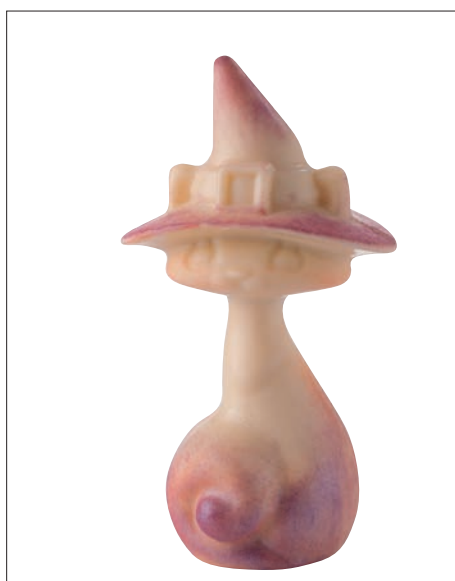

BLACK CAT
MAC405S
57 x 39 x h 102 mm ~ 50 gr



MR PUMPKIN
MAC406S
39 x 42 x h 102 mm ~ 40 gr



PERFORMANCE

designed for Chocolate Machines

PERFORMANCE, diverse tipologie di stampi, tutte con un denominatore comune: elevate performance produttive ottenute grazie all'interazione con le macchine per il cioccolato.

Stampi in policarbonato con caratteristiche che li rendono adatti a tutte le macchine presenti sul mercato e consentono un automatismo produttivo, pur mantenendo l'esclusività della produzione artigianale.

Performance comprende le linee One Shot, per macchine dosatrici, e la linea Spinning, per macchine rotative.

PERFORMANCE, different moulds types, all with a common denominator: high production performance achieved through interaction with chocolate machines. Polycarbonate moulds with features that make them suitable for all machines on the market and provide production automation, while maintaining the exclusivity of artisan production.

Performance includes the One Shot line, for dosing machines, and the Spinning line, for rotating machines.

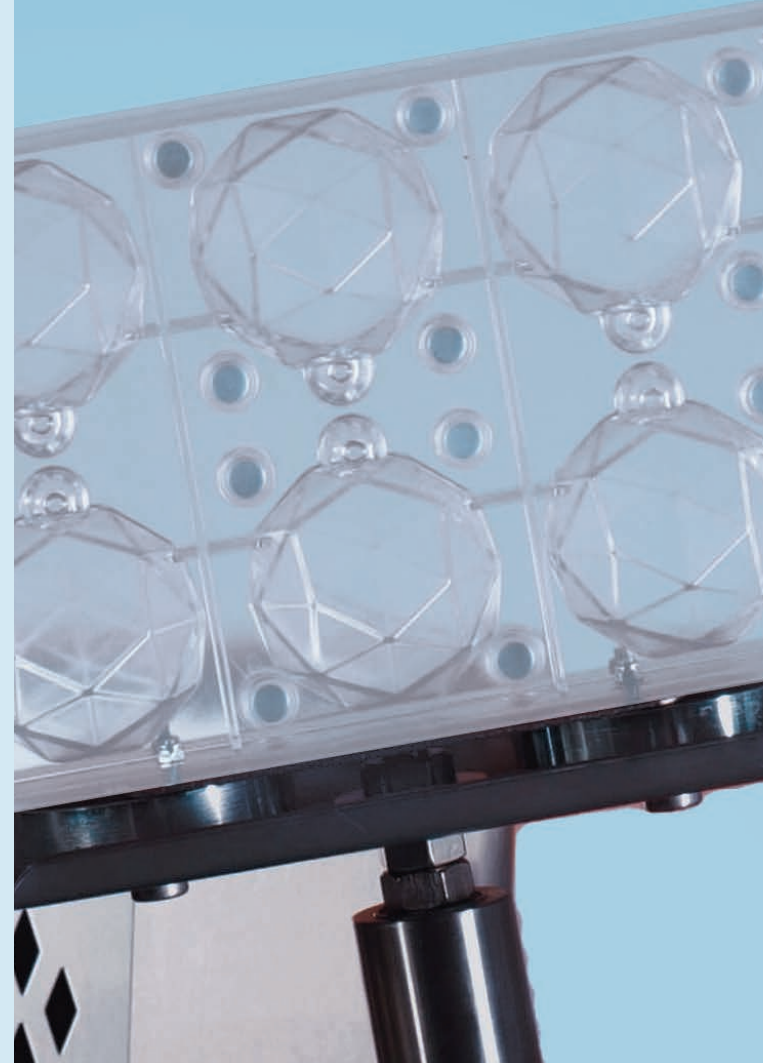

Stampi per soggetti adatti all'uso sulle macchine rotative.

Moulds for subjects suitable for use on rotating machines.

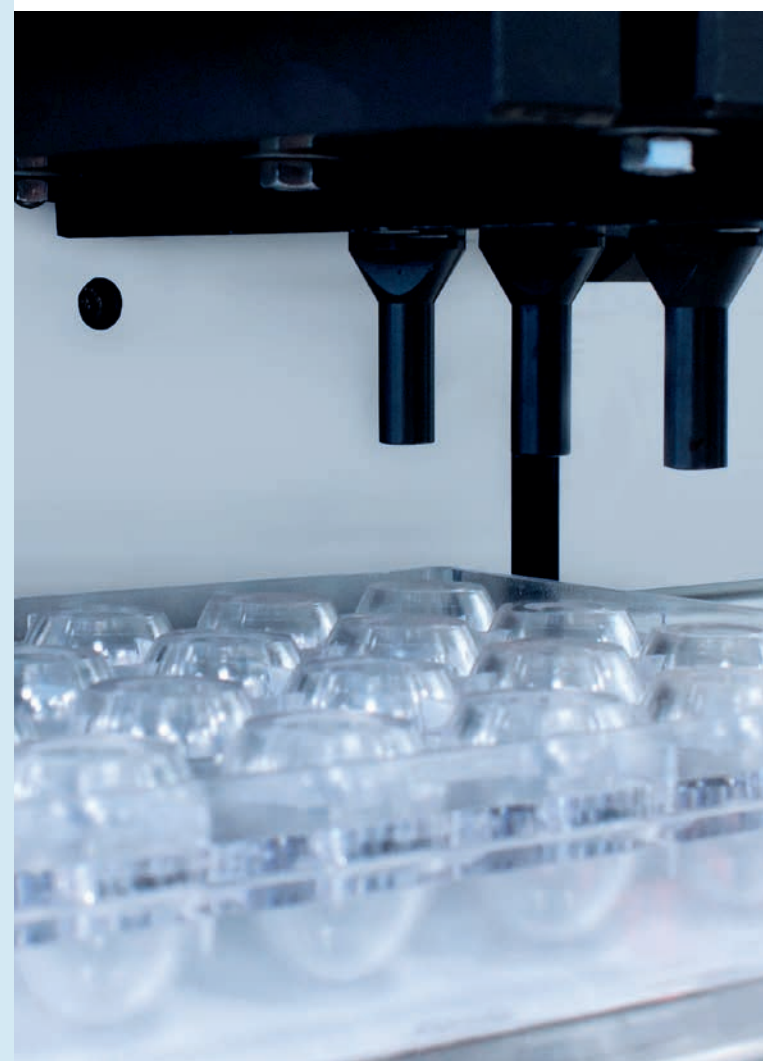

[ONE SHOT]

Stampi per praline adatti all'uso con macchine dosatrici OneShot.

Moulds for pralines suitable for use with OneShot dosing machines.



[ONE SHOT] PER DOSATRICI SIMULTANEE
FOR SIMULTANEOUS DISPENSING MACHINE

Polycarbonate moulds with magnets 275 x 175 mm



TRUFFLE

203D01
Ø 26 h 24 mm
Prod. 28 pcs ~ 10 gr



TRUFFLE 2

203D02
Ø 23 h 20,6 mm
Prod. 28 pcs ~ 7 gr



HEART

203D03
30 x 28 h 19 mm
Prod. 28 pcs ~ 11 gr

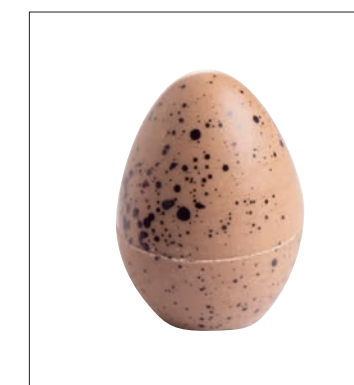

EGG

203D04
Ø 23,5 h 32 mm
Prod. 28 pcs ~ 10 gr

Stampi per praline adatti all'uso con macchine dosatrici OneShot.

Moulds for pralines suitable for use with OneShot dosing machines.

Caratteristiche tecniche/Technical features



Chiusura con magneti
Magnetic closure



Pioli di centraggio
Centring pegs



Sistema di incastro
Interlocking system



SPINNING
 MOULD

PER MACCHINE ROTATIVE
 FOR ROTATING MACHINE

Polycarbonate moulds with magnets 275 x 175 mm



20SR001A
 ø 104 h 150 mm
 Prod. 2 pcs ~ 230 gr
 base non inclusa / base not included



20SR003A
 ø 120 h 175 mm
 Prod. 1 pcs ~ 260 gr
 base non inclusa / base not included

Stampi per soggetti adatti all'uso sulle macchine rotative.

Moulds for subjects suitable for use on rotating machines.

Caratteristiche tecniche/Technical features

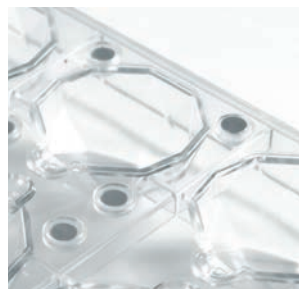

Chiusura con magneti
 Magnetic closure



Pioli di centraggio
 Centring pegs



Placca di metallo
 Metal plate



20SR002A
 ø 141 x h 204 mm
 Prod. 1 pcs ~ 380 gr
 base non inclusa / base not included



20SR004A
 ø 160 h 230 mm
 Prod. 1 pcs ~ 430 gr
 base non inclusa / base not included

Polycarbonate moulds with magnets 275 x 175 mm

HAPPY EASTER

20SR022A

ø 156 x h 228 mm - Prod. 1 pcs ~ 330 gr
base non inclusa / base not included



CRACK

20SR021A

ø 100 x h 150 mm - Prod. 2 pcs ~ 160 gr
base non inclusa / base not included



SUAVE

20SR020A

ø 113 x h 150 mm - Prod. 2 pcs ~ 220 gr
base non inclusa / base not included





Polycarbonate moulds with
magnets 275 x 175 mm

TREE

20SR100A

ø 110 x h 152 mm
Prod. 2 pcs ~ 200 gr



Polycarbonate moulds with magnets 275 x 175 mm

REINDEER

20SR101A

88 x 56 h 120 mm
Prod. 2 pcs ~ 70 gr



TOY

20SR102A

53 x 44 h 120 mm
Prod. 4 pcs ~ 65 gr



DIAMOND BALL

20SR103A

ø 62 h 72 mm
Prod. 6 pcs ~ 50 gr



Wedding Time

Tappeti e stampi 3D in silicone per realizzare topper e piece in **cioccolato** o **isomalto** che serviranno a decorare wedding cake o altre creazioni.

Mats and 3D silicone moulds to prepare **chocolate** or **isomalt** toppers and pieces that will be used to decorate wedding cakes or other creations.



WEDDING MAT 2

30SMTP02

210x85 h 250mm

Spessore - Thickness: 9mm

Tappeto - Mat: 300x400mm



WEDDING MAT 3

30SMTP03

250x85 h 285 mm

Spessore - Thickness: 9mm

Tappeto - Mat: 300x400mm



WEDDING MAT 1

30SMTP01

260x85 h 310mm

Spessore - Thickness: 9mm

Tappeto - Mat: 300x400mm

vassoio di sostegno in plastica bianca
white plastic support tray

Silicone
Idea
sweet creation

New Born

Tappeti e stampi 3D in silicone per realizzare topper e piece in **cioccolato** o **isomalto** che serviranno a decorare torte o creare originali bomboniere.

Mats and 3D silicone moulds to prepare **chocolate** or **isomalt** toppers and pieces ideal to decorate cakes or realize original party favours.



30SMTP04
Misure - Size: 300x400mm
Spessore - Thickness: 9mm

Tappeti in silicone per realizzare topper e decorazioni.
Silicone mat to produce toppers and decorations.

Holy Sacraments

Tappeti e stampi 3D in silicone per realizzare topper e piece in **cioccolato** o **isomalto** che serviranno a decorare torte o creare originali bomboniere.

Mats and 3D silicone moulds to prepare **chocolate** or **isomalt** toppers and pieces ideal to decorate cakes or realize original party favours.



COMMUNION AND CONFIRMATION
30SMTP05
Misure - Size: 300x400mm
Spessore - Thickness: 9mm

LOLLIPOP *Mania*

Love

Thermoformed plastic



20L004
Thermoformed plastic
68x65 h9 mm ~ 34 gr
Prod. 8 pcs



Silicone

30SML003
Silicone mould
Tray included: 395x143mm
Prod. 5 pcs

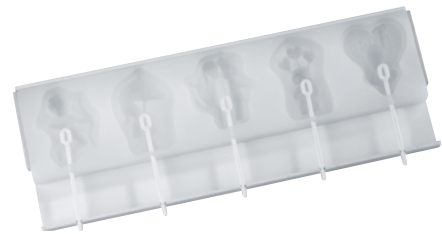

Cupido
Cupid
65x80mm

Innamorati
Loving couple
73x80mm

Bambina
Girl
65x85mm

Innamorato
Boy in love
60x85mm

Innamorata
Girl in love
70x80mm

Halloween

Thermoformed plastic



Pumpkin & Skull Lollipops
20L006
Thermoformed plastic
Prod. 8 pcs
Zucca - Pumpkin:
69x70 h9 mm ~ 33gr - 4 pcs
Teschio - Skull:
53x70 h9 mm ~ 32gr - 4 pcs



Xmas

Thermoformed plastic

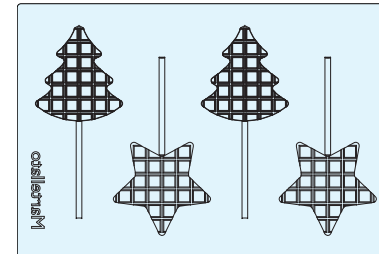

Chocolate lollipop moulds
20L005
Thermoformed plastic - Prod. 8 pcs
Albero - Tree: 70x76 h9 mm ~34 gr
Stella - Star: 77x74 h9 mm ~31 gr



Silicone



70x80mm

75x85mm

70x85mm

80x80mm

60x85mm

Chocolate lollipop moulds
30SML002
Silicone mould - Prod.5 pcs
Tray included: 395x143mm



Chocolate lollipop moulds
20-C024
Rigid plastic mould -
Prod.6 pcs
60x70 mm ~30gr

Choco à porter

Thermoformed plastic

Funzionali e leggeri stampi in plastica termoformata, consentono di creare golosi lollipops per le merende dei più piccoli o i break dei giovani di ogni età.

Functional and lightweight thermoformed plastic moulds, they allow you to create delicious lollipops for snacks of children or breaks for young people of all ages.

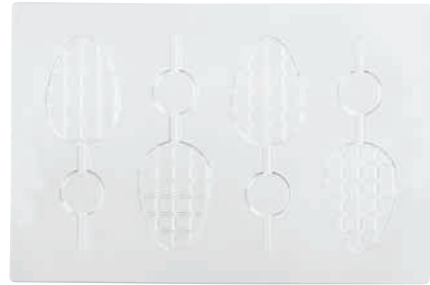

Ovale liscio
Smooth Oval
20L008
5+5 pcs ~22 gr
43x57 h 9 mm

Tondo liscio
Smooth Rounded
20L007
5+5 pcs ~25 gr
Ø 50 h 9 mm

Tondo tavoletta
Round bar
20L002
8 pcs ~30 gr
Ø 60 h 9 mm

Rettangolare tavoletta
Rectangular bar
20L003
8 pcs ~30 gr
50x75 h 9 mm

Uovo tavoletta
Egg bar
20L001
8 pcs ~30 gr
52x77 h 9 mm



PLEXIGLASS DISPLAYS



EL101
Cap. 56 pcs
345x280 h40 mm



EL306
Satinato - Satin
Cap. 30 pcs
295x70 h125 mm



29003
Cap. 20 lollipop
270x180 h 145mm



EL201
Cap. 66 pcs
450x240 h145 mm

ACCESSORIES

Sacchetti per lollipops
Bags for lollipops



20S004
80x120 mm
200 pcs

20S005
90x130 mm
200 pcs

CHOCO TOOLS



CHOCO TOOLS

Forchette in filo di acciaio inox con manico in plastica.
Stainless steel wire forks with plastic handle.

Single fork - Pack 25 pcs

Tipo Type	Codice Code
1	50CHOC01
2	50CHOC02
3	50CHOC03
4	50CHOC04
5	50CHOC05
6	50CHOC06
7	50CHOC07
8	50CHOC08
9	50CHOC09
10	50CHOC010



Kit assortito - Mixed set 10 pcs

CHOCOFORK

1 forchetta per tipo - 1 fork each type

Texture decoro per cioccolato Artisan decor sheets

MACLO1

Pack 13 pcs - 360x340 mm

Kit fogli in plastica trasparente per la realizzazione di praline artigianali e decorazioni di cioccolato.

Transparent plastic sheets kit for handmade pralines and chocolate decorations.

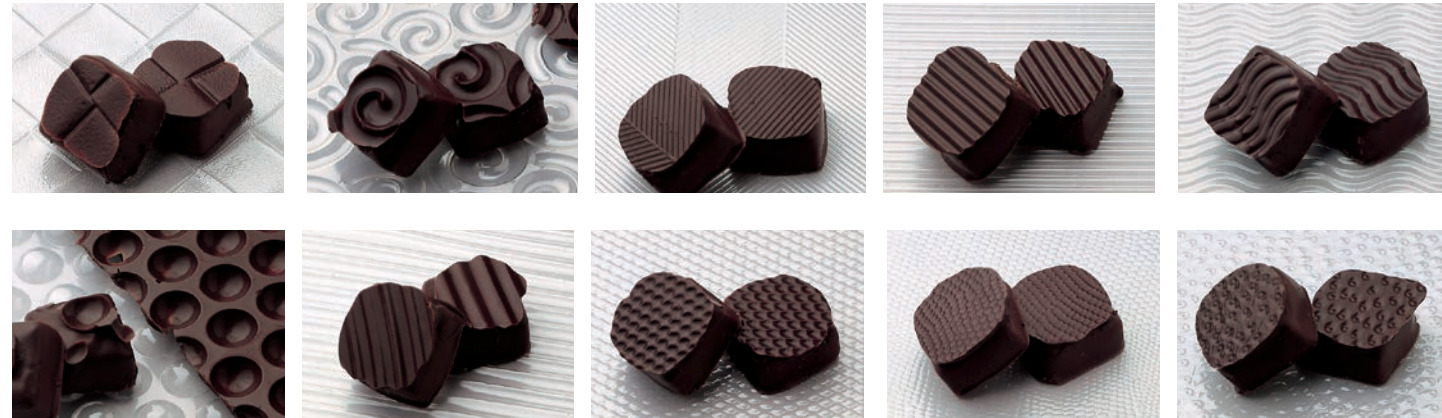

PACKAGING



Bordo satinato - Satin glim boxes

Alveoli trasparenti - Transparent cavities
31x26 h 10mm - pack 25 pcs

Misure Size mm	Alveoli Cavities	Codice Code
100x115 h23	6	MSC201
210x100 h23	12	MSC202



Scatole trasparenti - Transparent boxes

Alveoli trasparenti - transparent cavities
31x26 h 10mm - pack 25 pcs

Misure Size mm	Alveoli Cavities	Codice Code
160x40 h20	5	MSC001
110x100 h20	9	MSC002
220x65 h20	12	MSC003
160x150 h20	20	MSC004

Mart box

Mart Box: tagliato da te

Pratico sistema per realizzare il confezionamento perfetto per le tue creazioni, adattandolo ad ogni specifica esigenza. Mart Box è composto da una bobina in plastica trasparente lunga 15 mt che potrà facilmente essere tagliata nella misura desiderata e completata con coperchi double-face.

Mart Box: cut by you

A practical system to realize the perfect packaging for your creations and to adapt it in any specific requirement. Mart Box is composed of a 15 m long transparent plastic reel that can be easily cut up into desired lengths and completed with double-face covers.



Metti in mostra il lato che preferisci: abbinare al tuo Mart Box il seguente coperchio double-face.
Show the favourite side: match your Mart Box with the following double-face cover.



48x48mm 22BOX48
60x60mm 22BOX60
85x85mm 22BOX85

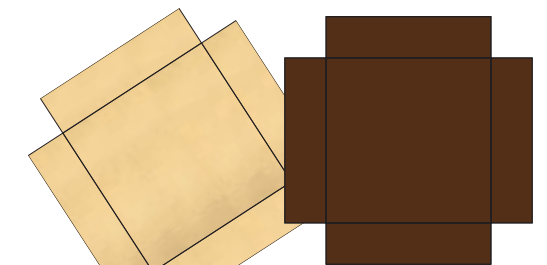

oro - marrone
gold side - brown side

Size mm	pcs	Code
48x48	100	22BOX48T4
60x60	100	22BOX60T4
85x85	100	22BOX85T4

Realizzato in materiale plastico termoresistente, con vasca e coperchio rimovibile in acciaio inox e sonda termica per la regolazione della temperatura del cioccolato. La scheda elettronica gestisce la resistenza interna e la rilevazione della temperatura del cioccolato tramite la sonda esterna per ottimizzare il raggiungimento del risultato richiesto e per consentire un più rapido e preciso scioglimento del cioccolato. Il pannello frontale fornisce suggerimenti per il temperaggio, regolabile manualmente o seguendo i 3 programmi differenti in base al tipo di cioccolato: bianco, al latte o fondente. Le indicazioni del display aiutano l'operatore a completare le fasi del temperaggio e del mantenimento del cioccolato.

DigitalMeltinChoc

MADE IN ITALY

Made of heat-resistant plastic material, with a stainless steel tank and removable lid and a thermal probe for the regulation of the chocolate temperature. The electronic card manages the internal resistance and the chocolate temperature detection through the external probe to optimize the achievement of the required result and to allow a faster and more precise melting of the chocolate.

The front panel provides suggestions for tempering, adjustable manually or by following the 3 different programs according to the type of chocolate: white, milk or dark chocolate. The display indications help the operator to complete the tempering and chocolate maintenance phases.

- **Temperatura costante ed omogenea**
Constant and homogenous temperature
- **Vasca estraibile in acciaio inox**
Removable stainless steel basin
- **Programmi selezionabili**
Preset programs
- **Rapido scioglimento**
Quick melting
- **Controllo digitale**
Digital control
- **Display grafico**
Graphic display
- **Sonda termica**
Thermal probe
- **Indicatori sonori**
Sound indicators



MCDA103
adatto per scioglitori
9L e 13,7L



KIT SUPPORTO STAMPO E PULISCI SPATOLA IN ACCIAIO INOX
STAINLESS STEEL MOULD SUPPORT AND SPATULA CLEANER



3,6 L

MCD101
24x40 h13,5cm
Vasca - Basin: 18x32,5 h10cm



6 L

MCD102
33x40 h13,5cm
Vasca - Basin: 26,5x32 h10cm



9 L

MCD103
39,5x45 h13,5cm
Vasca - Basin: 32x35,3 h10cm



13,7 L

MCD104
39,5x62 h13,5cm
Vasca - Basin: 32,5x53 h10cm

Su richiesta disponibili scioglitori con cablaggio
GB / USA / GIAPPONE / AUSTRALIA / CINA.

UK / US / JAPAN / AUSTRALIA / CHINA
wirings available upon request.

Meltingchoc

MADE IN ITALY

MELTINGCHOC ANALOGICI

I Meltingchoc sono degli strumenti indispensabili per la lavorazione del cioccolato. Precisione, design, semplicità e ingombro ridotto sono i principali vantaggi di questi dispositivi in grado di soddisfare anche i pasticceri più esigenti. Gli scioglitori a secco analogici sono dotati di una pratica **vasca in acciaio inox** removibile con scocca in plastica. Il termostato manuale permette di regolare e mantenere il cioccolato alla temperatura desiderata. Realizzati in materiale plastico termoresistente, gli scioglitori per cioccolato hanno capienze comprese tra 0,8 e 13 litri.

ANALOGUE MELTINGCHOC

The Meltingchoc are essential tools for chocolate processing. Precision, design, ease of use and compactness are the main advantages of these devices, designed to meet the requirements of even the most demanding pastry chef. These dry heat analogue melters are equipped with a practical and removable **stainless steel tank** with plastic chassis. The manual thermostat allows you to adjust and maintain the chocolate at the desired temperature.

Made with heat-resistant plastic, the chocolate melters can hold from 0,8 to 13 liters.



Scocca in resistente materiale plastico
Shell made of durable plastic material

Termostato a regolazione manuale
Manual regulation thermostat

MONO



1,5 L
MC105
24x26 h13,5cm
Vasca - Basin: 14x15,5 h10cm



3,6 L
MC101
24x40 h13,5cm
Vasca - Basin: 18x32,5 h10cm



6 L
MC102
33x40 h13,5cm
Vasca - Basin: 26,5x32 h10cm



9 L
MC103
39,5x45 h13,5cm
Vasca - Basin: 32x35,3 h10cm



13,7 L
MC104
39,5x62 h13,5cm
Vasca - Basin: 32,5x53 h10cm

MULTI



0,8x3 L
MC107
Misure - Size: 39,5x26,5 h13,5cm
Vasca - Basin: 8,3x15 h10cm
Mono Termostato - Mono-Thermostat



1,5x2 L
MC108
42x26 h13,5cm
Vasca - Basin: 14x15,5 h10cm
Multi Termostato - Multi-Thermostat



1,5x3 L
MC100
61x26 h13,5cm
Vasca - Basin: 14x15,5 h10cm
Multi Termostato - Multi-Thermostat



1,5x4 L
MC106
79x26 h13,5cm
Vasca - Basin: 14x15,5 h10cm
Multi Termostato - Multi-Thermostat

MiniMeltinchoc

MADE IN ITALY

Il **mini scioglitore a secco per cioccolato** è adatto sia in laboratorio per piccole produzioni di praline e soggetti, che in gelateria per la copertura di gelati e dessert su stecco. La capacità contenuta consente la lavorazione di piccole quantità senza sprechi e la **pratica vasca estraibile** garantisce una manutenzione facile e veloce. Il **design raffinato** e le **dimensioni ridotte** lo rendono perfetto per l'utilizzo anche direttamente sul bancone.

The **mini dry melter for chocolate** is suitable both in the laboratory for small productions of pralines and subjects, and in ice-cream shops for covering ice cream and desserts on a stick. The small capacity allows to process tiny chocolate quantities without any waste. The **practical removable tank** ensures an easy and fast maintenance. The **refined design** and **compact size** make it perfect to be used even directly on the counter.

Nero - Black
MC09N

Rosso - Red
MC09R

Grigio - Gray
MC09G

Lilla - Lilac
MC09L

Verde - Green
MC09V



Termostato a regolazione manuale
Manual regulation thermostat

Scocca in resistente materiale plastico
Shell made of durable plastic material

1,8 L

Misure - Size:
26x26 h16 cm



Vaschetta - Basin
MC000305

Vasca estraibile in alluminio anodizzato
Removable basin in anodized aluminum
Ø 18,5 h10,7 cm

DeepMeltinchoc

MADE IN ITALY

Scioglitore a secco pensato per le gelaterie: grazie alla sua forma e dimensione è ideale per coperture in cioccolato di gelati e semifreddi su stecco. Presentato con colorazione classica, che ricorda i toni del cioccolato, per adattarsi ad ogni tipologia di arredo e per essere utilizzato direttamente sul banco. Le caratteristiche tecniche dello scioglitore analogico, tra cui il termostato che consente di regolare la temperatura e la vasca estraibile in alluminio anodizzato per una più facile pulizia, fanno di DEEP-MELTINCHOC un articolo essenziale.

Dry melter designed for ice-cream shops: thanks to its shape and size it is ideal for chocolate coatings of ice-creams and semifreddos on sticks. Presented with classic colours, reminiscent of chocolate tones, to adapt to all types of furnishings and to be used directly on the counter.

The technical features of the analogue melter, including the thermostat that allows you to adjust the temperature and the removable tank in anodised aluminium for easier cleaning, make DEEP-MELTINCHOC an essential item.



1,7 L

Deep Meltinchoc
MC10
Ø 20,5 h21,2 cm



Vaschetta - Basin
MC001001

Vasca estraibile in alluminio anodizzato
Removable basin in anodized aluminum
Ø 14 h18 cm

Scocca, coperchio e fondo in resistente materiale plastico
Body, lid and bottom in durable plastic material

Chocobig

EVOLUTION

Versatile, di facile utilizzo e di sicuro effetto. Ideale per pasticcerie, gelateria, ristoranti, alberghi e servizi catering.

La fontana Martellato, realizzata in Italia, è completamente in acciaio inox, ha la vasca smontabile per rendere svuotamento e pulizia molto facili. La manopola consente di regolare la temperatura e lo spegnimento automatico ne evita il surriscaldamento. Per il funzionamento richiede circa 3,5 kg di cioccolato e può contenerne fino a 8 kg.

Versatile, easy to use and highly impactful. Ideal for pastry shops, ice cream parlours, restaurants, hotels and catering services.

The Martellato fountain, made in Italy, is completely in stainless steel and has a removable basin to make emptying and cleaning very easy. The control knob allows you to adjust the temperature and the automatic switch-off prevents overheating. It requires about 3.5 kg of chocolate to operate and can hold up to 8 kg.



- ✓ MADE IN ITALY
- ✓ FUNZIONAMENTO SILENZIOSO
SILENT OPERATION
- ✓ COCLEA IN ACCIAIO INOX
STAINLESS STEEL AUGER
- ✓ VASCA SMONTABILE
DISASSEMBLING BOWL

CHOCOBIGEV
Ø 380 h800 mm
Cap: ~ 3,5 lt
230V - 50 Hz
Amps 1.6A - 370W

ACCESSORI - ACCESSORIES

Copri fontana in plexiglass con comodi ripiani.
Plexiglass ring cover for chocolate fountain with useful displayers.

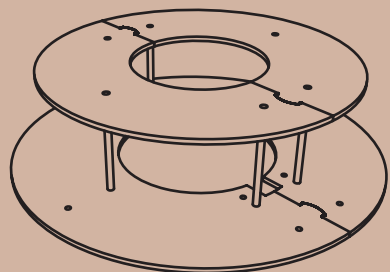

CHOCOBIGRING06
Satinato - Satin-finish
Ø 650 mm x h 170mm

Chocolate Fountain



Compatta e leggera, la più piccola delle nostre fontane è adatta a sciogliere e mantenere il cioccolato alla temperatura desiderata nelle occasioni più informali o con spazi contenuti.

Compact and light, the smallest of our fountains is suitable for melting and maintaining chocolate at the desired temperature on the most informal occasions or with limited space.

- ✓ FONTANA IN ACCIAIO INOX
STAINLESS STEEL FOUNTAIN
- ✓ COCLEA IN PLASTICA RESISTENTE
AUGER IN HEAT RESISTANT PLASTIC
- ✓ PIEDINI REGOLABILI
ADJUSTABLE FEET

Mantiene la cioccolata alla temperatura di 36/39°C.
It keeps the chocolate at a temperature of 36/39°C.

CHOCOFONT
Ø 210mm h390mm
Cap.: ~ 1 lt
220 - 240V - 50 Hz
Amps 0,77A - 170W

ACCESSORI - ACCESSORIES

Copri fontana in plexiglass con comodi ripiani.
Plexiglass ring cover for chocolate fountain with useful displayers.

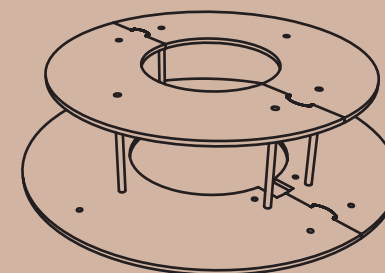

CHOCORING06
Satinato - Satin-finish
Ø 520mm x h 160mm

SEMIFREDDO & BAKING

TRAVEL CAKE
—○—
Geometric
by
FRANK HAASNOOT



Dalla collaborazione tra Martellato e **Frank Haasnoot** nascono **nuove forme** per interpretare l'iconico Travel cake. **Stampi in acciaio inox**, realizzati in Italia, con inserto tubolare facilmente estraibile dopo la cottura, per consentire la farcitura del dolce anche con ripieni non da forno.

Made in Italy.

New shapes come from the collaboration between Martellato and **Frank Haasnoot**, to interpret the iconic Travel cake. Made in Italy **stainless steel moulds** with an easily removable after baking tubular insert, to fill the cakes with non-baked fillings.

Made in Italy.

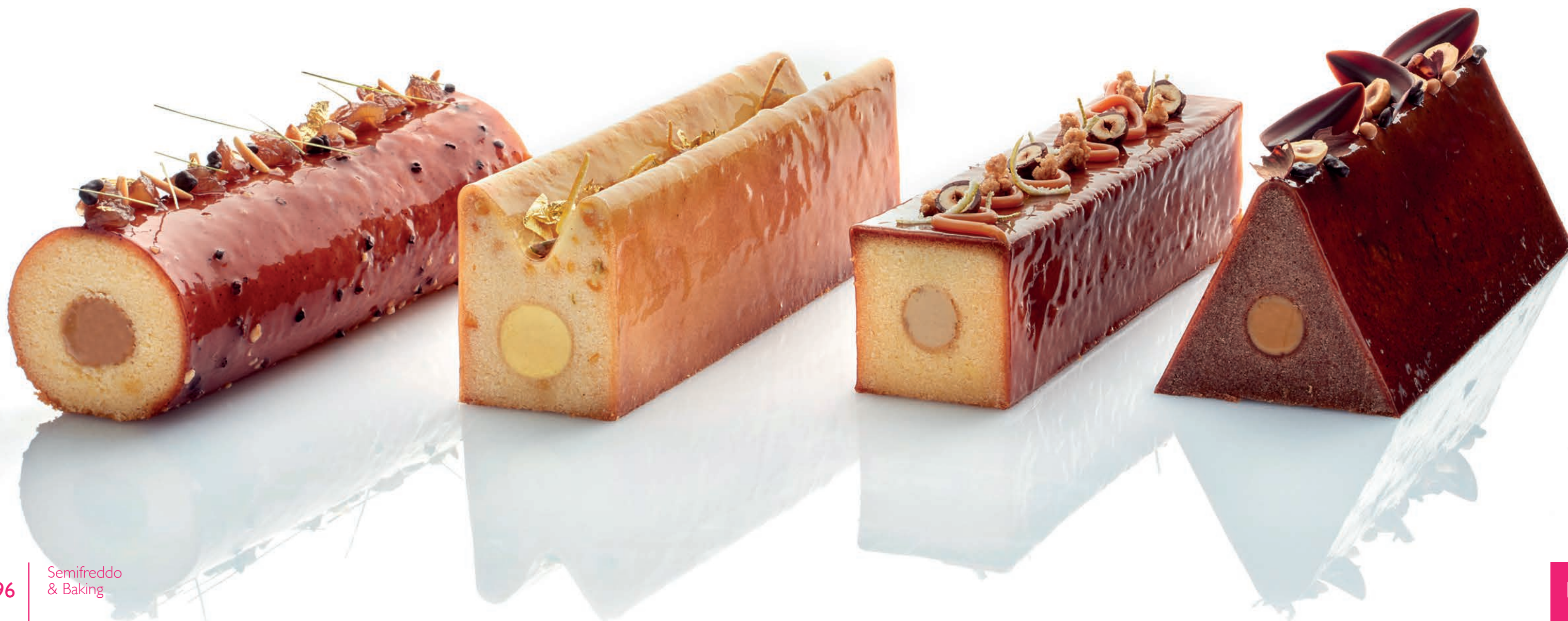

CARRÉ

30TC51F

Mould 82 x 290 h 64 mm
 Cake 60 x 250 h 60 mm
 Vol. ~ 900 ml
 Prod. su teglia/on tray 60x40: 8 pcs

30TC50F

Mould 103 x 190 h 70 mm
 Cake 80 x 150 h 69 mm
 Vol. ~ 850 ml
 Prod. su teglia/on tray 60x40: 10 pcs



ROUND

30TC54F

Mould Ø 82 x 290 mm
 Cake Ø 78 x 250 mm
 Vol. ~ 1050 ml
 Prod. su teglia/on tray 60x40: 8 pcs



TRIANGLE

30TC52F

Mould 88 x 290 x h 85 mm
 Cake 82 x 250 h 80 mm
 Vol. ~ 890 ml
 Prod. su teglia/on tray 60x40: 6 pcs



CUBÓ

30TC55

Mould 130 x 86 h 83 mm
 Cake 80 x 80 h 80 mm
 Vol. ~ 510 ml
 Prod. su teglia/on tray 60x40: 20 pcs



FANCY

30TC53F

Mould 83,5 x 290 h 86 mm
 Cake 60 x 250 h 80 mm
 Vol. ~ 960 ml
 Prod. su teglia/on tray 60x40: 8 pcs

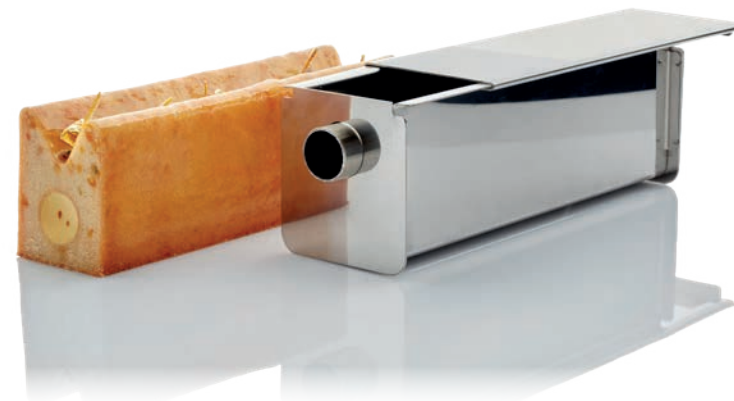

BLOCK & OVAL

30TC56

Mould 255 x 84 h 62 mm
 Cake 250 x 60 h 60 mm
 Block Vol. ~ 900 ml - Oval Vol. ~ 790 ml
 Prod. su teglia/on tray 60x40: 8 pcs



i MICRO BANDS FORATI

The perfect baking solution

Fasce in silicone microforato, che abbinare agli stampi in acciaio inox, garantiscono cottura omogenea e senza umidità, sfornatura facile senza rotture e una texture regolare ed elegante.

Micro-perforated silicone bands, which combined with the stainless steel moulds, guarantee even cooking without humidity, easy demoulding without breakings and a regular and elegant texture.



"I MicroforatiBands sono la soluzione ideale per la razionalizzazione della produzione, la riduzione degli sprechi e un risultato estetico ineguagliabile."

"The MicroforatiBands are the ideal solution for production optimization, waste reduction and unique aesthetics results"

Denis Dianin AMPI Pastry Chef



EFFICIENZA PRODUTTIVA

- **RAZIONALIZZAZIONE DELLA PRODUZIONE**
semplificando i passaggi e riducendo i tempi di circa il 30%
- **COTTURA OMOGENEA E SENZA IMPERFEZIONI**
in quanto permette la fuoriuscita dell'umidità
- **SFORMATURA VELOCE E SENZA ROTTURE**
favorendo la rimozione del prodotto sia a caldo che a freddo
- **RIDUZIONE DEGLI SPRECHI E DEI COSTI**
meno spreco di prodotto perché si avrà il 99 % di successo nella produzione



PRODUCTION OPTIMIZATION

- **PRODUCTION RATIONALIZATION**
by simplifying the steps and reducing times by around 30%
- **EVEN COOKING WITH ZERO IMPERFECTIONS**
because they allow moisture to escape
- **QUICK DEMOULDING WITHOUT BREAKINGS**
by allowing the unmoulding of both hot and cold products
- **WASTE AND COST REDUCTION**
less product waste because you will have a 99% success rate with your production





MODELLI MODELS

30BANDS01	500xh25 mm 10 pcs	for	Ø 14 - 16	h 2,5 cm	
30BANDS02	625xh25 mm 10 pcs	for	Ø 18 - 20	h 2,5 cm	
30BANDS03	750xh25 mm 10 pcs	for	Ø 22 - 24	h 2,5 cm	
30BANDS04	500xh35 mm 10 pcs	for	Ø 14 - 16	h 3,5 cm	
30BANDS05	625xh35 mm 10 pcs	for	Ø 18 - 20	h 3,5 cm	
30BANDS06	750xh35 mm 10 pcs	for	Ø 22 - 24	h 3,5 cm	
30BANDS07	260xh20 mm 20 pcs	for	Ø 8	h 2 cm	



+230°C
+446°F



RISULTATI PERFETTI

- ADATTABILITÀ A TUTTE LE FORME E A TUTTE LE RICETTE
- TEXTURE ELEGANTE ed esclusiva
- BORDI SOTTILI e DRITTI che non collassano perché sostenuti dalla fascia
- MINIMO SPAZIO DI STOCCAGGIO e FACILE GESTIONE lavaggio ed asciugatura rapidi

PERFECT RESULTS

- ADAPTABILITY TO ALL SHAPES AND RECIPES
- ELEGANT AND EXCLUSIVE texture
- THIN AND STRAIGHT EDGES that don't collapse because supported by the band
- MINIMUM STORAGE AREA AND EASY MANAGEMENT quick washing and drying



PRODOTTI CORRELATI RELATED PRODUCTS

Fasce inox
Stainless steel bands



1H2X8	Ø8 h2 cm
1H25X14	Ø14 h2,5 cm
1H25X16	Ø16 h2,5 cm
1H25X18	Ø18 h2,5 cm
1H25X20	Ø20 h2,5 cm
1H25X22	Ø22 h2,5 cm
1H25X24	Ø24 h2,5 cm
1H35X14	Ø14 h3,5 cm
1H35X16	Ø16 h3,5 cm
1H35X18	Ø18 h3,5 cm
1H35X20	Ø20 h3,5 cm
1H35X22	Ø22 h3,5 cm
1H35X24	Ø24 h3,5 cm



5H25X14	14X14 h2,5 cm
5H25X16	16X16 h2,5 cm
5H25X18	18X18 h2,5 cm
5H35X14	14X14 h3,5 cm
5H35X16	16X16 h3,5 cm
5H35X18	18X18 h3,5 cm

Tappeto in silicone microforato
Micro-perforated silicone mat

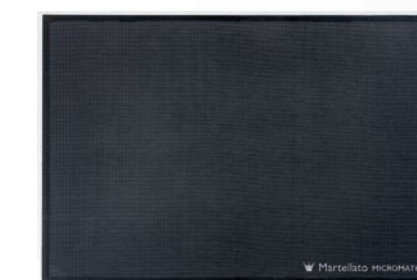

+230°C
+446°F

MICROMAT60	38,5 x 58,5 cm
MICROMAT30	38,5 x 28,5 cm

Dime - Template

Dime in plastica trasparente per il taglio in strisce regolari di pastafrolla, cioccolato e biscuit.
Transparent plastic grids for cutting regular strips of pastry, chocolate and biscuit.

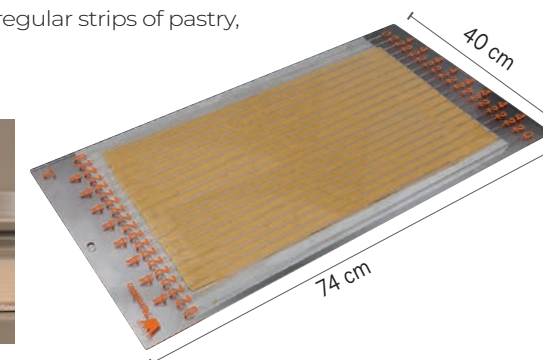

50GD0022	prod. 15 str.	60 x h2,2 cm
50GD0027	prod. 12 str.	60 x h2,7 cm
50GD0037	prod. 9 str.	60 x h3,7 cm

i MICRO FORATI

stampi silicone
silicone moulds

30x40

1 box: 2 stampi/moulds

Una linea di prodotti per cotture in forno, realizzati in silicone e fibra di vetro, pensati per facilitare il lavoro in laboratorio.

Le caratteristiche che li contraddistinguono, come l'alta qualità dei materiali e la texture microforata, consentono la diffusione uniforme del calore e l'uscita dell'umidità, riducendo i tempi di cottura e garantendo un risultato perfetto.

Tante forme ideali per le diverse preparazioni sia dolci che salate, come tartellette classiche e moderne, brioche e muffin.

Le creazioni risulteranno perfettamente croccanti e dalla forma impeccabile, senza bolle o cedimenti.

Sono ideali anche per i lievitati, pasta frolla e brisée. I tappeti sono antiaderenti e possono essere usati da entrambi i lati, per preparare tartellette vuote o già farcite.

A line of products for oven baking, made of silicone and fibreglass, designed to simplify work in the laboratory.

The characteristics that distinguish them, such as the high quality of the materials and the micro-perforated texture, allow the uniform diffusion of heat and the exit of humidity, reducing cooking times and guaranteeing a perfect result.

The many different shapes are ideal for various preparations, both sweet and savoury, such as classic and modern tartlets, brioche and muffins.

The creations will be perfectly crunchy and impeccably shaped, without bubbles or sagging.

They are also ideal for leavened products, shortcrust pastry and brisée.

The mats are non-stick and can be used on both sides to prepare empty or already filled tartlets.

1 confezione = 2 stampi 30x40 per teglie 60x40

1 pack = 2 moulds 30x40 for 60x40 trays

PLUS

Scopri i valori aggiunti che rivoluzionano la cottura in forno. Discover the added values that revolutionise oven cooking.

RESISTENTI

Il silicone arricchito con fibra di vetro garantisce alta qualità e maggiore durata degli stampi.

Resiste a temperature fino a:
+230°C +450°F

RESISTANT

The silicone enriched with glass fibre guarantees high quality and longer life of the moulds.

Resistant up to:
+ 230 ° C + 450 ° F

PRATICI

Le sformature sono più facili grazie all'antiaderenza del materiale

PRACTICAL

Demoulding is easier thanks to the material non-stick qualities

FUNZIONALI

La microforatura assicura una cottura veloce e uniforme, priva dell'umidità in eccesso

FUNCTIONAL

Microperforation ensures even and quick cooking with no humidity excess

VERSATILI

Possono essere usati da entrambi i lati per risultati creativi

VERSATILE

Can be used on both sides for creative results

MULTIUSO

Consentono di realizzare qualsiasi tipo di ricetta, dolce o salata

MULTI-USE

Allow making any type of sweet or savoury recipe

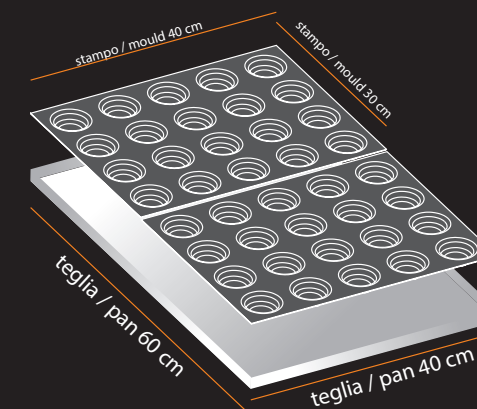

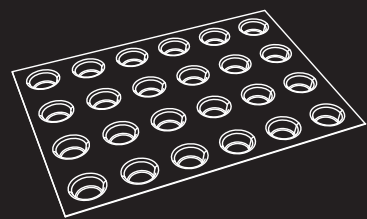

h16
Ø40mm
30MICRO01
Prod: 24+24 pcs

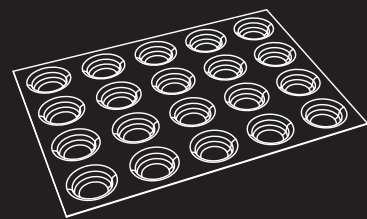

h16
Ø50mm
30MICRO02
Prod: 20+20 pcs

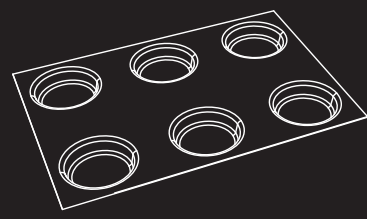

h20
Ø85mm
30MICRO04
Prod: 6+6 pcs

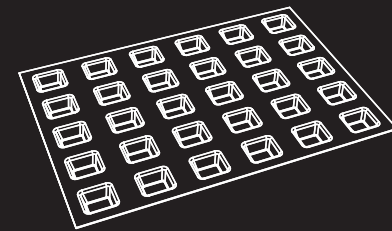

h16
35x35mm
30MICRO06
Prod: 30+30 pcs

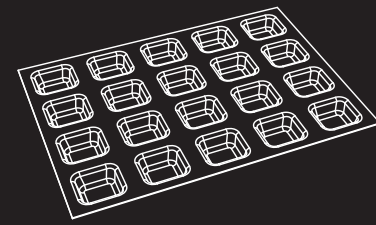

h20
50x50mm
30MICRO07
Prod: 20+20 pcs

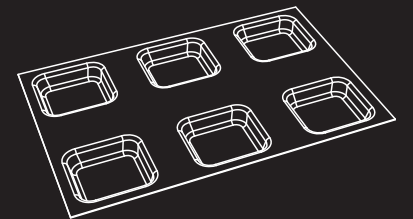

h20
85x85mm
30MICRO08
Prod: 6+6 pcs

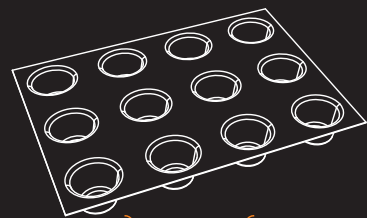

h40mm
Ø60mm
30MICRO03
Prod: 12+12 pcs

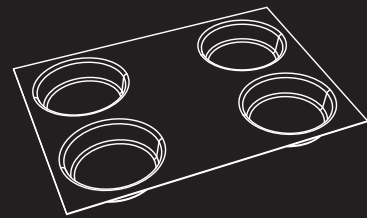

h30mm
Ø120mm
30MICRO05
Prod: 4+4 pcs

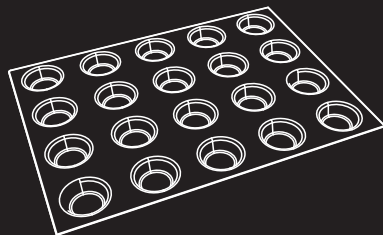

h22
Ø48mm
30MICRO10
Prod: 20+20 pcs

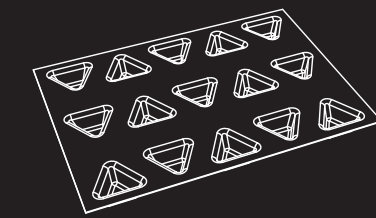

h25mm
60mm
30MICRO09
Prod: 15+15 pcs

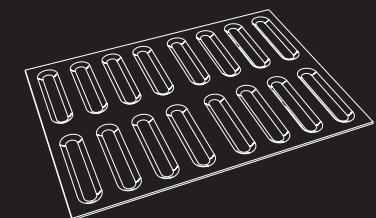

h6mm
120mm
30MICRO11
Prod: 16+16 pcs
120x25 - h6mm





IL FUTURO È IN UN GESTO

Una nuova generazione di stampi Made in Italy che stanno cambiando il modo di lavorare in laboratorio.
Pratici, economici e veloci, gli stampi monouso per torte e individual cake consentono di velocizzare la produzione di semifreddi, risparmiando tempo, riducendo i costi, eliminando l'uso di detersivi e il consumo di acqua dovuto ai lavaggi.

THE FUTURE IS IN ONE MOVE

A new generation of Made in Italy moulds that are changing the way professionals work in the laboratory.
Practical, economical and fast, disposable moulds for cakes and individual cakes allow you to speed up production of semifreddo, saving time, reducing costs and eliminating the use of detergents and water consumption due to washing.

100% 
RECYCLABLE





PERCHÉ SCEGLIERE ONE STRIP?

Con One Strip avrai:

- **30%** dei TEMPI di produzione
- **15%** del COSTO dei materiali
- **20%** della MANODOPERA
- **25%** dei CONSUMI

WHY CHOOSE ONE STRIP?

One Strip saves:

- **30%** of production TIMES
- **15%** of the COSTS of materials
- **20%** of LABOUR
- **25%** of CONSUMPTION

CAKE MOULD

ONE14H35

Ø 140 x h 35 mm
Pack 140 pcs

ONE14H40

Ø 140 x h 40 mm
Pack 140 pcs

ONE16

Ø 160 x h 40 mm
Pack 100 pcs

ONE18

Ø 180 x h 40 mm
Pack 100 pcs

ONE20

Ø 200 x h 40 mm
Pack 100 pcs

ONE22

Ø 220 x h 40 mm
Pack 100 pcs



INDIVIDUAL

ONE06

Ø 63 x h 40 mm
Prod. 6 pcs/bar
Pack 72 bars
Prod. for 60x40 tray
6x9=54 pcs





Una linea di stampi in silicone alimentare di alta qualità e design per esaltare l'estetica ed il gusto delle vostre produzioni. Forme moderne ed essenziali, facili da sfornare, che assicurano sempre ottimi risultati. Adatti per preparazioni sia dolci che salate, gli stampi made in Italy Martellato mantengono inalterate nel tempo le loro caratteristiche.

High quality and top design food grade silicone moulds to enhance the aesthetics and taste of your products. Modern and essential shapes, easy to unmould, that always ensure excellent results. Suitable for both sweet and savoury preparations, Martellato's made in Italy moulds maintain their characteristics and quality unchanged over time.

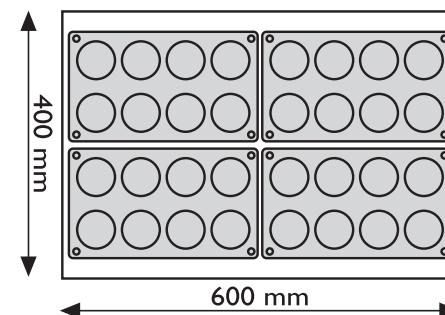

Stampi in silicone con scatola
Silicone moulds with box
Stampo/mould: 297 x 176 mm

Una teglia 60x40 può contenere
4 stampi 297 x 176 mm.
A 60x40 tray can contain
4 moulds 297 x 176 mm.

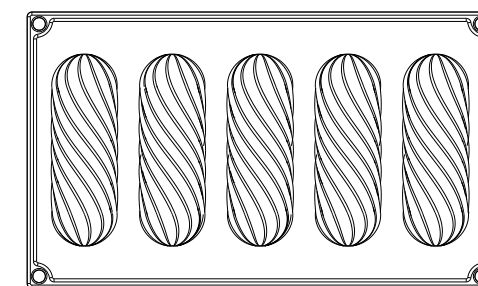

TWIST ECLAIR

30SIL505

Single portion: 120 x 40 h 33 mm
Vol. ~ 110 ml - Prod. 5 pcs

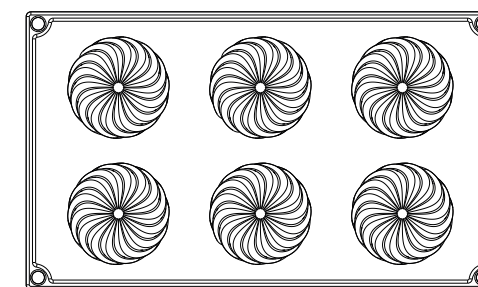

TWIST

30SIL506

Single portion: Ø 62 h 55 mm
Vol. ~ 110 ml - Prod. 6 pcs



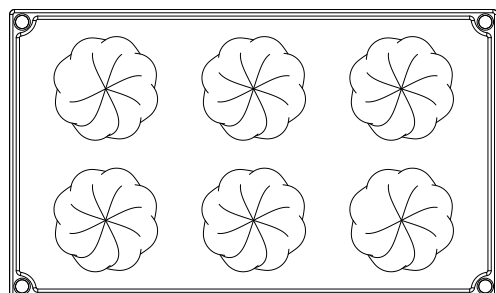

HARMONY

30SIL508

Single portion: 63 x 63 h 53 mm
Vol. ~ 110 ml - Prod. 6 pcs

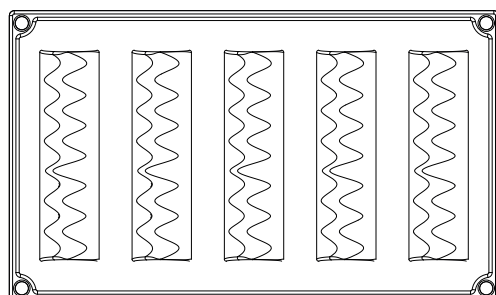

RITMO

30SIL509

Single portion: 128 x 36 h 32,5 mm
Vol. ~ 108 ml - Prod. 5 pcs



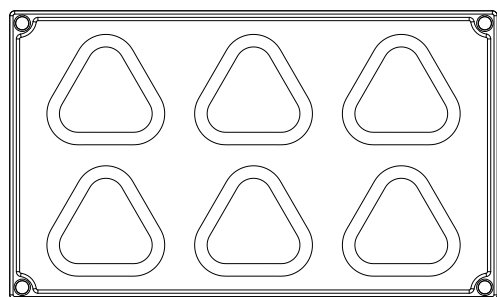

TRIANGLE

30SIL507

Single portion: 71,5 x 67 h 35,5 mm
Vol. ~ 104 ml - Prod. 6 pcs

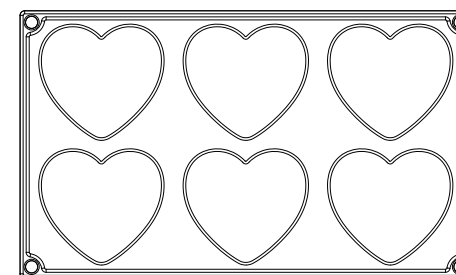
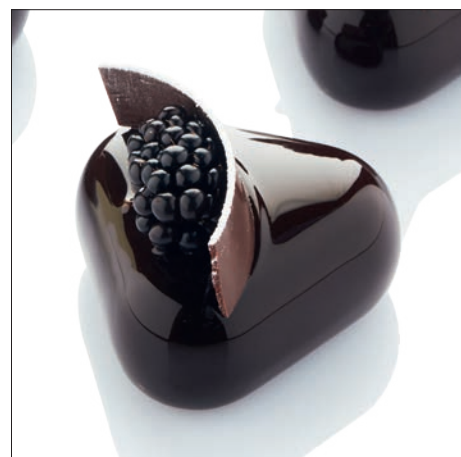

LOVE

30SIL502

Single portion: 74,5 x 68 h 30 mm
Vol. ~ 89 ml - Prod. 6 pcs

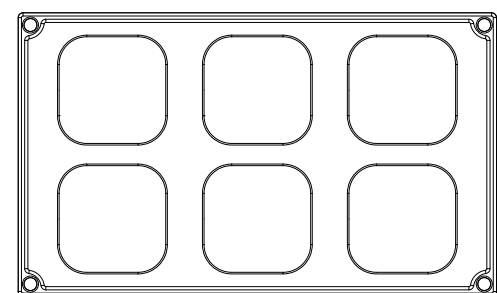
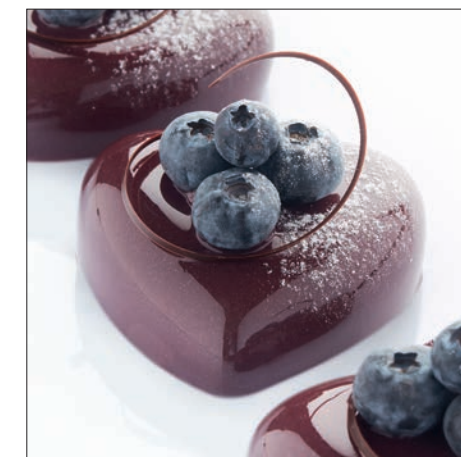

BOX

30SIL501

Single portion: 64 x 64 h 34 mm
Vol. ~ 115 ml - Prod. 6 pcs

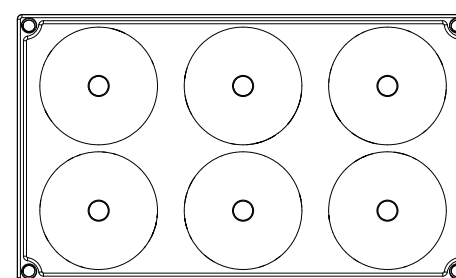

DONUTS

30SIL503

Single portion: Ø 75 h 25 mm
Vol. ~ 89 ml - Prod. 6 pcs

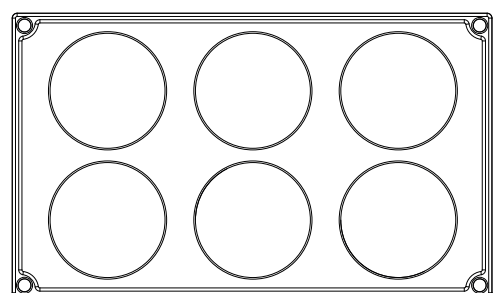

CIRCLE

30SIL500

Single portion: Ø 69 h 35 mm
Vol. ~ 110 ml - Prod. 6 pcs

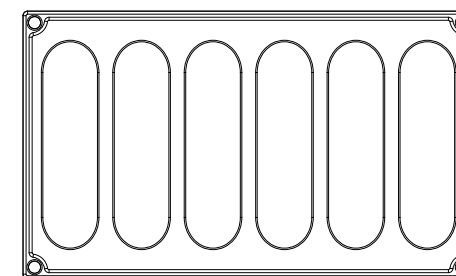

ECLAIR

30SIL504

Single portion: 130 x 30 h 28 mm
Vol. ~ 84 ml - Prod. 6 pcs



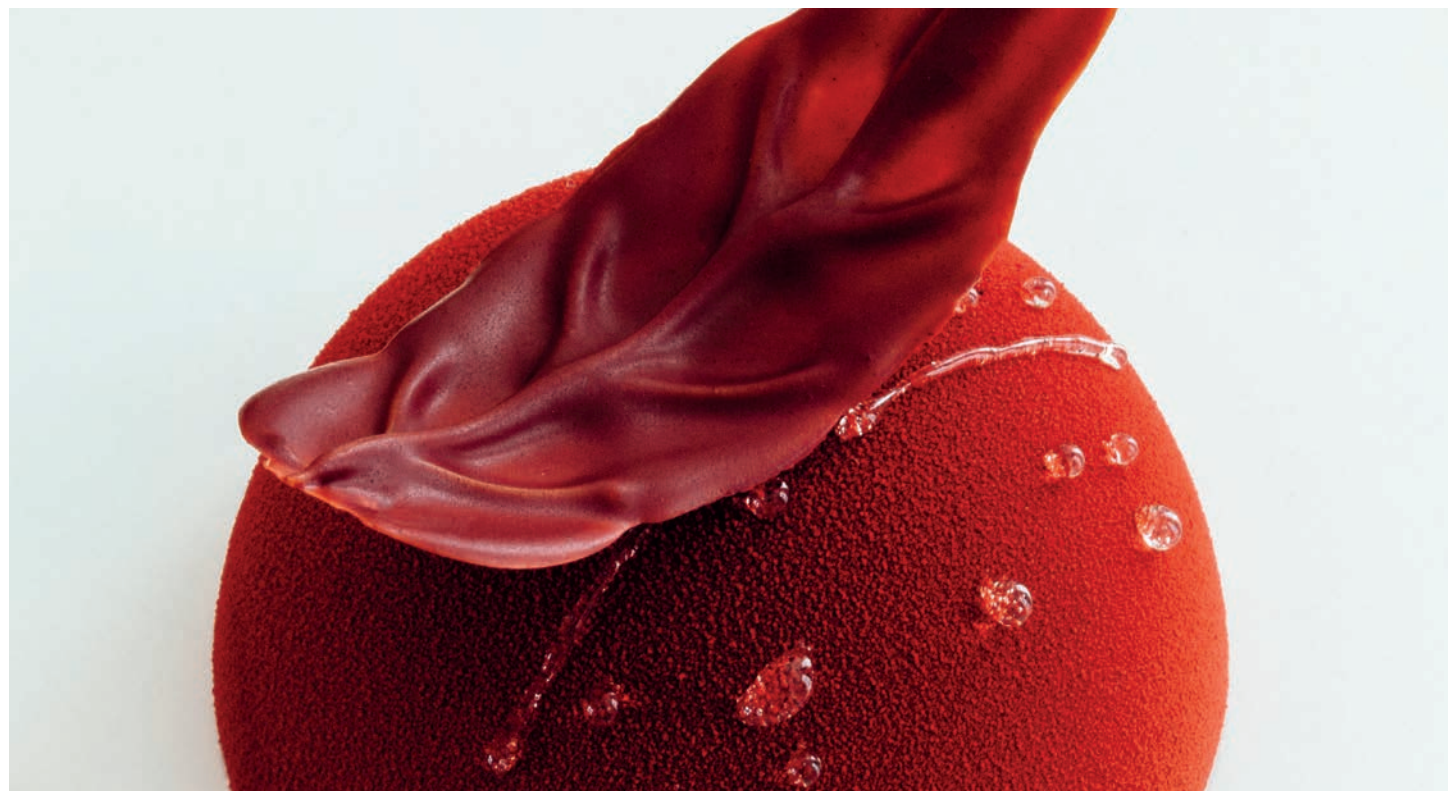

HALF-SPHERES



30SF001

Ø 80 h 40 mm
Prod. 5 pcs



30SF002

Ø 70 h 35 mm
Prod. 6 pcs



30SF003

Ø 60 h 30 mm
Prod. 6 pcs



30SF004

Ø 50 h 25 mm
Prod. 8 pcs



30SF005

Ø 40 h 20 mm
Prod. 15 pcs



30SF006

Ø 30 h 15 mm
Prod. 24 pcs



30SF500

Ø 45 h 22,5 mm
Prod. 15 pcs



30SF501

Ø 35 h 17,5 mm
Prod. 18 pcs



30SF502

Ø 25 h 12,5 mm
Prod. 28 pcs

OTHERS SHAPES



30SF032

68x45 h 17 mm
Prod. 9 pcs



30SF031

44x34 h 10 mm
Prod. 15 pcs



30SF180

Ø27 h11 mm
Prod. 40 pcs



30SF037

Ø38 h 26 mm
Prod. 15 pcs



30SF044

Ø50 h 14 mm
Prod. 15 pcs



30SF045

Ø60 h 17 mm
Prod. 8 pcs



30SF046

Ø70 h 17 mm
Prod. 6 pcs



30SF047

Ø80 h 18 mm
Prod. 6 pcs



30SF042

Ø100 h 20 mm
Prod. 3 pcs



30SF102

Ø68 h 38 mm
Prod. 6 pcs

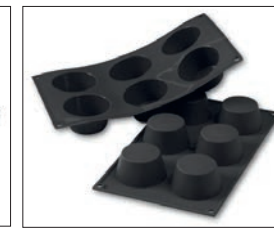

30SF023

Ø 69 h 35 mm
Prod. 6 pcs



30SF052

Ø75 h 60 mm
Prod. 6 pcs



30SF024

Ø 81 h 32 mm
Prod. 5 pcs



30SF022

Ø 51 h 28 mm
Prod. 11 pcs





30SF007

71x71 h 40 mm
Prod. 6 pcs

30SF008

36x36 h 22 mm
Prod. 15 pcs

30SF009

Ø 34 h 16 mm
Prod. 24 pcs

30SF013

Ø 45 h 10 mm
Prod. 15 pcs

30SF014

Ø 50 h 15 mm
Prod. 15 pcs



30SF058

Ø70 h 36 mm
Prod. 6 pcs

30SF059

Ø45 h 45 mm
Prod. 18 pcs

30SF060

50x25 h 20 mm
Prod. 20 pcs

30SF061

Ø75 h 40 mm
Prod. 2x3 pcs

30SF103

127,5x47 h 17 mm
Prod. 6 pcs

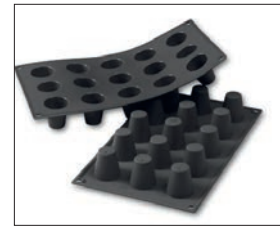

30SF015

Ø 60 h 17 mm
Prod. 8 pcs

30SF016

Ø 70 h 20 mm
Prod. 6 pcs

30SF017

55x33 h 20 mm
Prod. 16 pcs

30SF057

Ø55 h 36 mm
Prod. 8 pcs

30SF019

Ø 35 h 38 mm
Prod. 15 pcs

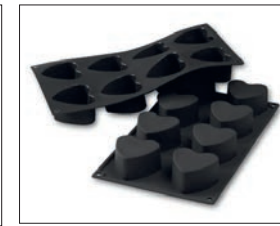
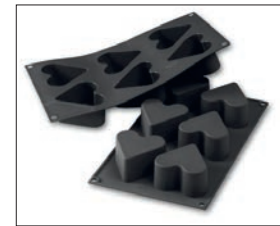

30SF036

Ø65 h 60 mm
Prod. 6 pcs

30SF040

Ø60 h 35 mm
Prod. 8 pcs

30SF054

95x45 h 12 mm
Prod. 7 pcs

30SF114

95x35 h 25 mm
Prod. 7 pcs

30SF161

125x28 h 5mm
Prod. 4 pcs



30SF020

Ø 45 h 48 mm
Prod. 11 pcs

30SF021

Ø 55 h 60 mm
Prod. 8 pcs

30SF022

Ø 51 h 28 mm
Prod. 11 pcs

30SF023

Ø 69 h 35 mm
Prod. 6 pcs

30SF024

Ø 81 h 32 mm
Prod. 5 pcs



30SF048

Ø35 h 23 mm
Prod. 18 pcs

30SF049

Ø68 h 45 mm
Prod. 6 pcs



30SF030

Ø35 h 5 mm
Prod. 24 pcs

30SF027

Ø40 h 20 mm
Prod. 15 pcs

30SF028

Ø60 h 35 mm
Prod. 8 pcs

30SF029

Ø60 h 12 mm
Prod. 8 pcs

30SF155

130x81 h 17mm
Prod. 4 pcs



30SF050

Ø55 h 50 mm
Prod. 8 pcs

30SF051

Ø57 h 57 mm
Prod. 8 pcs



30SF056

Ø70 h 28 mm
Prod. 6 pcs

30SF033

Ø35 h 35 mm
Prod. 18 pcs

30SF034

Ø76 h 37 mm
Prod. 6 pcs

30SF035

Ø79 h 30 mm
Prod. 6 pcs

30SF168

69x69 h 60mm
Prod. 6 pcs



30SF025

49x26 h 11 mm
Prod. 20 pcs

30SF026

79x29 h 30 mm
Prod. 12 pcs





MUFFIN

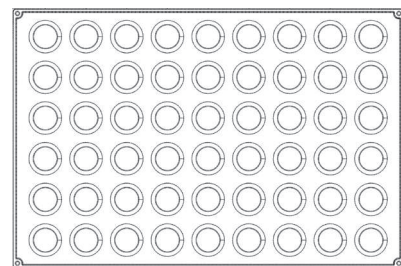
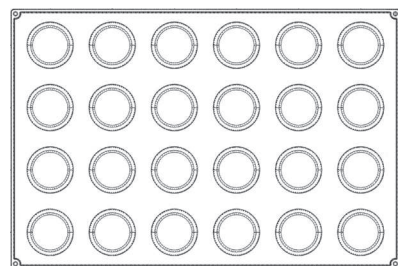

30SIL07N

Ø69 h 39 mm - Vol. ~ 120 ml
Prod. 24 pcs

30SIL06N

Ø50 h 28 mm - Vol. ~ 40 ml
Prod. 54 pcs

HALF-SPHERE

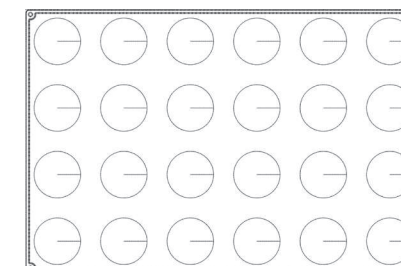
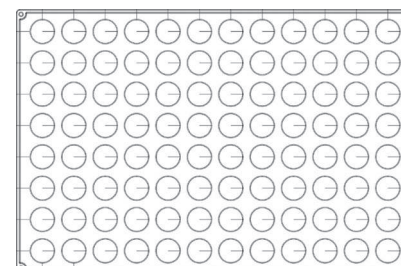

30SIL05N

Single portion: Ø 35 h 17,5 mm
Vol. ~ 10 ml - Prod. 96 pcs

30SIL04N

Single portion: Ø 70 h 35 mm
Vol. ~ 90 ml - Prod. 24 pcs

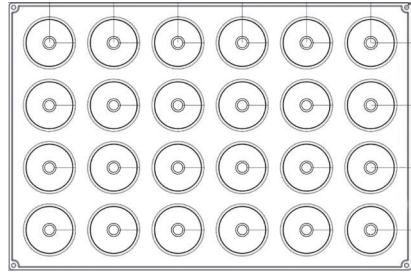

DONUTS

30SILO1N

Single portion: Ø 75 h 25 mm
Vol. ~ 89 ml - Prod. 24 pcs

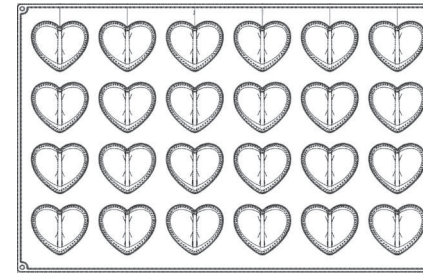

LOVE

30SILO3N

Single portion: 74,5 x 68 h 30 mm
Vol. ~ 89 ml - Prod. 24 pcs

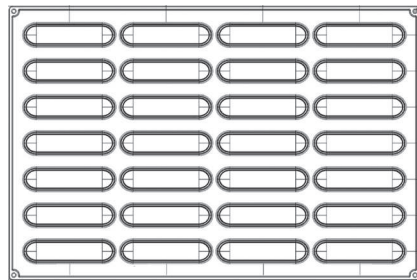

ECLAIR

30SILO2N

Single portion: 130 x 30 h 28 mm
Vol. ~ 84 ml - Prod. 28 pcs

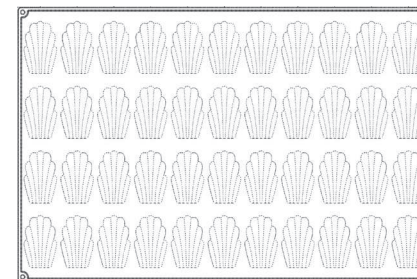

MADELINE

30SILO8N

Single portion: 74 x 45 h 18 mm
Vol. ~ 35 ml - Prod. 44 pcs



Baking Pan

Silicone Moulds

Stampi in silicone alimentare antiaderente e sono adatti all'uso in abbattitore e in forno.

Moulds made of non-stick food grade silicone suitable for use in blast chillers and ovens.



+230° / -60°C
+446° / -76°F



CUORE - HEART
SFT 210/Y
220x218 h 40 mm



MARGUERITE
SFT 220/Y
Ø220 h 45 mm



CIAMBELLA - SAVARIN
SFT 224/Y
Ø240 h 60 mm



GUGELHOPF
SFT 250/Y
Ø220 h 110 mm



ROSA - ROSE
SFT 251/Y
Ø220 h 100 mm



RECTANGULAR
SFT 300/Y
280x220 h 40 mm

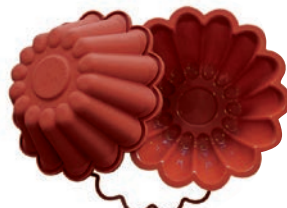

BRIOCHE
SFT 522/Y
Ø220 h 80 mm

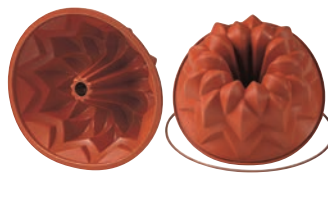

STAR BUNDT
SFT 600/Y
Ø240 h 100 mm



PLUM CAKE
SFT 326/Y
240x105 h 65 mm

SFT 330/Y
260x100 h 70 mm
con anello/with ring



CROSTATA - FLAN PAN
SFT 424/Y
Ø240 h 30 mm

SFT 426/Y
Ø260 h 30 mm

SFT 428/Y
Ø280 h 30 mm



TONDO - ROUND
SFT 118/Y
Ø180 h 40 mm

SFT 120/Y
Ø200 h 40 mm

SFT 122/Y
Ø220 h 42 mm

SFT 124/Y
Ø240 h 42 mm

SFT 128/Y
Ø280 h 47 mm

SFT 126/Y
Ø260 h 45 mm



Stampi per gelatine, in puro silicone alimentare, per la realizzazione di gelatine alla frutta, fondenti, ecc. Cornice in plastica. Stampo: 180x335 mm.

Jelly moulds, in pure food-grade silicone, for making fruit jellies, fondants, etc. Plastic frame. Mould: 180x335 mm



FETTA ARANCIA
ORANGE SLICE
SG 01
Size:45x18 h 15 mm
24 fig.



CUORE
HEART
SG 03
Size:34x30 h 18 mm
24 fig.



ANANAS
PINEAPPLE
SG 07
Size:33x23 h 18 mm
24 fig.



FRAGOLA
STRAWBERRY
SG 08
Size:36x30 h 20 mm
24 fig.



PESCA
PEACH
SG 09
Size:35x25 h 20 mm
24 fig.



MORA
BERRY
SG 06
Size:Ø30 h 24 mm
24 fig.



SEMISFERE
HALFSPHERE
SG 04
Size:Ø27 h 13,5 mm
24 fig.



PERA
PEAR
SG 02
Size:40x26 h 15 mm
24 fig.



BON BON
PASTILLE
SG 05
Size:Ø30 h 11 mm
24 fig.

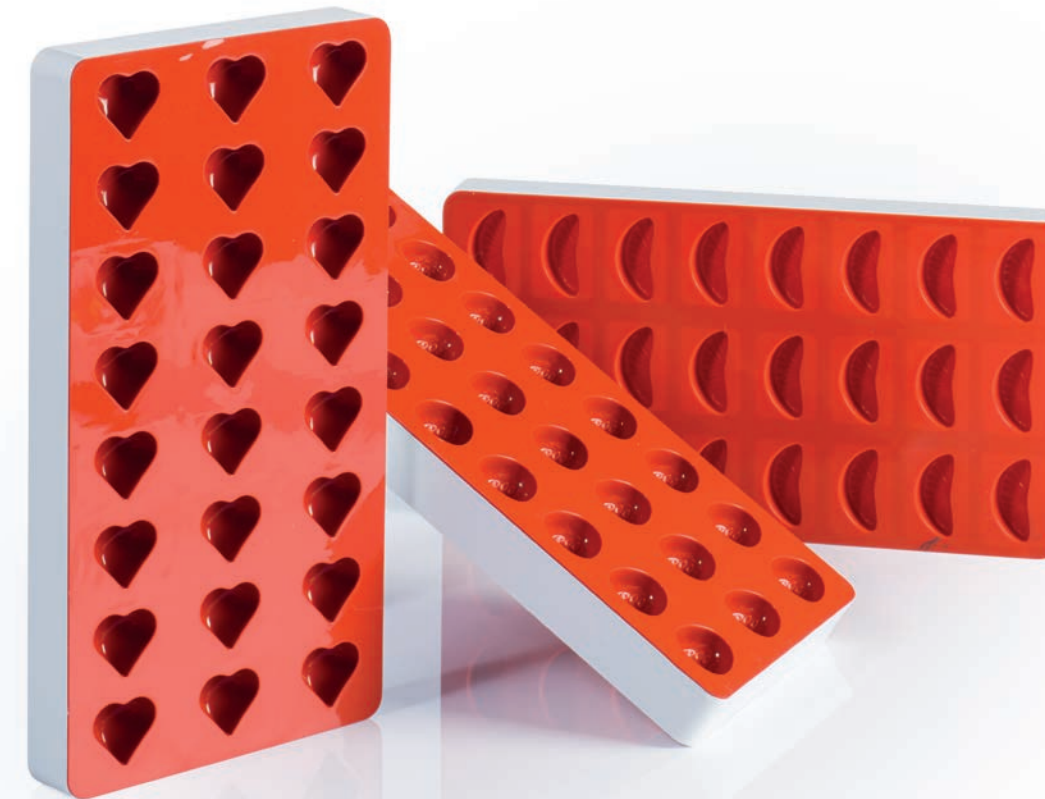

Eclair MANIA



TAPPETI SILICONE SILICONE MATS

Eclair 25x125mm
30TE6001R
58,5x38,6 cm - 36 pcs

30TE3001R
29,8x39,8 cm - 18 pcs

Mini Eclair 18x60mm
30TE6002R
58,5x38,6 cm - 70 pcs

30TE3002R
29,8x39,8 cm - 35 pcs



Macaron MANIA



TAPPETI SILICONE SILICONE MATS

Macaron Ø40mm
30TM6001R
58,5x38,6 cm
70 gusci/shells

Macaron Ø40mm
30TM3001R
30x40cm
34 gusci/shells



STAMPI PER DECORAZIONI DI CIOCCOLATO MOULDS FOR CHOCOLATE DECORATIONS

Eclair 25x125mm
20EC01
Kit 6 stamper / moulds
prod 36 pcs

Mini Eclair 18x60mm
20EC02
Kit 6 stamper / moulds
prod 72 pcs



TAGLIAPASTA PER DECORAZIONI PASTRY CUTTER FOR DECORATIONS

Eclair 25x125mm
31CUT01

Mini Eclair 18x60mm
31CUT02

DIME / TEMPLATE

Il prodotto va posizionato su foglio di carta da forno, la cui trasparenza permette di vedere dove posizionare l'impasto di Eclair / Macaron, e sfilato prima della cottura.

Non adatto alla cottura

The product must be placed on a sheet of baking paper, whose transparency allows to see where to place the mixture of Eclair / Macaron, and removed before baking.

Not suitable for cooking

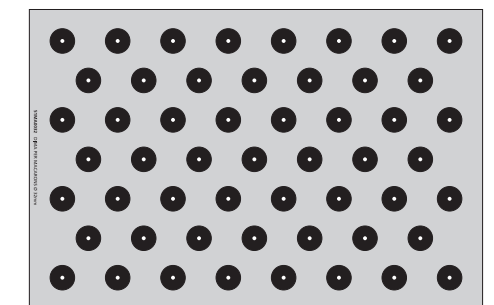

Macaron Ø32mm
51MA0032
Dima in plastica - Plastic template 59x39 cm
Prod. 53 gusci/shells



pastry RING

Fasce in acciaio inox di alta qualità con **bordi perfettamente dritti**, spessi per maggiore indeformabilità e **superficie liscia** per facilità di sformatura e dessert impeccabili. Adatti all'utilizzo sia in forno, dove assicurano cottura uniforme che in congelatore ed in abbattitore, per un completo e veloce raffreddamento., La varietà di forme e dimensioni, unita alle ampie possibilità di personalizzazione del soggetto su richiesta, rendono le fasce Martellato delle **soluzioni versatili** in grado di soddisfare anche i pasticceri più esigenti.

High quality stainless steel cake band with **perfectly straight edges**, more thickness for greater non-deformability and **smooth surface** for ease demoulding and flawless desserts. Suitable for use in freezer and blast chiller for a complete and fast cooling and ensure even cooking. The variety of shapes and sizes, combined with the wide customization opportunities upon request, make Martellato rings **very versatile products** able to satisfy even the most demanding pastry chefs.

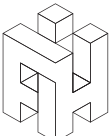

Created by  **FRANK
HAASNOOT**



STRIPE

H. 40 mm

49H4X25	62 x 252	600	ml
49H4X27	81 x 272	850	ml
49H4X29	92 x 292	1000	ml



PILLOW

H. 40 mm

46H4X18	67 x 182	360	ml
46H4X21	94 x 209	600	ml
46H4X27	121 x 270	1000	ml



QUENELLE

H. 40 mm

48H4X18	92 x 182	440	ml
48H4X23	124 x 227	750	ml
48H4X25	142 x 249	1000	ml



TRIS

H. 40 mm

47H4X15	146 x 134	510	ml
47H4X17	170 x 159	750	ml
47H4X20	197 x 184	1000	ml



DONUT

H. 40 mm

43H4X18 Ø 180 - foro/hole Ø 100 713 ml

43H4X20 Ø 200 - foro/hole Ø 120 813 ml



CALISSON

H. 40 mm

41H4X9 90 x 50 127 ml

41H4X15 150 x 83 353 ml

41H4X22 220 x 122 759 ml



DIAMOND CIRCLE

H. 40 mm

44H4X14 Ø 144 604 ml

44H4X17 Ø 171 850 ml

44H4X14 Ø 202 1200 ml



DIAMOND HEART

H. 40 mm

45H4X15	150 x 138	550	ml
45H4X19	186 x 171	850	ml
45H4X20	202 x 184	1000	ml



HEART

H. 50 mm

42H5X10	100 x 94	324	ml
42H5X12	120 x 113	466	ml
42H5X14	140 x 131	634	ml
42H5X16	160 x 150	828	ml
42H5X18	180 x 169	1048	ml
42H5X20	200 x 187	1294	ml
42H5X22	220 x 207	1550	ml
42H5X24	240 x 225	1845	ml
42H5X26	260 x 244	2170	ml
42H5X28	280 x 263	2540	ml

H. 40 mm

42H4X10	100 x 94	259	ml
42H4X12	120 x 113	373	ml
42H4X14	140 x 131	507	ml
42H4X16	160 x 150	663	ml
42H4X18	180 x 169	839	ml
42H4X20	200 x 187	1035	ml
42H4X22	220 x 207	1240	ml
42H4X24	240 x 225	1480	ml
42H4X26	260 x 244	1730	ml
42H4X28	280 x 263	2030	ml



INCLINED HEART

H. 40 mm

18H4X17	175 x 180	1490	ml
18H4X20	200 x 206	1010	ml
18H4X26	260 x 267	1704	ml

H. 50 mm

18H5X17	175 x 180	1863	ml
18H5X20	200 x 206	1262	ml
18H5X26	260 x 267	2130	ml

pastry
RING

ROUND



H. 60 mm

1H6X6	Ø 60	565	ml
1H6X8	Ø 80	754	ml
1H6X10	Ø 100	942	ml
1H6X12	Ø 120	1130	ml
1H6X14	Ø 140	1319	ml
1H6X16	Ø 160	1507	ml
1H6X18	Ø 180	1696	ml
1H6X20	Ø 200	1884	ml
1H6X22	Ø 220	2072	ml
1H6X24	Ø 240	2261	ml
1H6X26	Ø 260	3184	ml
1H6X28	Ø 280	3693	ml

H. 50 mm

1H5X10	Ø 100	393	ml
1H5X12	Ø 120	566	ml
1H5X14	Ø 140	770	ml
1H5X16	Ø 160	1005	ml
1H5X18	Ø 180	1272	ml
1H5X20	Ø 200	1571	ml
1H5X22	Ø 220	1901	ml
1H5X24	Ø 240	2262	ml
1H5X26	Ø 260	2655	ml
1H5X28	Ø 280	3079	ml
1H5X30	Ø 300	3534	ml

ROUND



H. 40 mm

1H4X8	Ø 80	202	ml
1H4X10	Ø 100	314	ml
1H4X12	Ø 120	452	ml
1H4X14	Ø 140	616	ml
1H4X16	Ø 160	804	ml
1H4X18	Ø 180	1018	ml
1H4X20	Ø 200	1257	ml
1H4X22	Ø 220	1521	ml
1H4X24	Ø 240	1810	ml
1H4X26	Ø 260	2124	ml
1H4X28	Ø 280	2463	ml
1H4X30	Ø 300	2827	ml

H. 35 mm

1H35X14	Ø 140	539	ml
1H35X16	Ø 160	704	ml
1H35X18	Ø 180	891	ml
1H35X20	Ø 200	1100	ml
1H35X22	Ø 220	1330	ml
1H35X24	Ø 240	1583	ml

H. 30 mm

1H3X10	Ø 100	150	ml
1H3X18	Ø 180	848	ml

H. 25 mm

1H25X14	Ø 140	385	ml
1H25X16	Ø 160	503	ml
1H25X18	Ø 180	636	ml
1H25X20	Ø 200	785	ml
1H25X22	Ø 220	950	ml
1H25X24	Ø 240	1131	ml

H. 20 mm

1H2X8	Ø 80	101	ml
1H2X10	Ø 100	157	ml
1H2X12	Ø 120	226	ml
1H2X14	Ø 140	308	ml
1H2X16	Ø 160	402	ml
1H2X18	Ø 180	509	ml
1H2X20	Ø 200	628	ml
1H2X22	Ø 220	760	ml
1H2X24	Ø 240	905	ml
1H2X26	Ø 260	1062	ml
1H2X28	Ø 280	1232	ml

pastry RING

SQUARE

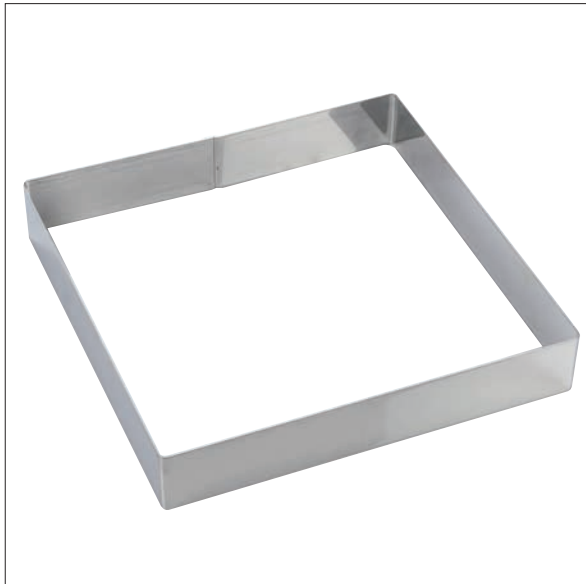

H. 60 mm

5H6X6	60 x 60	216 ml
5H6X8	80 x 80	384 ml
5H6X10	100 x 100	600 ml
5H6X12	120 x 120	3744 ml

H. 50 mm

5H5X10	102 x 102	520 ml
5H5X12	122 x 122	744 ml
5H5X14	142 x 142	1008 ml
5H5X16	162 x 162	1312 ml
5H5X18	182 x 182	1656 ml
5H5X20	202 x 202	2040 ml
5H5X22	222 x 222	2464 ml
5H5X24	242 x 242	2928 ml
5H5X26	262 x 262	812 ml
5H5X28	282 x 282	3976 ml
5H5X30	302 x 302	4560 ml

H. 40 mm

5H4X10	102 x 102	416 ml
5H4X12	122 x 122	595 ml
5H4X14	142 x 142	807 ml
5H4X16	162 x 162	1050 ml
5H4X18	182 x 182	1325 ml
5H4X20	202 x 202	1632 ml
5H4X22	222 x 222	1971 ml
5H4X24	242 x 242	2343 ml
5H4X26	262 x 262	650 ml
5H4X28	282 x 282	3181 ml
5H4X30	302 x 302	3648 ml

H. 35 mm

5H35X14	142 x 142	706 ml
5H35X16	162 x 162	913 ml
5H35X18	182 x 182	1159 ml

H. 25 mm

5H25X14	142 x 142	504 ml
5H25X16	162 x 162	652 ml
5H25X18	182 x 182	828 ml

OVAL

H. 40 mm

2H4X12	135 x 100	429 ml
2H4X14	160 x 120	610 ml
2H4X16	185 x 135	796 ml
2H4X18	205 x 155	1009 ml
2H4X20	225 x 175	1248 ml
2H4X22	253 x 190	1528 ml
2H4X26	300 x 220	2102 ml
2H4X28	320 x 250	2535 ml
2H4X30	345 x 260	2850 ml

DROP

H. 40 mm

8H4X10	128 x 82	273 ml
8H4X12	156 x 100	391 ml
8H4X14	176 x 115	511 ml
8H4X16	206 x 127	650 ml
8H4X18	226 x 146	831 ml
8H4X20	251 x 165	1049 ml
8H4X22	271 x 180	1240 ml
8H4X24	300 x 196	1490 ml
8H4X26	325 x 210	1724 ml
8H4X28	330 x 255	1986 ml
8H4X30	355 x 270	2315 ml

HEXAGONAL

H. 50 mm

3H5X7	121 x 140	637 ml
3H5X8	139 x 160	831 ml
3H5X10	173 x 200	1299 ml
3H5X12	208 x 240	1871 ml
3H5X14	242 x 280	2546 ml

H. 40 mm

3H4X7	120 x 140	509 ml
3H4X8	140 x 160	665 ml
3H4X10	175 x 200	1039 ml
3H4X11	195 x 220	1257 ml
3H4X12	210 x 240	1497 ml
3H4X13	235 x 255	1756 ml
3H4X14	245 x 280	2037 ml

pastry RING



RECTANGULAR



H. 50 mm

11H5L24	240 x 142	1704	ml
11H5L26	263 x 164	2157	ml
11H5L28	282 x 183	2580	ml
11H5L30	302 x 222	3352	ml
11H5L36	360 x 165	2970	ml
11H5L38	382 x 262	5004	ml
11H5L39	390 x 80	1751	ml
11H5L40	403 x 320	6448	ml

H. 40 mm

11H4L24	243 x 142	1380	ml
11H4L26	263 x 164	1725	ml
11H4L28	282 x 183	2064	ml
11H4L30	302 x 222	2682	ml
11H4L36	360 x 165	2376	ml
11H4L38	382 x 262	4003	ml
11H4L39	390 x 80	1248	ml
11H4L40	403 x 320	5158	ml

BIG RECTANGULAR

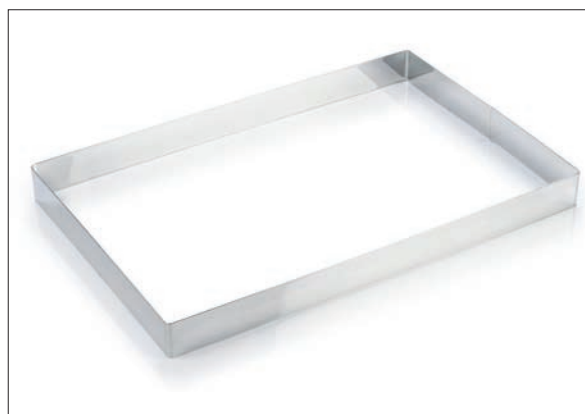

H. 50 mm

RETH5	380 x 580	11020	ml
11H5L56	560 x 360	8280	ml
11H5L59	595 x 395	11751	ml

H. 40 mm

RETH4	380 x 580	8816	ml
11H4L56	460 x 360	6624	ml
11H4L59	595 x 395	9401	ml

FANCY



H. 50 mm

23H5X25	250 x 90	1125	ml
23H5X30	300 x 91	1365	ml
23H5X35	350 x 92	1610	ml

H. 40 mm

23H4X25	250 x 90	900	ml
23H4X30	300 x 91	1092	ml
23H4X35	350 x 92	1288	ml

SPECIAL

Telaio regolabile in lunghezza ed in larghezza.
Extendable st. steel frame, length and width adjustable.

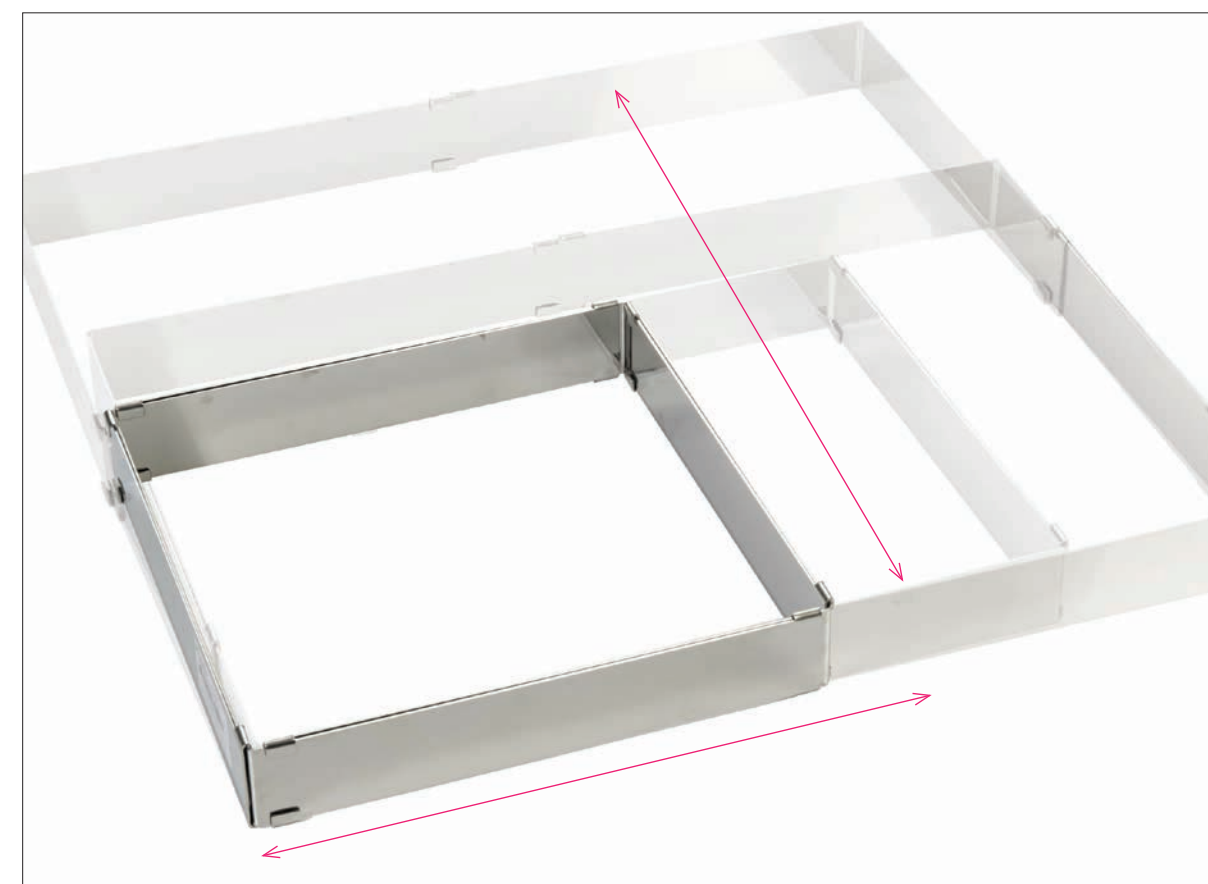

H. 50 mm

RETSPECIAL 1 min. 305 x 305 - max 570 x 560

H. 40 mm

RETSPECIAL 2 min. 305 x 305 - max 570 x 560

Easter

EGG

H. 40 mm

27H4X12	121 x 180	667 ml
27H4X13	134 x 200	823 ml
27H4X14	148 x 220	997 ml
27H4X16	161 x 240	1184 ml



DOVE

H. 40 mm

15H4X25	236 x 132	840 ml
15H4X30	283 x 160	1209 ml
15H4X34	320 x 180	1560 ml



Christmas

TREE

H. 40 mm

14H4X16	153 x 128	371 ml
14H4X20	208 x 141	552 ml
14H4X24	245 x 180	950 ml
14H4X30	300 x 235	1408 ml

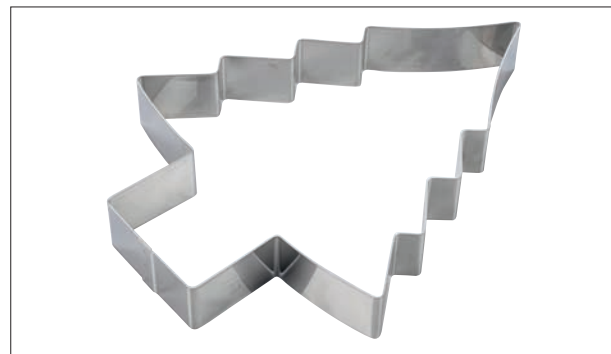

COMET

H. 40 mm

13H4X15	158 x 68	245 ml
13H4X23	248 x 98	531 ml
13H4X30	320 x 133	882 ml

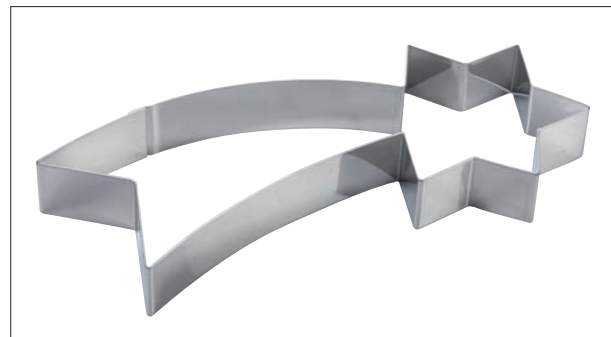

FOOD PLATING

ROUND

H. 60 mm

70H602 kit 2 pcs Ø 100 - 120

H. 40 mm

70H402 kit 2 pcs Ø 100 - 120

SQUARE

H. 60 mm

71H602 kit 2 pcs 100 x 100 - 120 x 120

H. 40 mm

71H402 kit 2 pcs 100 x 100 - 120 x 120





H. 30 mm

Number	Size H.300 mm	Cod. Code	Cap. ml
0	300x160h40	40H4X10	1900
1	300x93 h 40	40H4X01	1200
2	300x160h40	40H4X02	1800
3	300x160h40	40H4X03	1650
4	300x170h40	40H4X04	1750
5	300x160h40	40H4X05	1800
6	300x160h40	40H4X06	1950
7	300x160h40	40H4X07	1350
8	300x160h40	40H4X08	2000
9	300x160h40	40H4X09	1950



H. 20 mm

Number	Size H.200 mm	Cod. Code	Cap. ml
0	200x160h40	30H4X10	850
1	200x93 h 40	30H4X01	520
2	200x160h40	30H4X02	800
3	200x160h40	30H4X03	740
4	200x170h40	30H4X04	780
5	200x160h40	30H4X05	800
6	200x160h40	30H4X06	870
7	200x160h40	30H4X07	600
8	200x160h40	30H4X08	900
9	200x160h40	30H4X09	870

SPECIALE NATALE
CHRISTMAS SPECIAL

Stampi pandoro in alluminio 10/10
Aluminium 10/10 pandoro moulds

- 250 gr
30SP0250
Ø 16,5 h 13 cm
- 500 gr
30SP0500
Ø 19,5 h 14,5 cm
- 750 gr
30SP0750
Ø 20,5 h 15,5 cm
- 1000 gr
30SP1000
Ø 23 h 17 cm



Stampo Casetta di Natale
Gingerbread House Cutter
30CH001
Acciaio inox - Stainless steel
120x138 h 140mm



GHIERA PER LIEVITATI

Realizzata con punte in acciaio inox, è adatta al contatto alimentare.
Di facile impilamento sia su carrelli che su rastrelliere murali.
Perfetto ancoraggio con tutti i tipi di stampi (colombe-stelle-cake-alberi etc..).
Impugnatura salda e sicura.
Ghiera in acciaio inox che permette una chiusura ottimale.

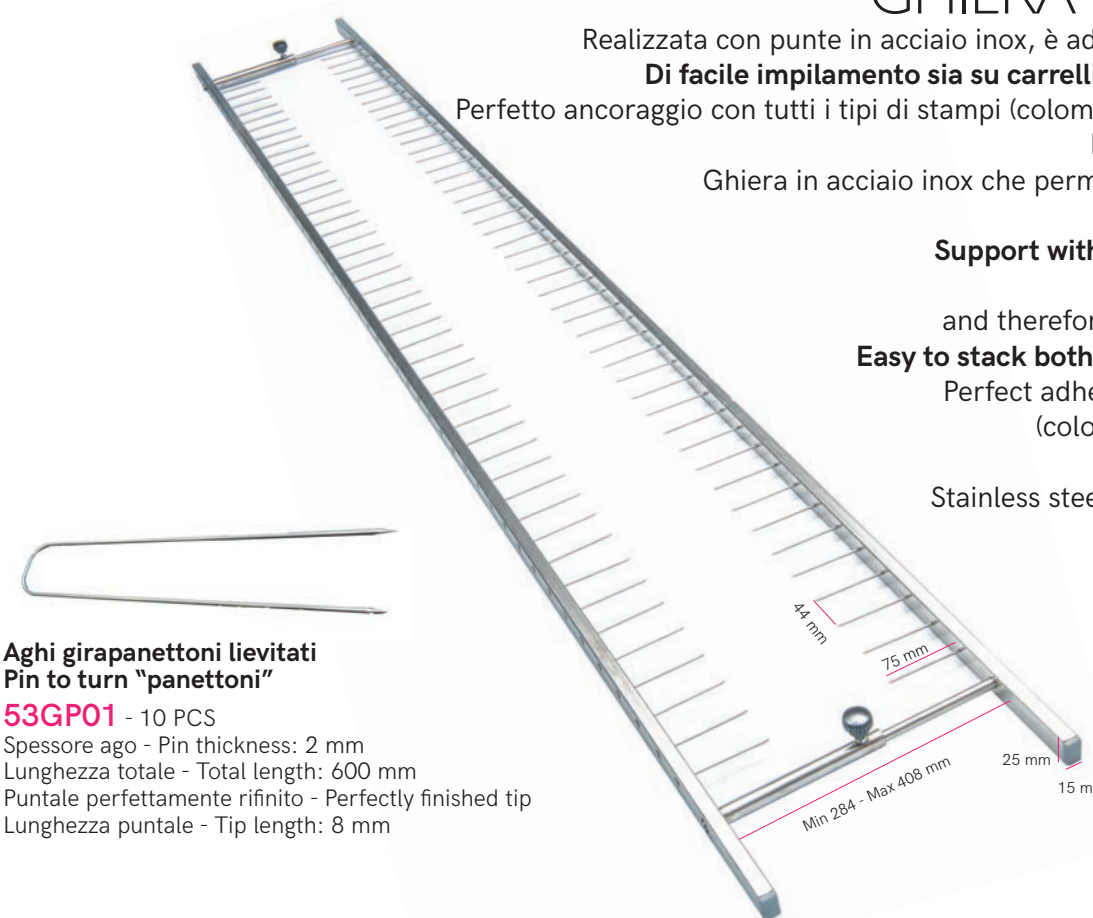

Aghi girapanettoni lievitati
Pin to turn "panettoni"
53GP01 - 10 PCS
Spessore ago - Pin thickness: 2 mm
Lunghezza totale - Total length: 600 mm
Puntale perfettamente rifinito - Perfectly finished tip
Lunghezza puntale - Tip length: 8 mm

Support with nails for leavened doughs
Tips made of stainless steel and therefore suitable for food contact.
Easy to stack both on trolleys and wall racks.
Perfect adhesion on all types of moulds (colombe-stars-cake-trees etc..)
Firm and safe grip.
Stainless steel nail for optimal fastening.

50GIRA02
Asse girapanettoni
"Panettoni" cake turning rod
Acciaio inox - Stainless steel
Lunghezza - Total size: 221 cm
Aghi fissi - fixed pins Ø2,7 mm

LE COMPONENTI INOX

CAKE IDEA presenta un nuovo concetto di componibilità verticale, per consentire ai pasticceri più innovativi e creativi di offrire torte multigusto e multiconsistenza, sempre più sorprendenti, con preparazioni semplici e veloci. Gli stampi permetteranno una costruzione stratificata del dolce, grazie alla presenza di un top essenziale per la creazione con diverse consistenze e che funge anche da elemento decorativo, permettendo giochi di volumi.

CAKE IDEA presents a new concept of vertical modularity, to allow the most innovative and creative confectioners to offer multi-flavoured and multiconsistency cakes, more and more surprising, with simple and quick preparations. The moulds will allow a layered construction of the cake, thanks to the presence of a top essential for creating with different consistencies and which also acts as a decorative element, allowing games of volumes.



Gli stampi dei CAMPIONI DEL MONDO
CAKE IDEA è stata protagonista dell'edizione 2020 della Coppa del Mondo della Gelateria. Le squadre in gara si sono contestate il titolo di Campioni del Mondo con le ultime novità del sistema di fasce inox componibili, grazie alle quali è possibile dare forma alla creatività.

The moulds of the WORLD CHAMPIONS
CAKE IDEA was the protagonist of the 2020 edition of the Ice Cream World Cup. The participating teams competed for the title of World Champion with the latest innovations in the system of modular stainless steel bands, thanks to which it is possible to give shape to creativity.



ELLIPSE

52KIT27
KIT COMPONENTI
Pack 3 pcs
Base: 27x12 h3 cm
Insert: 25x10 h2 cm
Top: 23x8 h2 cm
Cap. 1100 ml



4 TASTE

38H4X22S
4 Moulds: 10x10 h4 cm
Pack 4 pcs
Cap. 1600ml

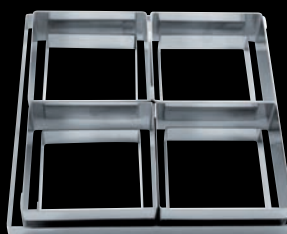

4 TASTE KIT

38KITH4X22
Pack 9 pcs
4 Insert: 8x8 h2 cm
4 Moulds: 10x10 h4 cm
1 Base: 22x22 h2 cm
Cap. 1600ml

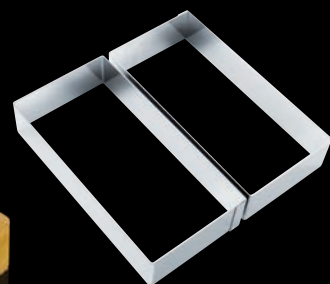

DOUBLE

37H4X22S
2 Moulds: 10x20 h4 cm
Pack 2 pcs
Cap. 1600ml

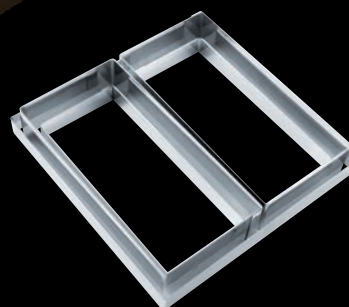

DOUBLE KIT

37KITH4X22
Pack 5 pcs
2 Insert: 18x8 h2 cm
2 Moulds: 10x20 h4 cm
1 Base: 22x22 h2 cm
Cap. 1600ml

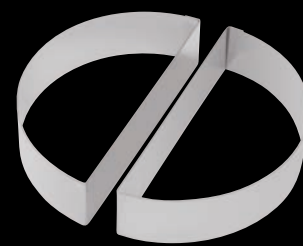

DEMI 18

39H4X20S
Mould: Ø18 h4 cm
Pack 2 pcs
Cap. 985ml



39KITH4X20

KIT COMPONENTI
Pack 6 pcs
Insert: Ø16 h2 cm
Mould: Ø18 h4 cm
Base: Ø20 h2 cm
Cap. 985ml

DEMI 22

39H4X24S
Mould: Ø22 h4 cm
Pack 2 pcs
Cap. 1473ml

39KITH4X24

KIT COMPONENTI
Pack 6 pcs
Insert: Ø20 h2 cm
Mould: Ø22 h4 cm
Base: Ø24 h2 cm
Cap. 1473ml



MOON

36H4X22S
2 Moulds: Ø20 h4 cm
Pack 2 pcs
Cap. 1100ml



MOON KIT

36KITH4X22
Pack 5 pcs
2 Inserts: Ø28 h2 cm
2 Moulds: Ø20 h4 cm
1 Base: Ø22 h2 cm
Cap. 1100ml





DUETTO 19

33H4X20S
2 Moulds: Ø19 h4 cm
Pack 2 pcs
Cap. 950ml

DUETTO 23

33H4X24S
2 Moulds: Ø23 h4 cm
Pack 2 pcs
Cap. 1400ml

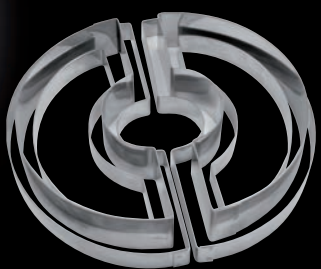

DUETTO 19 KIT

33KITH4X20
2 Insert: Ø17 h2 cm
2 Moulds: Ø19 h4 cm
2 Base: Ø22 h2 cm
Cap. 950ml

DUETTO 23 KIT

33KITH4X24
2 Insert: Ø21 h2 cm
2 Moulds: Ø23 h4 cm
2 Base: Ø25 h2 cm
Cap. 1400ml



HEART 14

35H4X14S
2 Moulds: 14x14 h4 cm
Pack 2 pcs
Cap. 530ml

HEART 19

35H4X19S
2 Moulds: 19x19 h4 cm
Pack 2 pcs
Cap. 1000ml



HEART 19 KIT

35KITH4X19
2 Insert: 15x8 h2 cm
2 Moulds: 19x19 h4 cm
Cap. 1000ml



TWINS 16

34H4X16S
2 Moulds: 16x16 h4 cm
Pack 2 pcs
Cap. 950ml

TWINS 20

34H4X20S
2 Moulds: 20x20 h4 cm
Pack 2 pcs
Cap. 1400ml



TWINS 16 KIT

34KITH4X16
2 Insert: 13x13 h2 cm
2 Moulds: 16x16 h4 cm
2 Base: 17x17 h2 cm
Cap. 950ml

TWINS 20 KIT

34KITH4X20
2 Insert: 16x16 h2 cm
2 Moulds: 20x20 h4 cm
2 Base: 24x24 h2 cm
Cap. 1400ml



TRILOGY 18

32H4X18S
3 Moulds: Ø18 h4 cm
Pack 3 pcs
Cap. 950ml

TRILOGY 22

32H4X22S
3 Moulds: Ø22 h4 cm
Pack 3 pcs
Cap. 1400ml



CLASSIC SYSTEM

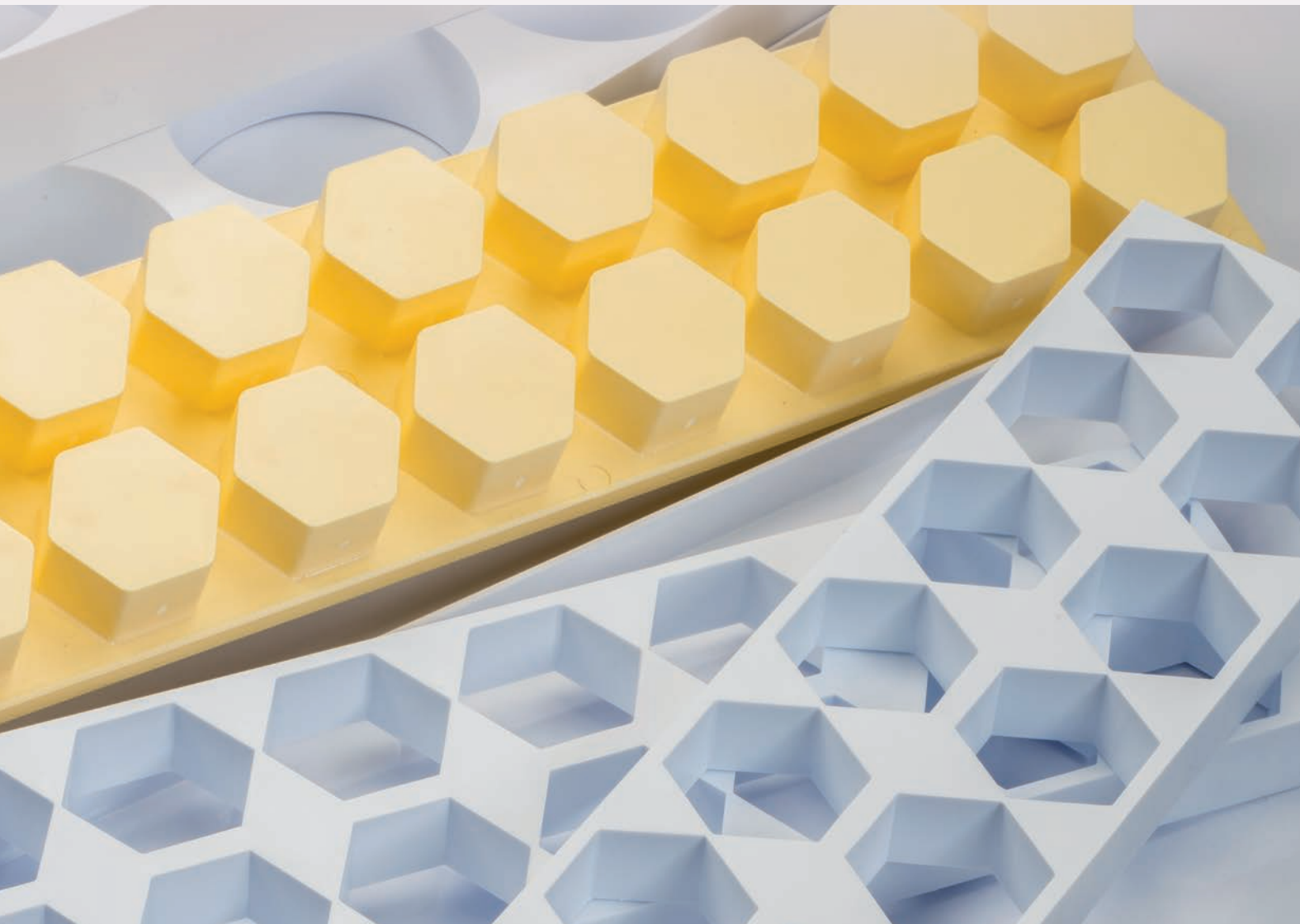

Barre in plastica per la produzione, sia dolce che salata, di monoporzioni e mignon. Il materiale rigido conferisce stabilità per una maggior precisione nella preparazione e maneggevolezza durante la lavorazione. Facili da riempire, anche senza teglia, e da spatolare per la chiusura. L'estrazione risulta facile anche con il prodotto non completamente congelato e grazie all'acetato non sarà necessario glassare.

Plastic bars for the production, both sweet and savoury, of single portions and mignons. The rigid material gives stability for greater precision in preparation and handling during processing. Easy to fill, even without baking tray, and to spatulate for closing. Extraction is easy even when the product is not completely frozen and thanks to acetate there is no need to glaze.



Kit completo
Complete kit

L'articolo include vassoio e barre
The article includes tray and bars

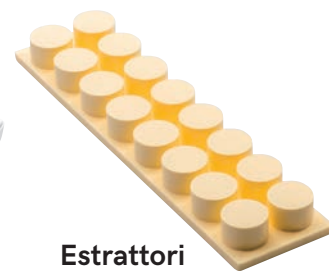

Estrattori
Extractors

Non inclusi
Not included



Tagliapasta
Cutters

Non inclusi
Not included



MIGNON



Prod.	Codice - Code	Extractor	Cutter
32	MIGNON A001	ED 1	TPM 1
48	MIGNON B001	ED 1	TPM 1
96	MIGNON C001	ED 1	TPM 1



Prod.	Codice - Code	Extractor	Cutter
32	MIGNON A002	ED 2	TPM 2
48	MIGNON B002	ED 2	TPM 2
96	MIGNON C002	ED 2	TPM 2



Prod.	Codice - Code	Extractor	Cutter
32	MIGNON A003	ED 3	TPM 3
48	MIGNON B003	ED 3	TPM 3
96	MIGNON C003	ED 3	TPM 3



Prod.	Codice - Code	Extractor	Cutter
32	MIGNON A005	ED 5	TPM 5
48	MIGNON B005	ED 5	TPM 5
96	MIGNON C005	ED 5	TPM 5



Prod.	Codice - Code	Extractor	Cutter
32	MIGNON A007	ED 7	TPM 7
48	MIGNON B007	ED 7	TPM 7
96	MIGNON C007	ED 7	TPM 7



Prod.	Codice - Code	Extractor	Cutter
32	MIGNON A009	ED 9	TPM 9
48	MIGNON B009	ED 9	TPM 9
96	MIGNON C009	ED 9	TPM 9

MIGNON A
20X40CM
2 Barre/Moulds
32 mignon

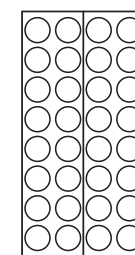

MIGNON B
30X40CM
3 Barre/Moulds
48 mignon

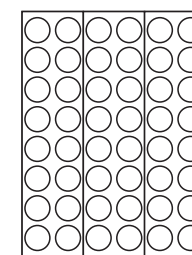

MIGNON C
60X40CM
6 Barre/Moulds
96 mignon

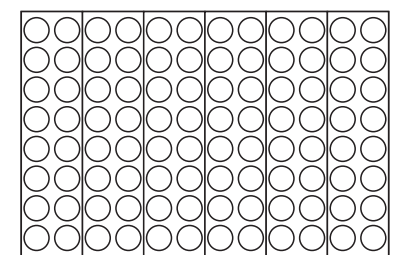



INDIVIDUAL DESSERT

CIRCLE
 Ø65 h.40 mm
 CAP. 133 ML

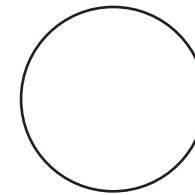

CIRCLE
 Ø60 h 45 mm
 CAP. 127 ML

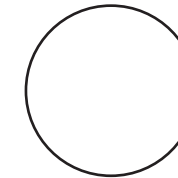

OVAL
 87x51 h 40 mm
 CAP. 139 ML

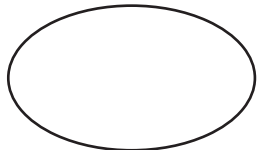

Prod.	Codice - Code	Extractor	Cutter
10	MONOP. A001	EM 1	TPG 1
15	MONOP. B001	EM 1	TPG 1
35	MONOP. C001	EM 1	TPG 1

Prod.	Codice - Code	Extractor	Cutter
10	MONOP. A1	EM 01	TPG 01
15	MONOP. B1	EM 01	TPG 01
35	MONOP. C1	EM 01	TPG 01

Prod.	Codice - Code	Extractor	Cutter
10	MONOP. A002	EM 2	TPG 2
15	MONOP. B002	EM 2	TPG 2
35	MONOP. C002	EM 2	TPG 2

SQUARE
 59x59 h 40 mm
 CAP. 139 ML



HEART
 78,5x72,5 h 40 mm
 CAP. 143 ML

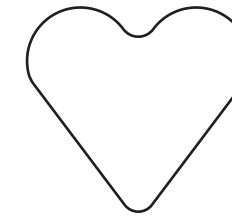

DROP
 89x57,5 h 40 mm
 CAP. 138 ML

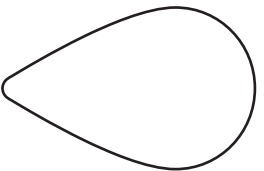

Prod.	Codice - Code	Extractor	Cutter
10	MONOP. A005	EM 5	TPG 5
15	MONOP. B005	EM 5	TPG 5
35	MONOP. C005	EM 5	TPG 5

Prod.	Codice - Code	Extractor	Cutter
10	MONOP. A007	EM 7	TPG 7
15	MONOP. B007	EM 7	TPG 7
35	MONOP. C007	EM 7	TPG 7

Prod.	Codice - Code	Extractor	Cutter
10	MONOP. A008	EM 8	TPG 8
15	MONOP. B008	EM 8	TPG 8
35	MONOP. C008	EM 8	TPG 8

COMMA
 92x60 h 40 mm
 CAP. 143 ML

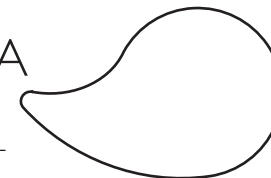

OBLONG
 94x38 h 40 mm
 CAP. 130 ML



Prod.	Codice - Code	Extractor	Cutter
10	MONOP. A009	EM 9	TPG 9
15	MONOP. B009	EM 9	TPG 9
35	MONOP. C009	EM 9	TPG 9

Prod.	Codice - Code	Extractor	Cutter
10	MONOP. A0013	EM 13	TPG 13
15	MONOP. B0013	EM 13	TPG 13
35	MONOP. C0013	EM 13	TPG 13

MONOP. A
 17X40CM
 2 Barre/Moulds
 10 monoportion

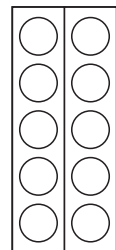

MONOP. B
 26X40CM
 3 Barre/Moulds
 15 monoportion

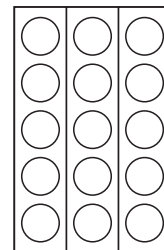

MONOP. C
 60X40CM
 7 Barre/Moulds
 35 monoportion

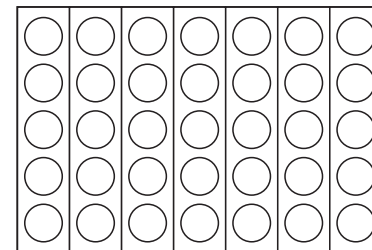

Kit completo
Complete kit

L'articolo include vassoio e barre
 The article includes tray and bars



Estrattori
Extractors

Non inclusi
 Not included



Tagliapasta
Cutters

Non inclusi
 Not included



CAKE SLICE

SLICE 150 ML
117x62 h 40 mm



Prod.	Codice - Code	Extractor	Cutter
8	MONOP. A0016	EM 16	TPG 16
12	MONOP. B0016	EM 16	TPG 16
28	MONOP. C0016	EM 16	TPG 16

12 fette/slices = 1 torta/cake Ø24cm
L'articolo include vassoio e barre
The article includes tray and bars



SPECIAL SIZE

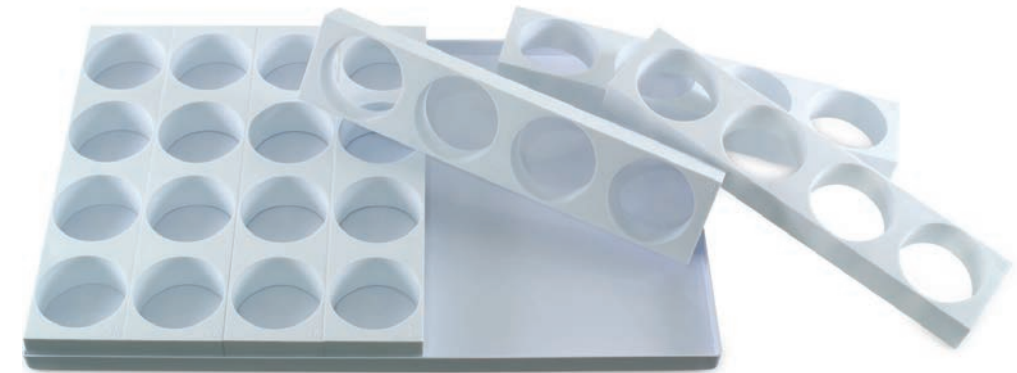

Stampi per **monoporzioni extra size** per rispondere alle esigenze di misure diverse dall'ordinario. L'articolo include vassoio 60x40 cm e 7 barre.

Moulds for extra-size single-portion to meet the needs of non-standard sizes.
The item includes 60x40 cm tray and 7 bars.
Prod. 28 dolci / cake

ml	mm	h mm	Cod.	Cutter
200	Ø 80	40	EXTRA C	TPEX 1



Stampi per pratici **mini cake biporzione** adatti alle richieste delle moderne tendenze.
L'articolo include vassoio 60x40 cm e 5 barre.

Moulds for practical mini double portion cakes suitable for modern trends' demands.
The article includes 60x40 cm tray and 5 moulds
Prod. 15 dolci / cake

ml	mm	h mm	Cod.	Cutter
350	Ø 100	45	MONOP. C101	TPB1

ACETATI - ACETATE

Extra trasparenti, super resistenti, prodotti con materiale di alta qualità. Facili da usare per rivestire stampi e per realizzare e sformare monoporzioni e mignon. Antiaderenti per uso alimentare. Adatti al raffreddamento in abbattitore, congelatore e frigo, ma non adatti alla cottura.

Extra-clear, super-strong, made of high-quality material. Easy to use for coating moulds and for making and unmoulding monoportions and mignons. Non-stick for food use. Suitable for cooling in blast chillers, freezers and fridges, but not suitable for baking.

NASTRI - RIBBONS



h (mm)	Codice - Code	h (mm)	Codice - Code
h 25	NSA H 25	h 45	NSA H 45
h 30	NSA H 30	h 50	NSA H 50
h 35	NSA H 35	h 55	NSA H 55
h 40	NSA H 40	h 60	NSA H 60

Specifiche / features

spessore / thickness
80 my

lunghezza
length 305 mt



anima / core
Ø 70 mm

misura esterna
external size
Ø 210 mm

Il materiale multistrato con il quale sono realizzati i nostri nastri proviene parzialmente da plastica riciclata. La loro speciale composizione li rendono ideali al contatto alimentare e rispettosi dell'ambiente.

The multi-layer material with which our ribbons are made comes partly from recycled plastic. Their special composition makes them suitable for food contact and environment-friendly.



Tutti i rotoli sono adatti alla taglianastri
All ribbons are suitable for ribbon cutter

50MC001

**MART
CUTTER**
AUTOMATIC RIBBON CUTTER



FOGLI CHITARRA - GUITAR SHEETS



Ideali per creare decorazioni di cioccolato, trasferiscono lucentezza al prodotto finito e facilitano il distacco.
Ideal for creating chocolate decorations as they transfer shine to the finished product and facilitate the detachment.

NSA60X40MO
590X390 mm
Pack 50 pcs - 120 my

NSA39X39MO
390x390 mm
Pack 100 pcs - 75 my

NSA27X27MO
270x270 mm
Pack 100 pcs - 75 my
ideal for 50TLMINI

FOGLI - SHEETS



80 my - 50 pcs
Disponibili altre misure e spessori su richiesta.
On request other sizes and thicknesses.

NSA400X600
388x588 mm

NSA300X300
300x300 mm

STRISCE - STRIPS

90 my - 1000 pcs

NSA30X240
h 30x240 mm

NSA40X240
h 40x240 mm

NSA25X150
h 25x150 mm





LA TRADIZIONE CREA LA MODERNITÀ

Combinare gli elementi per dare vita a monoporzioni che, giocando con le proporzioni dei sapori, creano nuove armonie di gusto. Nasce con questo intento un progetto di dessert, pensato per la ristorazione, ma perfetto per la pasticceria moderna, che utilizzando semplici attrezzature consente risultati di alto livello.

Monoporzioni che accostano gusti, consistenze e colori per stimolare la voglia di assaggiare dei clienti, combinandoli a misure e forme diverse.

TRADITION CREATES MODERNITY

Combining the elements to give life to single portions that, playing with the proportions of flavors, create new harmonies of taste. With this intent a dessert project was born, designed for catering, but perfect for modern pastry making, which by using simple equipment allows high level results.

Monoportions that combine flavors, textures and colors to stimulate customers' desire to taste, combining them with different sizes and shapes.



Circle

30IDEA01

Ø83 h 25mm ~ 130ml
Prod. 12 pcs
3 barre-bars + 1 estrattore-extractor



Tagliapasta - Cutter

TPIDEA01

2 pcs - 2 sizes



Rectangle

30IDEA02

62x48 h 25mm ~ 70ml
Prod. 18 pcs
3 barre-bars + 1 estrattore-extractor



Tagliapasta - Cutter

TPIDEA02

2 pcs - 2 sizes



Log

30IDEA03

118x47 h 25mm ~ 130ml
Prod. 9 pcs
3 barre-bars + 1 estrattore-extractor



Tagliapasta - Cutter

TPIDEA03

2 pcs - 2 sizes



Triangle

30IDEA04

42x38 h 25mm ~ 25ml
Prod. 48 pcs
3 barre-bars + 1 estrattore-extractor



Dot

30IDEA05

Ø35 h 25mm ~ 25ml
Prod. 48 pcs
3 barre-bars + 1 estrattore-extractor



Square

30IDEA06

31,5x31,5 h 25mm ~ 25ml
Prod. 48 pcs
3 barre-bars + 1 estrattore-extractor

Ogni confezione comprende:
3 barre ed 1 estrattore.



EASY LOG

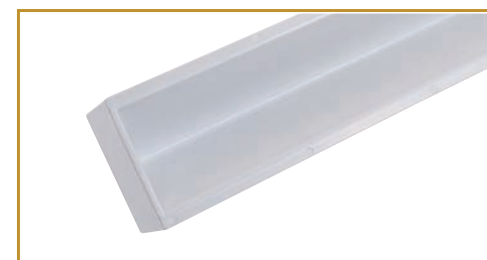

CLASSIC



30TT104S
400x100 - h60 mm



DOME



ST2
480x65 - h50 mm

ST4
480x50 - h40 mm

ACCESSORI - ACCESSORIES



Stampi per inserti/Moulds for inserts

30TB3S

Kit 2 stampi plastica/2 plastic moulds kit
35x180 h30 mm



Pralina Stella **MA1984**

Polycarbonate mould
40x42 h16 mm
15 pcs ~ 10 gr

SEMIFREDDO MATS

360x163 mm
FOR CLASSIC MOULD



I tappeti in silicone sapranno arricchire i vostri tronchetti.
Il materiale rende possibile un'ottimale sformatura del semifreddo donando al dessert decori di grande effetto.

The silicone mats will enrich your log-shaped dessert.
The material features ensure easy removal of the semifreddo from the mould, creating impressive decorations.

LISCIO/SMOOTH
30TS000



ARABIC
30TS001



FLOREAL
30TS002



O'CLOCK
30TS003



MEDIEVAL
30TS005

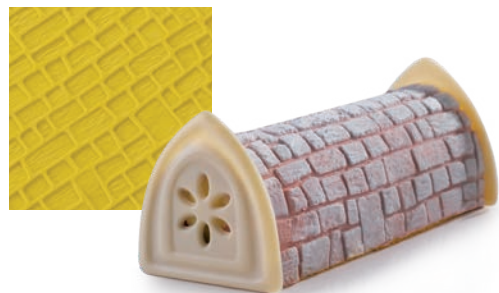

STONE
30TS006

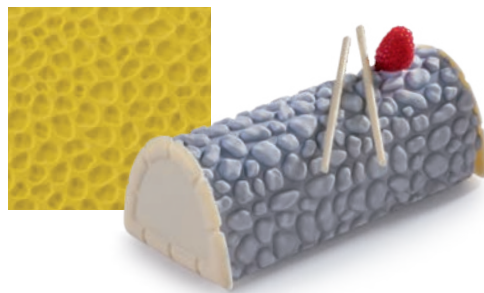

WAVES
30TS007



HOLLY
30TS008



SNOWFLAKE
30TS009



COMET
30TS010



BRICK
30TS012

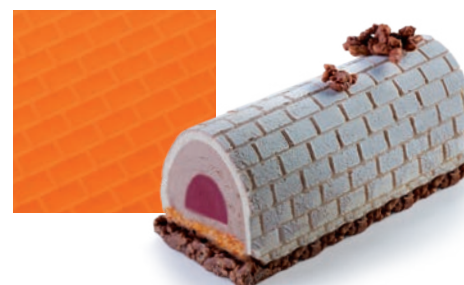

QUADRI
30TS016



DECORATIONS

Kit 2 plastic moulds to realize 12 decorations

ARABIC
20TES001



FLOREAL
20TES002



FLOWER
20TES004



MEDIEVAL
20TES005



STONE
20TES006



WAVES
20TES007



ICE CREAM

Ice Tube

Lo stampo best seller per rinfrescare l'estate. Con Ice Tube si ottengono splendidi ghiaccioli da esporre in vetrina per ingolosire i clienti e da consegnare loro come contenitore. Riutilizzabili e lavabili in lavastoviglie: 50 lavaggi, 100% riciclabile, BPA free.

The best seller mould to refresh the summer. With Ice Tube you can obtain wonderful icicles to display in the window to tempt customers and to give them as a container. Reusable and dishwasher safe: 50 washes, 100% recyclable, BPA free.



Ice tube
CLP01
100 pcs ~150 ml
Ø53 x 174 mm

PLEXIGLASS DISPLAYS



Supporto plastica bianca per abbattitore
White plastic holder for blast chiller
CLPESPOB
290x390 h120 mm
28 sedi - holes



Espositore trasparente vetrina verticale
Transparent display for vertical cabinets
CLPESPOBTRA
280x360 h120 mm
25 sedi - holes



Espositori satinati per vetrina gelato
Satin-finish displays for standard ice-cream
CLPESPO21
250x360 h45 mm
21 sedi - holes

STECCO MOULDS



Stampo in **silicone alimentare** per dolci da passeggio a forma di lingotto. Proposto con due diverse grammature consente di produrre gelati e mini snack, ricoperti per diventare ancora più golosi.

Food grade silicone mould for ice creams on stick in the shape of an ingot. Proposed with two different weights allows you to produce ice cream and mini snacks, that once covered become even more delicious.



BRICK

104002

Ice cream: 35 x 25 h 93 mm
 Prod. 12 pcs - Weight ~ 74 ml
 2 Stampi/moulds 390 x 146 mm
 Vassoio/tray 410 x 305 mm
 50 Bastoncini/sticks



DISPLAY

10E007

370x230 h 50 mm - Cap. 24 pcs
 Ideal for Brick

10E006

370x235 h 39 mm - Cap. 40/48 pcs
 Ideal for Brick Mini

BRICK MINI

104003

Ice cream: 26,5 x 21 h 70 mm
 Prod. 16 pcs - Weight ~ 35 ml
 2 Stampi/moulds 390 x 118 mm
 Vassoio/tray 410 x 255 mm
 50 Bastoncini/sticks



STICKS

10SL114

9,5 h 114 mm - 500 pcs
 Ideal for Brick

10SL072

8 h 72 mm - 500 pcs
 Ideal for Brick Mini

STECCO MOULDS

Lo **stampo in silicone** perfetto per realizzare ricoperti o semplici gelati su stecco.
La sua forma classica e lineare consente di creare infinite proposte, sia dolci che salate.

Classic silicone mould to prepare covered or simple ice creams on a stick.
Its linear shape allows to create endless proposals, both sweet and savory.



CLASSIC

104000

Ice-cream: 44x22 h 93 mm
Prod: 12 pcs - 80 ml

2 Stampi/Moulds 390x146 mm
Vassoio/Tray 410x310 mm
50 Bastoncini/Sticks

CLASSIC MINI

104001

Ice-cream: 33x18 h 69 mm
Prod: 16 pcs - 35 ml

2 Stampi/Moulds 390x118 mm
Vassoio/Tray 410x255 mm
50 Bastoncini/Sticks



DISPLAY

10E007

370x230 h 50 mm - Cap. 24 pcs
Ideal for Classic

10E006

370x235 h 39 mm - Cap. 40/48 pcs
Ideal for Classic Mini

STICKS

10SL114

9,5 h 114 mm - 500 pcs
Ideal for Classic

10SL072

8 h 72 mm - 500 pcs
Ideal for Classic Mini



GhiaccioloFlex

La rivoluzione dedicata alla produzione artigianale di ghiaccioli su stecco. Lo straordinario materiale plastico utilizzato per la sua produzione lo rende particolarmente flessibile e assolutamente indeformabile.

The revolution dedicated to the artisan production of ice lollies on stick. The extraordinary plastic material selected and used for its production makes it absolutely non-deformable and particularly flexible.



WAVE

105000

86 ml

49x22 h 125 mm

Prod: 24 pcs ~ 80/85 gr



RECOUVERT

105002

90 ml

56x33 h 102 mm

Prod: 24 pcs ~ 80/85 gr



TWIG

105003

90 ml

Ø35 h 100 mm

Prod: 24 pcs ~ 80/85 gr

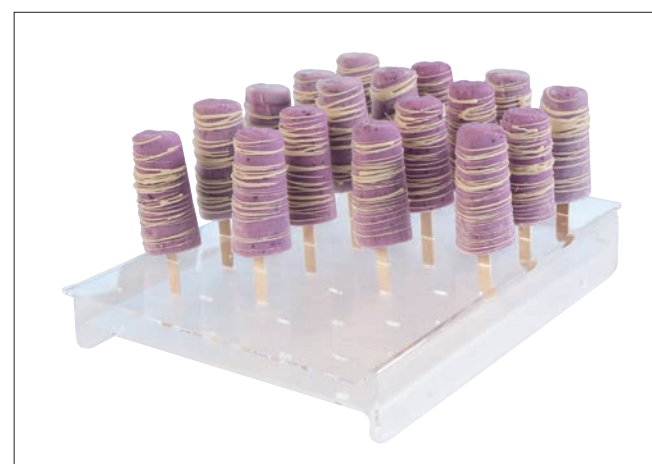

Espositore in plexiglass per vetrina orizzontale
Plexiglass display for horizontal showcases

10-E002

Misura - Size: 360x250 h50mm

Cap. 24 pcs

Baby Ice®

Un ottimale connubio di simpatia delle forme e genuinità degli ingredienti che solo la vera produzione artigianale può offrire. Grazie agli stampi in plastica a forma di animali si potranno produrre coloratissimi e freschissimi ghiaccioli. Lavabili in lavastoviglie e riutilizzabili.

The perfect mix of funny shapes and genuine ingredients that can be provided only by artisan production. A kit of plastic moulds to produce colorful and fresh animal shaped ice lollies. Reusable and dishwasher safe.

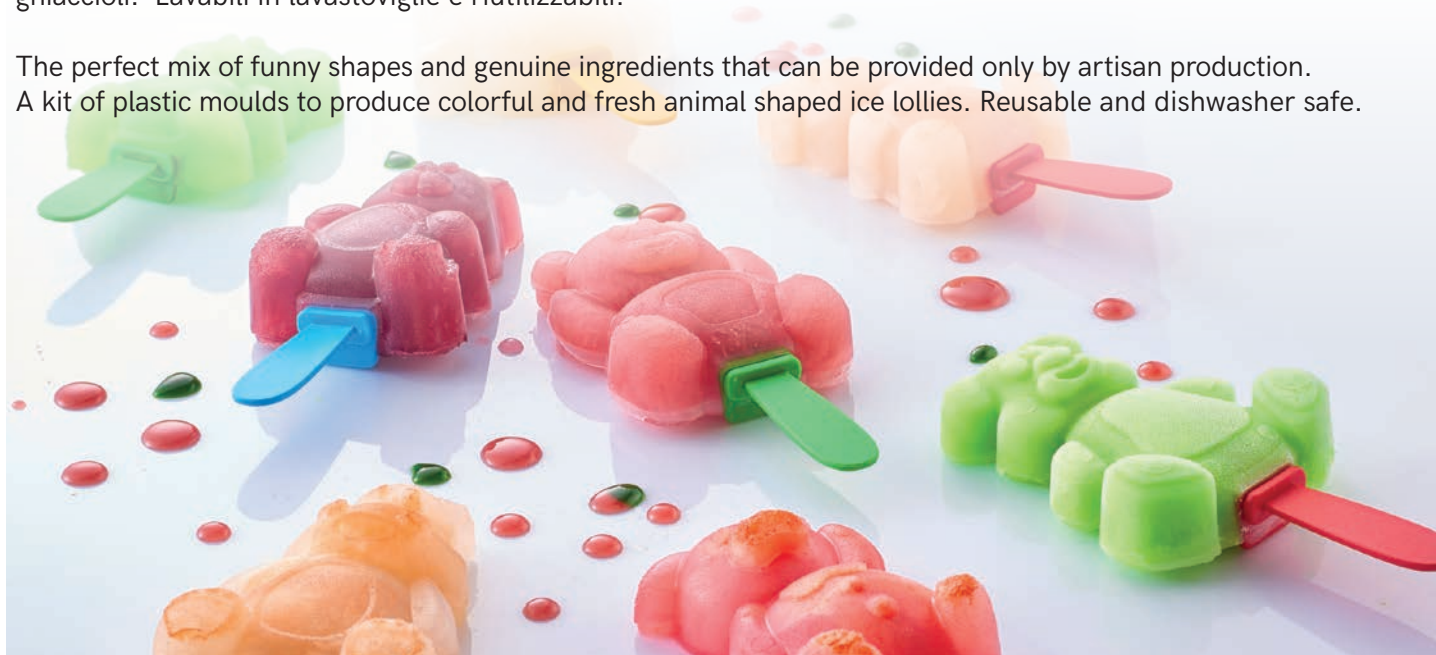

Cow x10 pcs 65x33 h90mm
 Bear x10 pcs 66x28 h87mm
 Cat x10 pcs 61x35 h89mm
 Mouse x10 pcs 60x35 h80mm
 Dog x10 pcs 74x29 h90mm
 Pig x10 pcs 53x37 h87mm
 Hippo x10 pcs 68x31 h95mm
 Chick x10 pcs 85x33 h90mm

SBIKITO1
 80 pcs (8 mod.x10 pcs)
 bastoncini inclusi - stick included

BST100
 Sticks 100 pcs (mix)

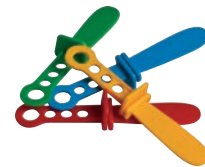

PLEXIGLASS DISPLAYS

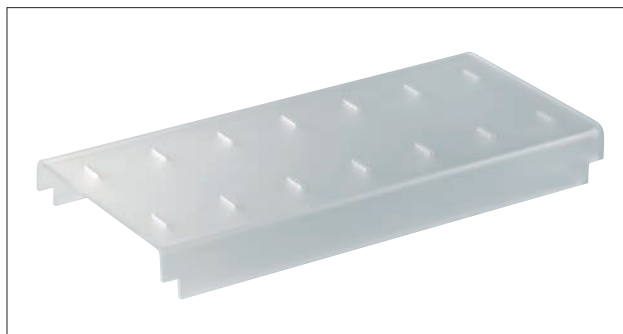

Espositore per vetrina orizzontale
 Display for horizontal showcases

ESPICE14
 Size: 160x360 h35 mm
 Cap. 14 pcs

push UP pops®

L'equilibrato mix di caratteristiche che rendono questo prodotto unico nel suo genere sono: funzionalità, praticità, eleganza e versatilità. Lo stampo, dopo la produzione, diventa un sistema di esposizione in vetrina o negli eleganti banchetti. Ideale per la realizzazione di dolci semifreddi o stuzzicanti aperitivi. Lavabili in lavastoviglie e riutilizzabili.

The balanced mix of features that make this product unique are: functionality, practicality, elegance and versatility. After production, the mould becomes a display system in the showcase or in elegant banquets. Ideal for making semifreddo desserts or tasty appetizers. Reusable and dishwasher safe.



TONDI - ROUNDS
GST01
 100 pcs
 Ø40 h 188mm ~ 90ml



MINI
GST10
 100 pcs
 Ø35 h 196mm ~ 50ml

PUSH UP POPS DISPLAYS



Supporto plastica bianca per abbattitore
 White plastic holder for blast chiller

GSTESPOB
 310x400 h90 mm
 28 sedi - holes

Black & White

IL TUO STILE IN VETRINA
YOUR STYLE IN THE SHOP WINDOW



Vaschette porta gelato conferiscono un tocco di modernità all'interno delle gelaterie. Le nuove vaschette in plastica bianca o nera sono un'originale alternativa all'acciaio e danno risalto ai colori del gelato. Possono essere personalizzate con il vostro logo, sono resistenti agli urti e sono lavabili in lavastoviglie. Personalizzabili con logo.

Ice cream basins to give a touch of modernity inside the ice cream parlors. The new white and black plastic basins are an original alternative to steel and they will emphasize the colors of ice cream. They can be customized with your logo, are shock resistant and dishwasher safe. Customizable with logo.



25 x 36 h 8 cm - **3,6 L**

Bianco - White
AG36258POLB

Nero - Black
AG36258POLN



25 x 36 h 12 cm - **5,8 L**

Bianco - White
AG362512POLB

Nero - Black
AG362512POLN



ACCESSORI PER VASCHEE BASINS ACCESSORIES



Portaconi piccoli
Small ice cream holders
AG09002
Cap. 27 pcs
Misure/Size: 350x140 h52 mm
Fori/Holes: Ø18mm



Portaconi piccoli
Small ice cream holders
AG09003
Cap. 45 pcs
Misure/Size: 350x223 h52 mm
Fori/Holes: Ø18mm

ICE CREAM SPATULAS

Una linea completa di spatole per dare un tocco di colore alle vetrine gelato. Disponibili in vari colori, nelle versioni classica o per carapina, le spatole Martellato sono interamente made in Italy. I materiali sono di alta qualità: cucchiaio in acciaio inox e manico ergonomico in plastica, personalizzabile su richiesta con scritte e loghi.

A complete line of spatulas to give a touch of color to the ice cream display cases. Available in different colors, in classic or carapina versions, Martellato spatulas are entirely made in Italy. The materials are of high quality: stainless steel spoon and ergonomic plastic handle, customizable on request with lettering and logos.



Super confort, con impugnatura ergonomica.
Super comfort, with ergonomic handle.

CLASSIC

Lunghezza totale/ Total length: 26cm
 Manico/ Handle: 13cm

- | | | | | | | |
|---|----------------------------------|--------------------------------------|---------------------------------|-----------------------------------|--------------------------------|--|
| 10SG00
Trasparente
Transparent | 10SG01
Bianco
White | 10SG04
Azzurro
Sky Blue | 10SG05
Verde
Green | 10SG06
Giallo
Yellow | 10SG07
Nero
Black | 10SG100
Finto legno
Wood-like |
|---|----------------------------------|--------------------------------------|---------------------------------|-----------------------------------|--------------------------------|--|

CARAPINA

Lunghezza totale/ Total length: 20cm
 Manico/ Handle: 10cm



- | | | | | | | |
|--|-----------------------------------|----------------------------------|--------------------------------|----------------------------------|---------------------------------|---|
| 10SGC00
Trasparente
Transparent | 10SGC01
Bianco
White | 10SGC02
Lilla
Lilac | 10SGC03
Rosa
Pink | 10SGC05
Verde
Green | 10SGC07
Nero
Black | 10SGC100
Finto legno
Wood-like |
|--|-----------------------------------|----------------------------------|--------------------------------|----------------------------------|---------------------------------|---|

FLUO



Lunghezza totale/ Total length: 27cm
 Manico/ Handle: 14cm



- | | | | | | | |
|--|------------------------------------|----------------------------------|-----------------------------------|-------------------------------|-------------------------------|---|
| SGM00
Trasparente
Transparent | SGM001
Arancio
Orange | SGM003
Bianco
White | SGM004
Giallo
Yellow | SGM007
Rosa
Pink | SGM008
Rosso
Red | SGM100
Finto legno
Wood-like |
|--|------------------------------------|----------------------------------|-----------------------------------|-------------------------------|-------------------------------|---|

PORZIONATORI ICE CREAM SCOOPS



Ideali per realizzare palline di gelato di diverse dimensioni e grammature. I porzionatori a molla Martellato sono realizzati in acciaio inox e presentano un pratico manico rivestito in plastica isolante.

Ideal for making ice cream balls of different sizes and weights. The Martellato spring-loaded portioners are made of stainless steel and feature a practical handle covered in insulating plastic.

- | | | | | |
|--|--|--|--|--|
| 1/65 Lt
Ø 38 mm
10PG01 | 1/40 Lt
Ø 44 mm
10PG02 | 1/30 Lt
Ø 48 mm
10PG03 | 1/24 Lt
Ø 50 mm
10PG04 | 1/20 Lt
Ø 57 mm
10PG05 |
|--|--|--|--|--|

CUCCHIAI SPOONS



I cucchiali in alluminio ultraleggero consentono una perfetta maneggiabilità.

The ultralight aluminum spoons allow perfect handling.

- | | | | |
|------------------------------------|------------------------------------|------------------------------------|------------------------------------|
| Cap. 30 gr
10CG01 | Cap. 42 gr
10CG02 | Cap. 60 gr
10CG03 | Cap. 70 gr
10CG04 |
|------------------------------------|------------------------------------|------------------------------------|------------------------------------|

SEGNAGUSTO - FLAVOUR MARKER

IMMERSIONE - IMMERSION



10SI001B
Segnagusto in plexiglass ad immersione
Immersion plexiglass flavour marker
 150x70 mm bianco opalino/opaline white
 pack 10 pcs

10SI002B
Segnagusto in plexiglass ad immersione
Immersion plexiglass flavour marker
 180x84 mm bianco opalino/opaline white
 pack 10 pcs

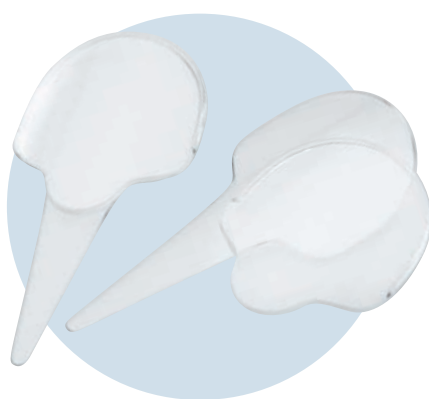

Supporti in plastica per segnagusto
Plastic supports for ice-cream flavour
10SEG
 Cartellini non inclusi/Labels not included
kit 10 pcs - h 19 cm



Inserti neutri
Neutral inserts
10SEG05
 INSERTI NEUTRI PER SEGNAGUSTO 10SEG
 (supporti in plastica non inclusi)
 neutral inserts for plastic support 10SEG
 (plastic supports not included)
kit 30 pcs

APPOGGIO - FREE-STANDING



10SA001B
Segnagusto in plexiglass da appoggio
Free-standing plexiglass flavour marker
 85 x h 50,5 mm bianco opalino/opaline white
 pack 10 pcs

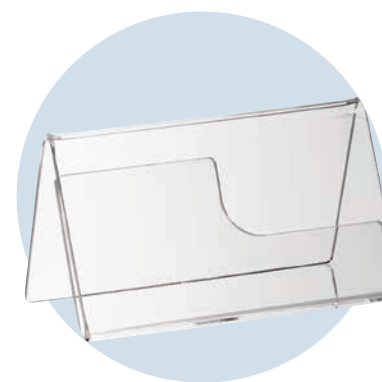

Porta cartellino in plastica
Transparent plastic marker holder
10SEGB
 Misure - Size: 87x52mm
 Cartellini non inclusi/Labels not included
kit 10 pcs



Inserti neutri
Neutral inserts
10SEG06
 INSERTI NEUTRI PER SEGNAGUSTO 10SEGB
 (supporti in plastica non inclusi)
 neutral inserts for plastic support 10SEGB
 (plastic supports not included)
kit 30 pcs



raschietti - scrapers

RTRA1-5
 Set 5 raschietti decorativi misti - Set composed of 5 different decorative scrapers
 Misura - Size 14,5x15cm

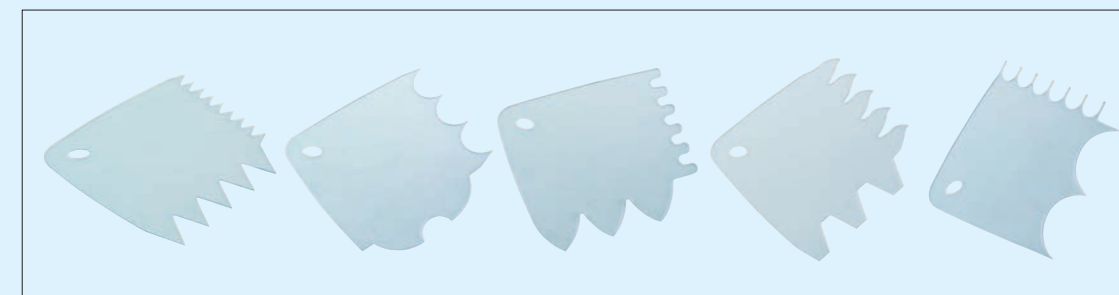

DeepMeltinchoc

MADE IN ITALY

Scioglitore a secco pensato per le gelaterie, grazie alla sua forma e dimensione è ideale per coperture in cioccolato di gelati e semifreddi su stecco. Presentato con colorazione classica, che ricorda i toni del cioccolato per adattarsi ad ogni tipologia di arredo e per essere utilizzato direttamente sul banco. Le caratteristiche tecniche del scioglitore analogici, tra cui il termostato che consente di regolare la temperatura e la vasca estraibile in alluminio anodizzato per una più facile pulizia, fanno di DEEP-MELTINCHOC un articolo essenziale.

Dry melter designed for ice cream parlours, thanks to its shape and size it is ideal for chocolate coatings of ice creams and semifreddi on sticks. Presented with the classical colour that recalls chocolate to be adaptable to any type of environment and to be used straight on the counter. The technical features of the analogical melter, including the thermostat that allows the temperature to be adjusted and the removable anodised aluminium tank for easier cleaning, make DEEP-MELTINCHOC an essential item.



1,7 L

Deep Meltinchoc
MC10
Ø20,5 h21,2 cm



Vaschetta - Basin
MC001001

Vasca estraibile in alluminio anodizzato
Removable basin in anodized aluminum
Ø14 h18 cm

Scocca, coperchio e fondo in resistente materiale plastico
Body, lid and bottom in durable plastic material

PLEXIGLASS ACCESSORIES



Barattoli con coperchio Jars with lid

Misura/size	Cod.
ø 20 h 8 cm	BA2008
ø 20 h 15 cm	BA2015
ø 20 h 20 cm	BA2020
ø 20 h 25 cm	BA2025
ø 20 h 30 cm	BA2030

Misura/size	Cod.
ø 18 h 8 cm	BA1808
ø 18 h 15 cm	BA1815
ø 18 h 20 cm	BA1820
ø 18 h 25 cm	BA1825
ø 18 h 30 cm	BA1830

Misura/size	Cod.
ø 15 h 8 cm	BA1508
ø 15 h 15 cm	BA1515
ø 15 h 20 cm	BA1520

Misura/size	Cod.
ø 12 h 8 cm	BA1208
ø 12 h 15 cm	BA1215
ø 12 h 20 cm	BA1220

Misura/size	Cod.
ø 10 h 8 cm	BA1008
ø 10 h 15 cm	BA1015
ø 10 h 20 cm	BA1020



Contenitore con mezzo coperchio ruotabile Container with rotating half lid

[AG03720](#) - ø 20 x h 20 cm
[AG03730](#) - ø 20 x h 30 cm



Contenitori multiuso Multipurpose container

[AG01410](#) - 25 x18,5 h 20 cm
[AG01420](#) - 30 x18,5 h 30 cm
[AG01430](#) - 35 x18,5 h 40 cm



Reggi con da banco satinato 3 sedi
Glazed counter cones stand 3 holes
AG03000
 25 x 7,5 h 13 cm (Fori/Holes Ø 3,5 cm)



Reggi con da banco 3 sedi
Counter cones stand 3 holes
AG03108
 24,5 x 8,5 h 13,5 cm (Fori/Holes Ø 3,5 cm)



Porta con con con divisorio estraibile
Cones holder with removable partition
AG04610
 43 x 40 h 43 cm



Porta con con con coperchio
Cones holder with lid
AG03650
 30 x 37 h 32 cm



Reggi con da banco 4 sedi
Counter cones stand 4 holes
 14 x 14 h 24 cm (Fori/Holes Ø 3 cm)
AG00208N
base nera/black base
AG00206N
base satinata/glazed base



Reggi con da banco satinato
Glazed counter cones stand
AG03206
3 sedi/holes - 21x 9 h 13 cm (Fori/Holes Ø 3,5 cm)
AG03306
4 sedi/holes - 28,5 x 9 h 13 cm (Fori/Holes Ø 3,5 cm)



Porta con con a tre vani tubolari con coperchi
3-compartment tubular cones holder with lids
AG03640
 36 x 32,5 h 39 cm



Porta con con 12 sedi/Cones holder 12 holes
 33 x 25 h 50 cm (Fori/Holes Ø 3,5 cm)
AG00908
base nera/black base
AG00906
base satinata/glazed base
AG00908P
base nera con porta/black base with door
AG00906P
base satinata con porta/glazed base with door



Porta coni con cassetto estraibile
Cones holder with removable drawer
AG00930
 25,5 x 18 h 60,5 cm



Porta coni girevole 18 sedi
Revolving cones holder 18 holes
 Ø 32 h 60cm cm (Fori/Holes Ø 3,5 cm)
AG00708 - nero/black
AG00706 - satinato/glazed
AG00708P - nero con porta/black with door
AG00706P - satinato con porta/glazed with door



Porta coppette 3 scomparti
Cups holder 3 compartments
AG00501
 30,5 x 11,5cm h 30 cm (int.: Ø 8, Ø 9, Ø 10 cm)



Porta coppette con vano porta palette e tasca per cartellini / Cup holder with spoons compartment and pocket for tags
AG05301
 28 x 25 cm h 55 cm



Contenitore porta palette
Spons container
AG01701
 18,5 x 30 h 19 cm
AG01801
 17 x 26 h 16 cm



Contenitore porta palette
Spons container
AG00606
 22 x 26 h 21 cm
trasparente con fianchi satinati
transparent with glazed sides



Contenitore multiuso
Multipurpose container
AG01720 - 17,5 x 27 h 31 cm
AG01710 - 12,5 x 18 h 20,5 cm

SPECIAL EQUIPMENT



3500 Lady's Kisses in 26 minutes



BALL SHAPING MACHINE

per Baci di Dama e Sfere
for Lady's Kisses and Spheres

EasySphere è lo strumento rivoluzionario che permette di produrre sfere di pasta perfette, abbattendo al massimo i costi di manodopera.

Il sistema innovativo consente di realizzare sfere, con impasti di diverso tipo, riducendo di più del 50% i tempi di produzione rispetto al metodo manuale, con risultati a dir poco eccellenti. Grazie al rullo interno è possibile tagliare l'impasto con estrema facilità e modellare sfere dalla forma perfetta. EasySphere può essere usato da qualsiasi operatore mantenendo lo standard di lavorazione e pezzatura.

Precisione, facilità, velocità: con EasySphere migliorerai il tuo modo di lavorare.

EasySphere is the revolutionary tool that allows you to produce perfectly shaped pastry spheres while cutting labour costs to a minimum.

The innovative system makes it possible to produce spheres with different type of dough, reducing more than 50% on production time compared to the manual method, with results that are nothing short of excellent. Thanks to the internal roller, it is possible to cut the dough very easily and give it a perfect spherical shape. EasySphere can be used by any operator while maintaining the standard of processing and size.

Precision, ease, speed: with EasySphere you will improve the way you work.



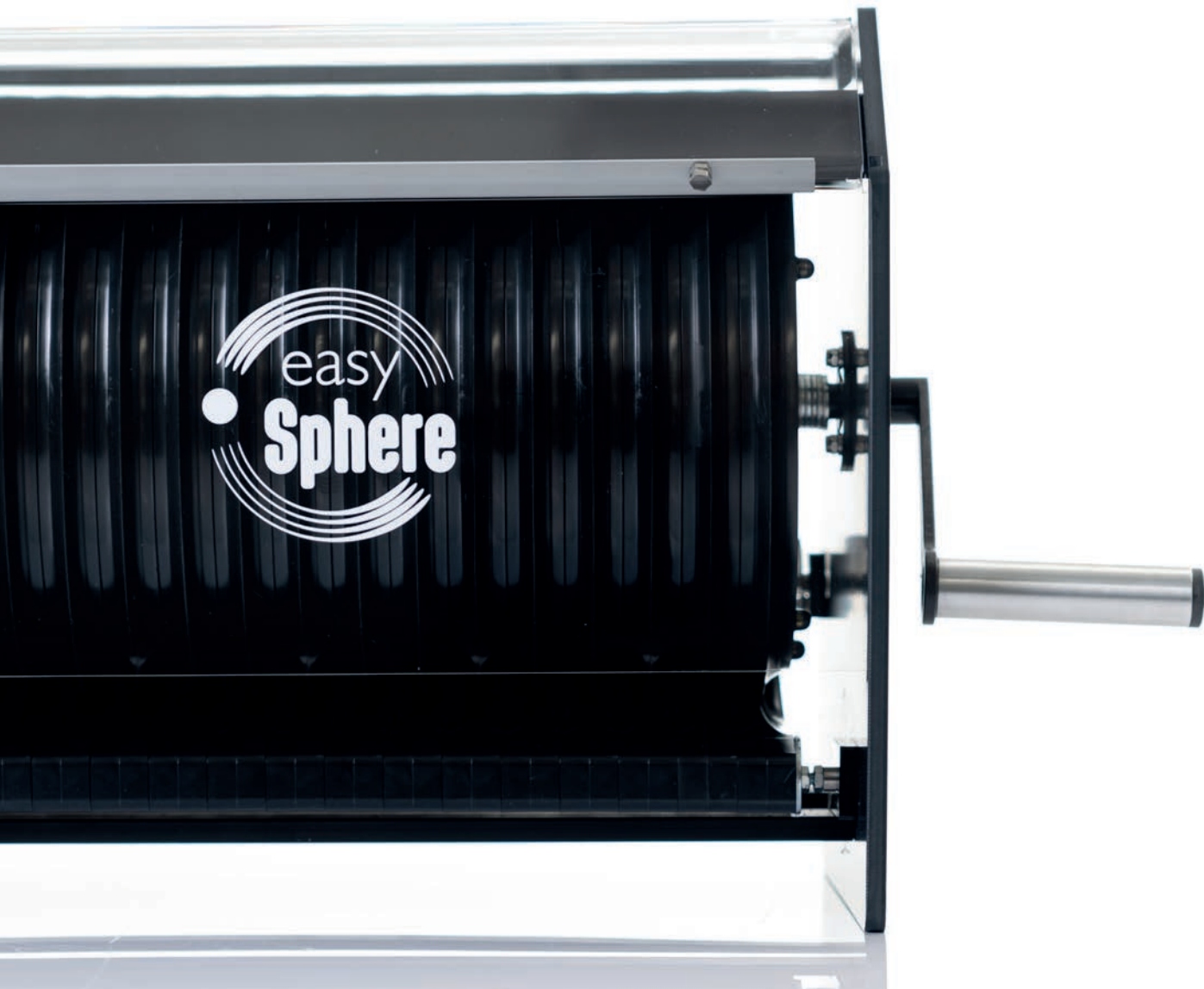

EASYSPIHERE 20

50ES01

Misure ingombro/overall dimensions:
58,5 x 42 x 36,8 cm
per realizzare sfere Ø 20 mm
for making Ø 20 mm balls

EASYSPIHERE 24

50ES02

Misure ingombro/overall dimensions:
58,5 x 42 x 36,8 cm
per realizzare sfere Ø 24 mm
for making Ø 24 mm balls



Accessori inclusi: scovolino per la pulizia del rullo interno, e vassoio estraibile in plexiglass trasparente, per posizionare i filoni di impasto prima della lavorazione in macchina / Accessories included: brush for cleaning the inner roller, and removable transparent plexiglass tray, for positioning the dough loaves before processing in the machine.

Perché scegliere EasySphere?
Con EasySphere avrai:

- **50%** dei TEMPI di produzione
- + **150%** dell' EFFICIENZA produttiva
- **20%** della MANODOPERA

Why choose EasySphere?
EasySphere saves:

- **50%** of production TIMES
- + **150%** of production EFFICIENCY
- **20%** of LABOUR





ACCESSORI PER EASYSHERE EASYSHERE ACCESSORIES

**Tagliapasta estensibile in acciaio con 5
lame lisce/ Extensible steel pasta cutter
with 5 smooth blades**
ROTAPINOX 5 P

Misura ruote/wheel size: Ø 55 mm
Distanza ruote/wheel distance: 10/120 mm



Dime di taglio in plastica trasparente
Transparent plastic grids for cutting

50GD0015

Griglia speciale per tagli da 1,5 cm.
Special grid to cut 1,5 cm.
Ideale per/ideal for EasySphere 20

50GD0018

Griglia speciale per tagli da 1,8 cm.
Special grid to cut 1,8 cm.
Ideale per/ideal for EasySphere 24



PALLINATORE MANUALE MANUAL BALL MACHINE

Per la produzione manuale di
"Baci di Dama", praline e palline
di marzapane.
For the manual production of
"Lady's Kisses", pralines and
marzipan balls.

PALL1

Misure ingombro/overall dimensions:
31 x 39 x 18 cm
per realizzare sfere Ø 16 mm
for making Ø 16 mm balls



artellato



G GIUSEPPE GAGLIARDI
MAESTRO PASTICCERE

LEVEL

BISCUIT & MORE

STRATIFICAZIONE PERFETTA

Level: stendi impasto su ruote maneggevole e pratico che permette di creare rapidamente strati precisi ed uniformi, anche negli spessori più sottili. Facilita e velocizza la stesura uniforme di biscuit, pan di spagna, cioccolato e prodotti simili, scorrendo su diverse superfici, come carta forno o tappeti in silicone. **Level è progettato per razionalizzare la produzione: velocizza i tempi, semplifica i passaggi e riduce i costi.**

PERFECT LAYERING

Level: handy and practical wheel-mounted dough spreader that allows you to quickly create precise and regular layers, even in the thinnest thicknesses. It facilitates and speeds up the uniform spreading of biscuit, sponge cakes, chocolate and similar products, sliding on different surfaces, such as baking paper and silicone mats. **Level is designed to rationalise production: it speeds up times, simplifies steps and reduces costs.**

"Level è uno strumento che ho pensato per tutti coloro che come me cercano precisione e funzionalità, per creare prodotti perfetti."

"Level is a tool that I have designed for all those who, like me, are looking for precision and functionality to create perfect products."

LEVEL

**Stendi impasto in acciaio inox
Stainless steel dough spreader
50LE001**

Misure ingombro/overall dimensions: 48 x 20 h 20 cm



LEVEL

BISCUIT & MORE

CARATTERISTICHE TECNICHE

Completamente in acciaio inox

Scala graduata millimetrica

Manopole di regolazione

Ruote direzionali per scorrimento veloce

Parete mobile per regolazione spessore

Divisori interni per regolare il flusso

Kit accessori per regolazione precisa
degli spessori sottili

Capacità max 12 lt

Peso: 4,3 kg

Misura totale: 48 x 20 h 20 cm

Larghezza apertura: 38 cm

TECHNICAL FEATURES

Made entirely of stainless steel

Millimetric **graduated scale**

Adjustment **knobs**

Directional wheels for fast sliding

Movable wall for thickness adjustment

Internal dividers for flow adjustment

Accessory kit for precise adjustment of thin
shims

Maximum capacity 12 lt

Weight: 4,3 kg

Total size: 48 x 20 h 20 cm

Slot width: 38 cm

MADE IN ITALY



THERMAL

WARMING PLATE

Piastra elettrica riscaldante con piano in vetro temperato idoneo al contatto alimentare, ideale nella lavorazione del cioccolato. E' inoltre perfetta per riscaldare e mantenere caldi i cibi, risultando la soluzione **adatta ai buffet di catering, alberghi e ristoranti**. L'apparecchiatura è composta da una robusta struttura metallo, con fondo riscaldante, il piano in vetro temperato, il termostato per la regolazione della temperatura e piedini antiscivolo per garantire **stabilità e sicurezza** anche durante il funzionamento. Facile da trasportare, grazie al design compatto ed al peso ridotto, e facile da pulire con un panno morbido e umido.

CARATTERISTICHE PRINCIPALI:

Struttura in metallo

Superficie in vetro temperato

Range temperatura: 30°C - 85°C

Spia luminosa di funzionamento

Potenza 260 W

Peso: 2.5 Kg

Electric warming plate with a tempered glass top suitable for food contact, ideal for working with chocolate. Perfect for heating and keeping food warm, it also represents the **solution for catering buffets, hotels and restaurants**.

The equipment has a strong metal structure provided with a heating base, a tempered glass top, a thermostat for temperature regulation and non-slip pads to guarantee **stability and safety**, even during operation. Thanks to the compact design and low weight, it is easy to carry and clean with a soft damp cloth.

MAIN FEATURES:

Metal construction

Tempered Glass surface

Temperature range: 30°C - 85°C

Operating indicator light

Power 260 W

Weight: 2.5 Kg



THERMAL

Piastra riscaldante
Warming Plate
50PR002

Misure ingombro/overall dimensions:
64 x 45,5 x h 7,5 cm



Su richiesta disponibili con cablaggio GB - USA - AUSTRALIA/ On request available with GB - USA - AUSTRALIA wiring

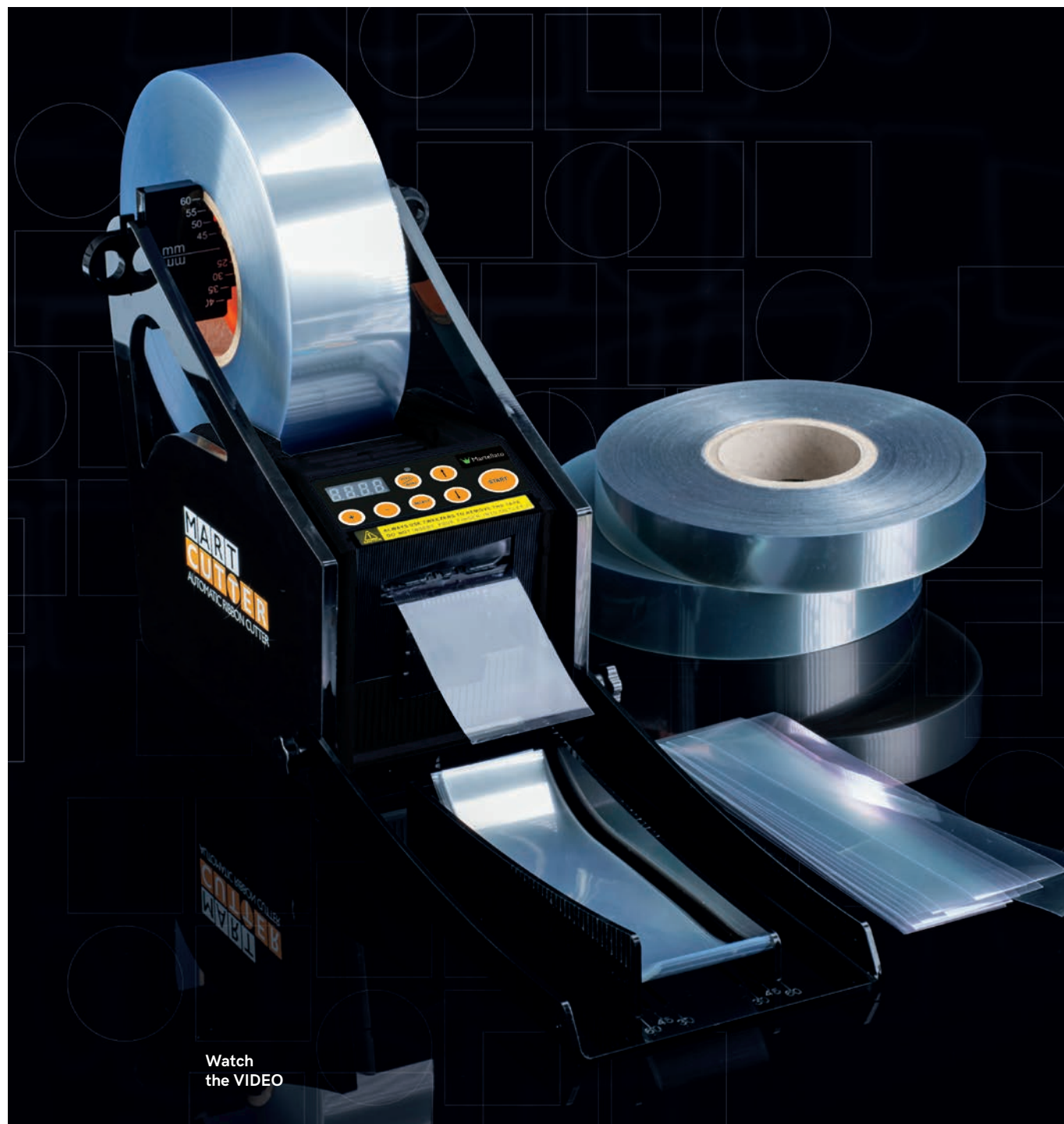

Watch
the VIDEO

MART CUTTER

Taglianastri automatico
Automatic ribbon cutter
50MC001

Ingombro minimo/min. size: 25 x 17,5 h 29 cm
Ingombro max/max size: 48,3 x 17,5 h 29 cm



MART CUTTER

AUTOMATIC RIBBON CUTTER

TAGLIATO PER LA PASTICCERIA CUT OUT FOR PASTRY

Mart Cutter è il taglianastri elettrico ideale per tagliare automaticamente le bobine di acetato della lunghezza desiderata, nella quantità necessaria. Lo strumento consente di ottimizzare e gestire con maggiore semplicità lo stock delle diverse misure, producendo la quantità necessaria di ciascuna lunghezza, evitando errori di taglio e perdite di tempo.

La confezione include taglianastri elettrico, supporto per bobine, vassoio in plex per contenere le strisce di acetato e copertura di cotone per riporre il taglianastri dopo l'uso.

Mart Cutter is the ideal electric ribbon cutter for automatically cutting rolls of acetate to the desired length, in the necessary quantity. The tool makes it easier to optimise and manage the stock of different sizes, producing the necessary quantity of each length, avoiding cutting errors and waste of time.

Package includes electric ribbon cutter, reel stand, plex tray to hold acetate strips and cotton cover to store the ribbon cutter after use.



Grazie al display digitale puoi impostare sia la lunghezza di taglio, scegliendo tra i programmi preimpostati o inserendola manualmente, sia il numero di strisce desiderate.

Thanks to digital display you can set both the cutting length, choosing from preset programs or entering it manually, and the desired number of stripes.

CARATTERISTICHE PRINCIPALI:

Larghezza bobine: fino a 60 mm

Ø bobine: max 210 mm

Spessore acetato: 80/150 my

Misure di taglio: da 5 a 999 mm

Lunghezze preimpostabili: fino a 6

Peso 2,9 kg

Potenza 25 W

Tensione elettrica 100V, 120V, 220-240V
(altri cavi di alimentazione su richiesta)

MAIN FEATURES:

Rolls width: up to 60 mm

rolls Ø: max 210 mm

Acetate thickness: 80/150 my

Cutnig sizes: da 5 a 999 mm

Pre-settable lengths: up to 6

Weight 2,9 kg

Power 25 W

Electric voltage 100V, 120V, 220-240V
(other power cable on request)



Supporto bobine con sedi per accogliere bobine di diverse larghezze mantenendo la centratura di taglio.

Roll support with slots to accommodate different heights while maintaining cutting centring.



Display digitale a LED per visualizzare le impostazioni scelte e l'avanzamento dello stato del lavoro.

Digital LED display to show selected settings and work status progress.

Vassoio per la raccolta delle strisce tagliate. Dopo l'uso può comodamente essere richiuso per ridurre l'ingombro e proteggere la macchina.

Tray for collecting cut strips. It can be easily folded away after use to reduce clutter and protect the machine.

ACETATI - ACETATE

Extra trasparenti, super resistenti, prodotti con materiale di alta qualità. Facili da usare per rivestire stampi e per realizzare e sformare monoporzioni e mignon. Antiaderenti per uso alimentare. Adatti al raffreddamento in abbattitore, congelatore e frigo, ma non adatti alla cottura.

Extra-clear, super-strong, made of high-quality material. Easy to use for coating moulds and for making and unmoulding monoportions and mignons. Non-stick for food use.

Suitable for cooling in blast chillers, freezers and fridges, but not suitable for baking.

NASTRI - RIBBONS



h (mm)	Codice - Code	h (mm)	Codice - Code
h 25	NSA H 25	h 45	NSA H 45
h 30	NSA H 30	h 50	NSA H 50
h 35	NSA H 35	h 55	NSA H 55
h 40	NSA H 40	h 60	NSA H 60

Specifiche / features

spessore / thickness
80 my

lunghezza
length 305 mt



anima / core
Ø 70 mm

misura esterna
external size
Ø 210 mm

Il materiale multistrato con il quale sono realizzati i nostri nastri proviene parzialmente da plastica riciclata. La loro speciale composizione li rendono idonei al contatto alimentare e rispettosi dell'ambiente.

The multi-layer material with which our ribbons are made comes partly from recycled plastic. Their special composition makes them suitable for food contact and environment-friendly.



Tutti i rotoli sono adatti alla taglianastri
All ribbons are suitable for ribbon cutter

50MC001



GUITAR

CUTTER MARTELLATO

Versatile, funzionale e resistente: le caratteristiche della nuova chitarra in alluminio la rendono il tuo partner nella produzione quotidiana.

Uno strumento che ti permetterà di lavorare in modo preciso semplificando i passaggi ed **aumentando la produttività**. Sarà veloce e facile tagliare cremi, ganache, pasta frolla e sfoglia, tutte le masse morbide, le materie prime ed i prodotti finiti. La struttura è progettata per conferire maggior stabilità e forza nel taglio, ridurre lo sforzo, ottimizzare la produzione, riducendo sprechi, elevando gli standard e l'efficienza.

Versatile, functional and durable: thanks to its features, the new aluminum guitar is your essential partner in daily production.

A tool that will allow you to work precisely, simplifying steps and **increasing productivity**. It will be quick and easy to cut creams, ganaches, shortcrust and puff pastry, all soft masses, raw materials and finished products.

The structure is designed to give greater stability and strength in the cutting process, reducing effort and waste, optimizing production, raising standards and efficiency.

MADE IN ITALY



CARATTERISTICHE TECNICHE:

Misura telaio/frames size: 62,2 x 44,2 cm

Misura base/base size: 60 x 40 h 10 cm

Piano di taglio/cutting surface: 38 x 40 mm

Misura totale/total size: 63,6 x 44,2 h 10,9 cm

Peso base/ base weight 5,5 kg

Peso telaio/ frame weight 5,5 kg

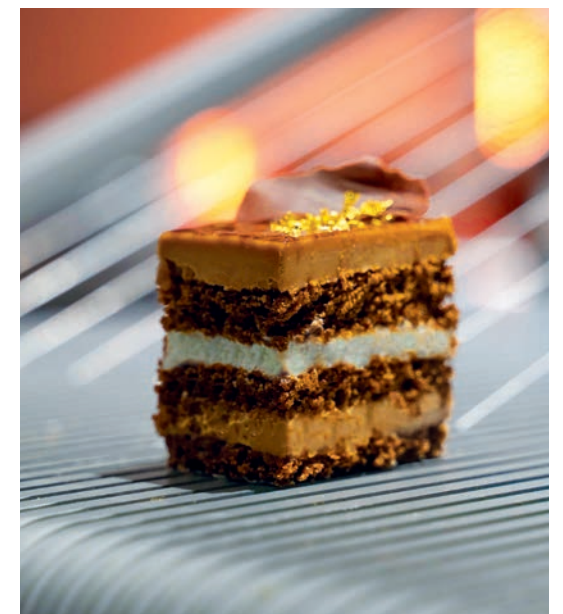
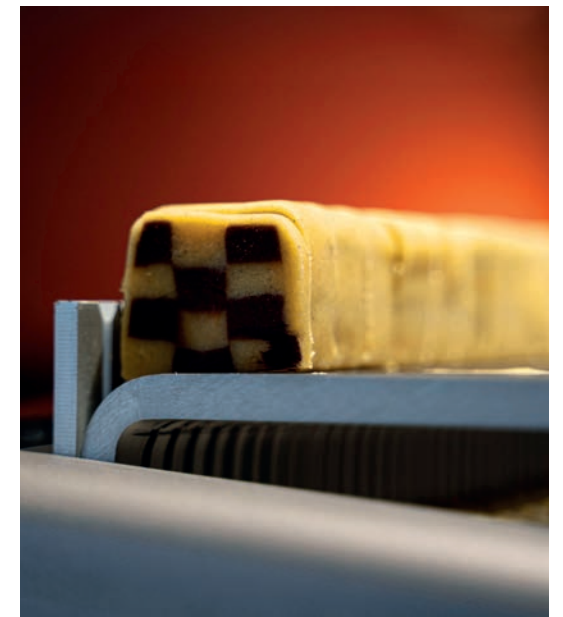
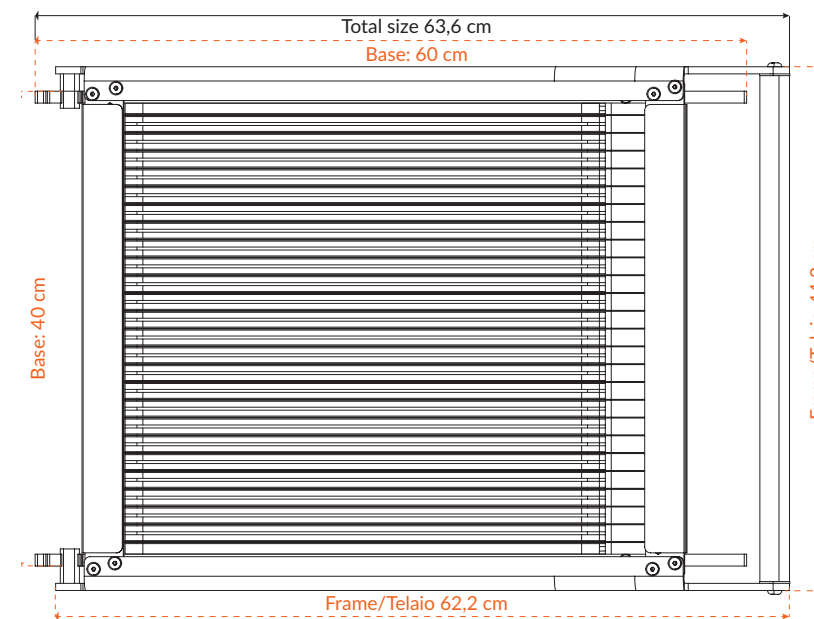

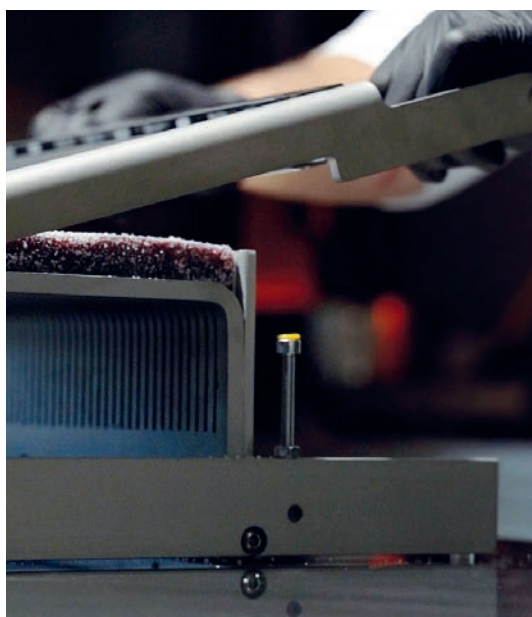

BASE

La base, realizzata completamente in alluminio, ha l'**angolo di taglio più ampio per dare maggiore forza meccanica** e ridurre lo sforzo del professionista. E' inoltre più ampia ed allungata per una **maggiore stabilità durante il taglio**. La sua struttura garantisce maggiore maneggevolezza e facilità di pulizia.

The base, made entirely of aluminum, has a **wider cutting angle to give greater mechanical strength** and reduce the professional's effort. It is also wider and longer to give **more stability during cutting**. Its structure ensures greater handling and ease of cleaning.

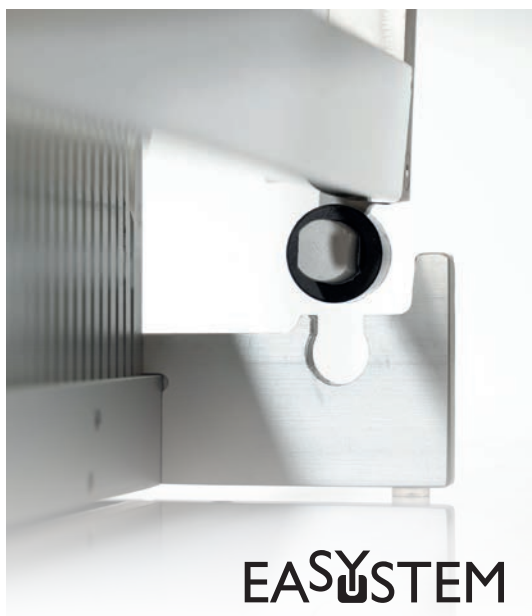

EASYSYSTEM

TELAIO /FRAME

Telai in acciaio, con manico ergonomico, facilmente intercambiabili grazie a **Easy System**, l'esclusivo sistema di incastro che ne facilita l'inserimento. Sono **disponibili in diverse misure di taglio per consentire varie combinazioni** e creare mignon, monoporzioni, cremini, praline e altro.

Sono inclusi vassoio in acciaio e la raplette in plastica per facilitare lo spostamento dei prodotti.

Steel frames, with ergonomic handle, are easily interchangeable thanks to the **Easy System**, the exclusive interlocking system that facilitates insertion. They are **available in different cut sizes to allow various combinations** and create mignons, single portions, cremini, pralines and more. The steel tray and the plastic raplette are included to facilitate the movement of the products.

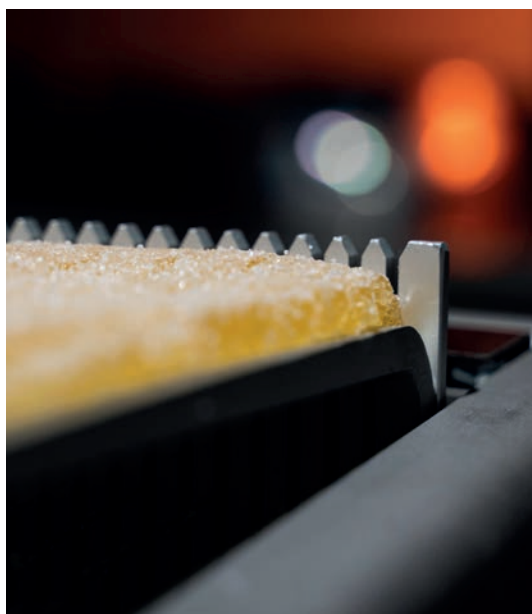

Every Day
with you

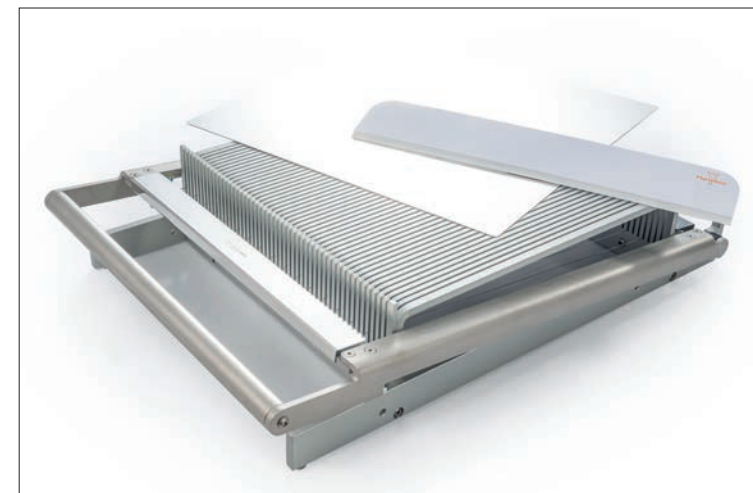

GUITAR CUTTER

FULL SET
50CS200

- 1 Base 60 x 40 h 10 cm
- 3 telai/frames, misure di taglio/cutting distances: 22,5 - 30 - 45 mm
- 1 Raplette
- 1 Piatto acciaio inox/Stainless steel plate
- 1 Kit assistenza/Service kit
- Misura totale/Total size: 636 x 441 h 109 mm



GUITAR CUTTER

BASE
50CSBA

Piano di taglio/Cutting surface: 38 x 40 cm
Misura totale/Total size: 60 x 40 h 10 cm



GUITAR CUTTER TELAI/FRAMES

- 50CSTE15**
Misura taglio/Cutting size: 15 mm
- 50CSTE22**
Misura taglio/Cutting size: 22,5 mm
- 50CSTE30**
Misura taglio/Cutting size: 30 mm
- 50CSTE37**
Misura taglio/Cutting size: 37,5 mm
- 50CSTE45**
Misura taglio/Cutting size: 45 mm

CHITARRE - GUITARS

EASY SYSTEM

Il sistema ad incastro facilita l'inserimento ed il cambio dei telai, riducendo i tempi di montaggio, smontaggio e manutenzione.
The interlocking system makes it easier to insert and change frames, reducing assembly, disassembly and maintenance time.

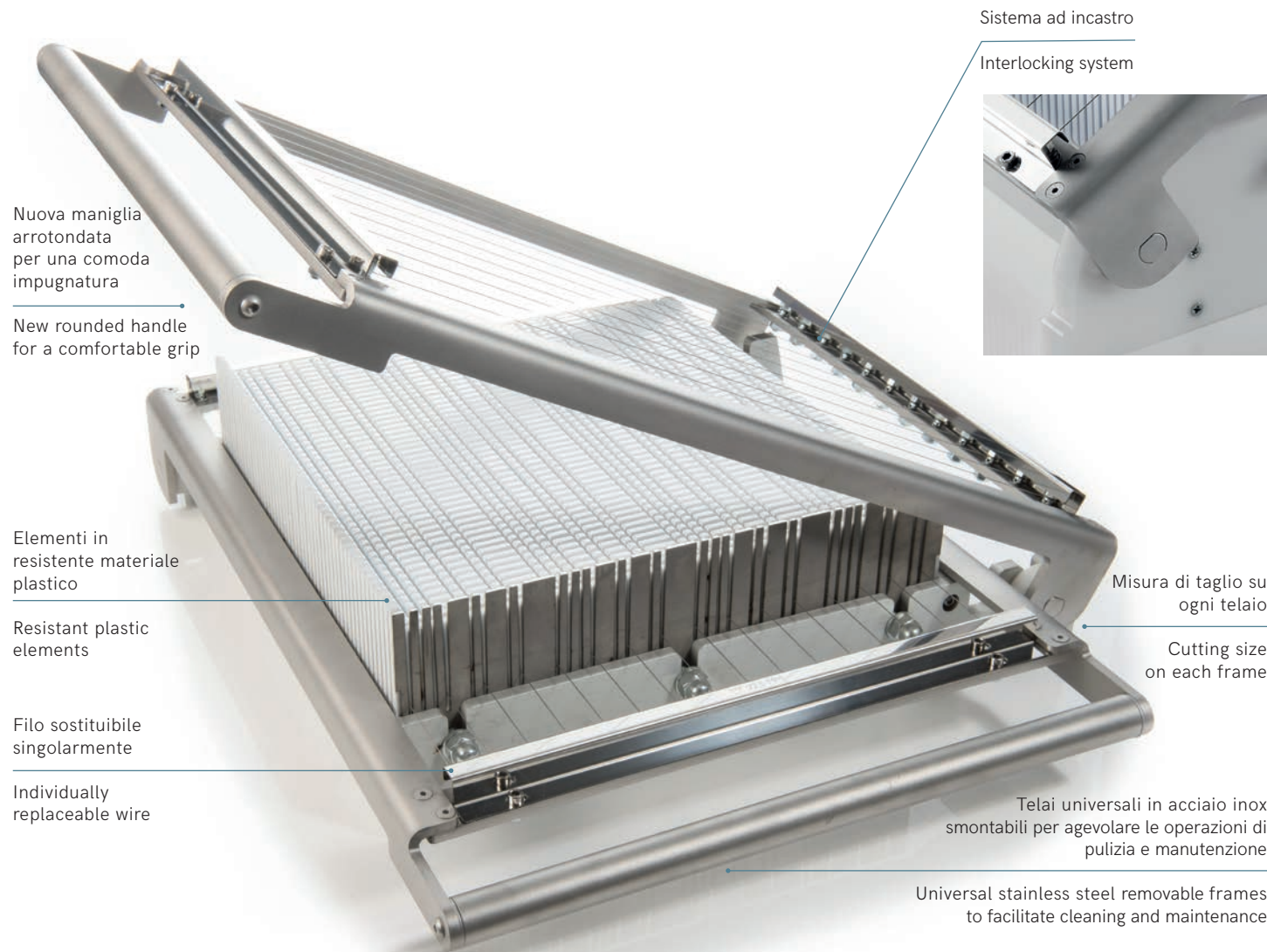

Nuova maniglia arrotondata per una comoda impugnatura
New rounded handle for a comfortable grip

Elementi in resistente materiale plastico
Resistant plastic elements

Filo sostituibile singolarmente
Individually replaceable wire

Sistema ad incastro
Interlocking system



Misura di taglio su ogni telaio
Cutting size on each frame

Telai universali in acciaio inox smontabili per agevolare le operazioni di pulizia e manutenzione

Universal stainless steel removable frames to facilitate cleaning and maintenance

La chitarra è lo strumento ideale per tagliare in modo preciso **cremini, ganache, gelatine, mignon e masse morbide**. La base di taglio è realizzata in resistente materiale plastico, i telai sono in acciaio inox e i fili intercambiabili singolarmente.

La chitarra è composta da una solida base e da telai di diverse misure, fornibili separatamente in base alle esigenze del singolo operatore, oltre ad essere predisposta per il taglio e il calibro di grandi quantità di prodotti in modo preciso e privo di imperfezioni. Nella confezione delle basi sono presenti: 1 piatto in acciaio inox - 1 racla PST - 3 fili di ricambio - 2 chiavi per il fissaggio fili.

The guitar is the ideal tool for cutting **cremini, ganache, jellies, mignons and soft masses** precisely. The cutting base is made of strong plastic material, the frames are made of stainless steel and the wires are individually interchangeable.

The guitar consists of a solid base and frames of different sizes, which can be supplied separately according to the needs of the individual operator, as well as being predisposed for cutting and calibrating large quantities of products precisely and without imperfections. In the packaging of the bases there are: 1 stainless steel plate - 1 plastic spatula - 3 spare wires - 2 keys for fixing wires.

DOUBLE

La chitarra doppia permette di tagliare rapidamente il prodotto in un unico passaggio. Ideale per produrre perfetti quadrati e rettangoli di diverse dimensioni.

The double guitar allows you to quickly cut the product in a single operation. Ideal for producing perfect squares and rectangles of different sizes.

50-CD100N
BASE CON PIANO DI TAGLIO
BASE WITH CUTTING SURFACE

36X35CM
TELAJ NON INCLUSI.
FRAMES NOT INCLUDED.



Telaio base in alluminio
Aluminum base frame

SINGLE

50-CS100
BASE CON PIANO DI TAGLIO
BASE WITH CUTTING SURFACE

36X42CM
TELAJ NON INCLUSI.
FRAMES NOT INCLUDED.



Base in polietilene
Polyethylene base

TELAJ - FRAMES

Misura-Size: 615x427 mm

Maniglia arrotondata per una comoda impugnatura
Rounded handle for a comfortable grip

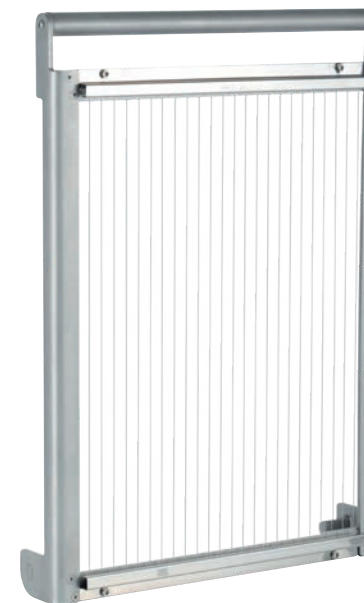

TELAIO PER TAGLIO FRONTALE
FRAME FOR FRONTAL CUTTING

15 mm
50-C015

TELAJ PER TAGLIO FRONTALE E LATERALE
FRAMES FOR FRONTAL AND SIDE CUTTING

22 MM	30 MM	45 MM
50-C022	50-C030	50-C045

Parti ricambio - Spare parts

Piatto Inox
Steel Sheet
CHITRIC 6/D

Spatola Plastica
Plastic spatula
50SPB43
430 h80 mm

Chiavi fissaggio
Special Spanner
CHITRIC 8
2 pcs

Filo Inox
Inox wire
CHITRIC 9
1 pc

Viti e Dadi
Bolts and Nuts
CHITRIC 10
2+2 pcs

MINI CHITARRE - MINI GUITARS

EASY SYSTEM

Il sistema ad incastro facilita l'inserimento ed il cambio dei telai, riducendo i tempi di montaggio, smontaggio e manutenzione.
The interlocking system makes it easier to insert and change frames, reducing assembly, disassembly and maintenance time.

Filo sostituibile singolarmente
Individually replaceable wire

Elementi in resistente materiale plastico
Resistant plastic elements

Base in polietilene leggera e maneggevole
Base in light and handy polyethylene

Base in polietilene leggera e maneggevole
Base in light and handy polyethylene

Base in polietilene leggera e maneggevole
Base in light and handy polyethylene

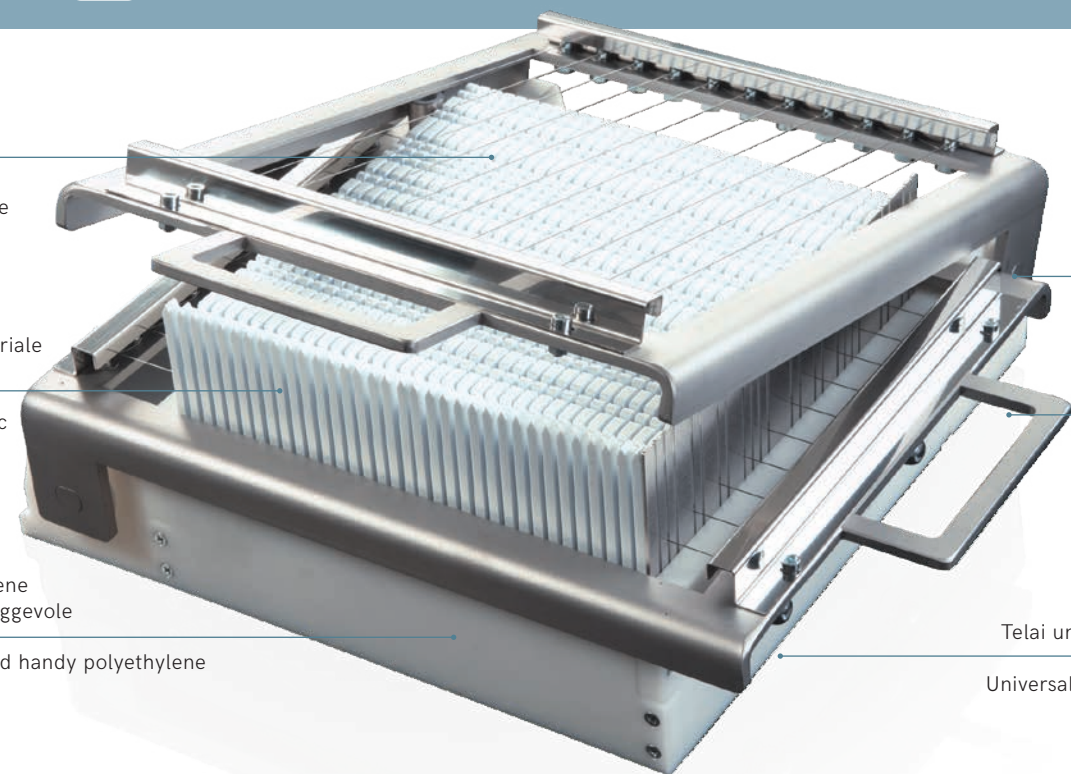

Sistema ad incastro

Interlocking system

Misura di taglio su ogni telaio
Cutting size on each frame

Misura di taglio su ogni telaio
Cutting size on each frame

Telai universali in acciaio inox

Universal stainless steel frames

La **MiniChitarra**, ideale per ristoranti, gelaterie e cioccolaterie, è adatta a piccole produzioni di prodotti dolciari. Grazie alle dimensioni contenute può essere facilmente riposta anche in piccoli spazi e utilizzata all'occorrenza. Inclusi nella confezione: 1 piatto inox - 1 racla PST - 3 fili di ricambio - 2 chiavi per il fissaggio fili.

The **Mini Guitar**, ideal for restaurants, ice-cream and chocolate shops, is suitable for small productions of confectionery products. Thanks to its small size it can be easily stored even in small spaces and used when necessary. Included in the package: 1 stainless steel plate - 1 plastic spatula - 3 spare wires - 2 keys for wire fixing.

SINGLE

BASE CON PIANO DI TAGLIO
BASE WITH CUTTING SURFACE

25X28CM

1 TELAIO INCLUSO.
1 FRAME INCLUDED.

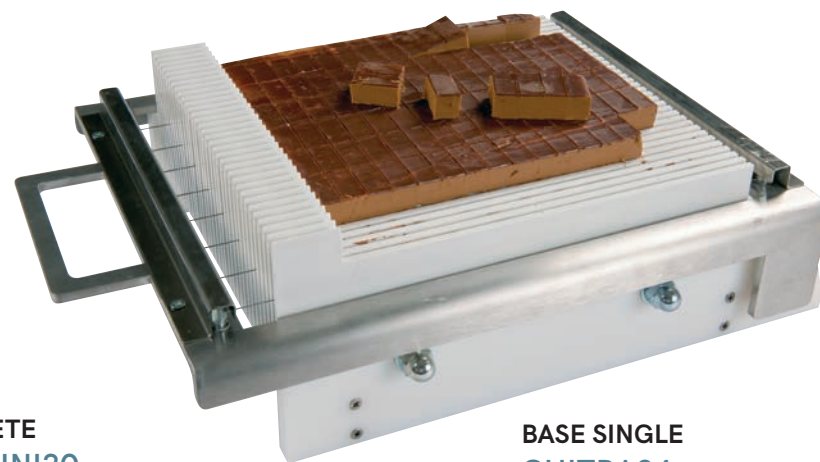

COMPLETE CHITMINI15
con 1 telaio 15 mm
with 1 frame 15 mm

COMPLETE CHITMINI
con 1 telaio 22 mm
with 1 frame 22 mm

COMPLETE CHITMINI30
con 1 telaio 30 mm
with 1 frame 30 mm

BASE SINGLE CHITBA24
Base - senza telai
Base - without frames

DOUBLE



La chitarra doppia permette di tagliare rapidamente il prodotto in un unico passaggio. Ideale per produrre perfetti quadrati e rettangoli di dimensioni differenti. Telai smontabili per agevolare le operazioni di pulizia e manutenzione.

The double guitar allows you to quickly cut the product in one step. Ideal for producing perfect squares and rectangles of different sizes. Removable frames to facilitate cleaning and maintenance.

BASE CON PIANO DI TAGLIO
BASE WITH CUTTING SURFACE

24X25CM

2 TELAII INCLUSI
2 FRAMES INCLUDED

COMPLETE CHITMINID22
con 2 telai da 22 mm
with 2 frames 22 mm

COMPLETE CHITMINID30
con 2 telai da 30 mm
with 2 frames 30 mm

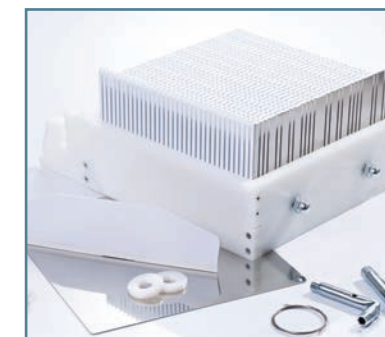

BASE DOUBLE CHITBAD24
Base - senza telai
Base - without frames

TELAII - FRAMES

Misura-Size: 443x314 mm



TELAIO PER TAGLIO FRONTALE
FRAME FOR FRONTAL CUTTING

15 mm
CHIT15

TELAIO PER TAGLIO FRONTALE E LATERALE
FRAME FOR FRONTAL AND SIDE CUTTING

22,5 mm
CHIT22
intercambiabile
interchangeable

30 mm
CHIT30
intercambiabile
interchangeable

Parti ricambio - Spare parts

Piatto Inox
St. steel Sheet
CHITP

Spatola Plastica
Plastic spatula
50SPB30
300 h80 mm

Chiavi Fissaggio
Special Spanner
CHITRIC 8
2 pcs

Filo Inox
Inox wire
CHITRIC 9
1 pc

Viti e Dadi
Bolts and Nuts
CHITRIC 10
2+2 pcs

CHITARRE A SPINTA DRIVING-FORCE GUITARS

Ideale per tagliare **cremini e ganache con frutta secca o prodotti duri e piccola pasticceria anche a bassa temperatura**. L'avanzamento del piano di lavoro avviene manualmente, attraverso un volantino azionato dall'operatore, che può controllarne la velocità. Il filo corto garantisce una maggiore resistenza meccanica e consente quindi di tagliare in porzioni precise anche gli impasti più duri o congelati. Facile da pulire, questo strumento non richiede alcuna manutenzione.

Ideal for cutting **cremini and ganache with dried fruit or hard products and small pastries even at low temperature**. The advancement of the work table is done manually, through a handwheel operated by the user, who can control its speed. The short wire guarantees greater mechanical resistance and therefore allows even the hardest or frozen dough to be cut into precise portions. Easy to clean, this tool does not require any maintenance.

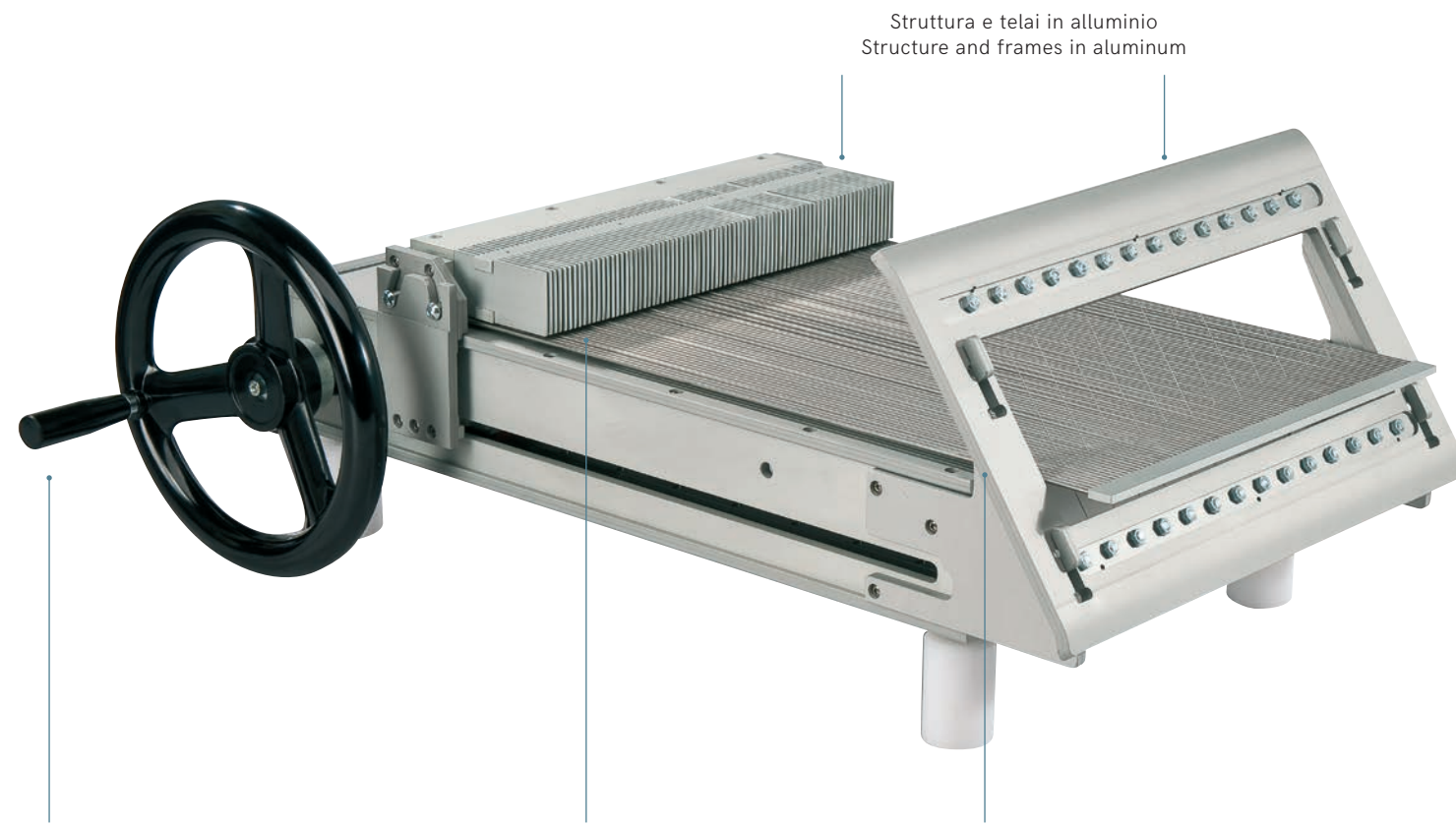

Struttura e telai in alluminio
Structure and frames in aluminum

Manopola di avanzamento grande per permettere un taglio più preciso e delicato

Large hand wheel to allow a more precise and delicate cut

Base di avanzamento asportabile per una migliore pulizia

Removable base for better cleaning

Inserimento dei telai ad incastro
Frame insertion by interlocking

Parti ricambio - Spare parts

Piatto Inox
Steel Sheet

CSM0602

Ideal for:
CSM060 BIG

Spatola
Spatula

CSMSPB60

Ideal for:
CSM060 BIG

Piatto Inox
Steel Sheet

CSM0402

Ideal for:
CSM040 SMALL

Spatola
Spatula

CSMSPB40

Ideal for:
CSM040 SMALL

Chiavi di fissaggio
Spanners

CHITRIC 8

Filo Inox
Inox wire

CHITRIC 9

Inclusi nella confezione delle basi: 1 piatto inox - 1 racla PST - 2 chiavi per il fissaggio fili.
Included in the package: 1 stainless steel plate - 1 plastic spatula - 2 keys for wire fixing.



CSM060

PIANO DI TAGLIO
CUTTING SURFACE

60X60CM

TELAJ NON INCLUSI.
FRAMES NOT INCLUDED.

Misura chitarra chiusa
Closed guitar size:
73x103 h30 cm
Misura apertura massima
Maximum open size:
73x167 cm

CSM040

PIANO DI TAGLIO
CUTTING SURFACE

40X40CM

TELAJ NON INCLUSI.
FRAMES NOT INCLUDED.

Misura chitarra chiusa
Closed guitar size:
53x83 h30 cm
Misura apertura massima
Maximum open size:
53x126 cm

60X60CM

TELAJ - FRAMES

10 MM - CSM06001

15 MM - CSM06002

20 MM - CSM06003

25 MM - CSM06004

30 MM - CSM06005

35 MM - CSM06006

40 MM - CSM06007

50 MM - CSM06008

60 MM - CSM06009

40X40CM

TELAJ - FRAMES

10 MM - CSM04001

15 MM - CSM04002

20 MM - CSM04003

25 MM - CSM04004

30 MM - CSM04005

35 MM - CSM04006

40 MM - CSM04007

50 MM - CSM04008

60 MM - CSM04009

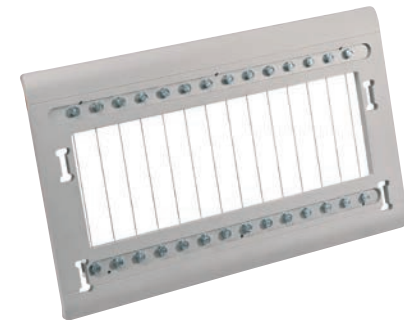

PERFECT LAYERS

Stratificazione perfetta! Telai precisi e facili da usare per creare cremi, ganache e gelatine di frutta multi-strato con pesi ed altezze sempre costanti.
Perfect layering! Precise and easy to use frames to create cremi, ganaches and multi-layer fruit jellies with constant weights and heights.

50TLSPECIAL
MISURA INTERNA
INTERNAL SIZE

36X36 CM

2+2 QUADRI INCLUSI.*
2+2 FRAMES INCLUDED.*

* h 3 mm **50TLS03** * h 5 mm **50TLS05**

* Plastic spatula
50SPB43
430 h80 mm

fogli acetato
NSA39X39MO
390x390 mm
pack 100 pcs



50TLMINI
MISURA INTERNA
INTERNAL SIZE

24X24 CM

2+2 QUADRI INCLUSI.*
2+2 FRAMES INCLUDED.*

* h 3 mm **50TLM03** * h 5 mm **50TLM05**

* Plastic spatula
50SPB30
300 h80 mm

fogli acetato
NSA27X27MO
270x270 mm
pack 100 pcs

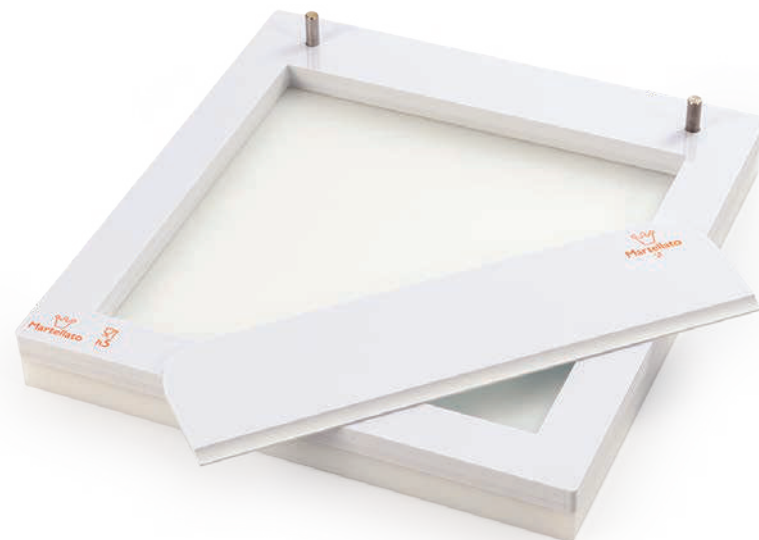

SINGLE LAYERS

Telai in acciaio inox per creare precise stratificazioni in cioccolato, biscuit e altri impasti in modo semplice e veloce.
Stainless steels frames to produce perfect layers in chocolate, biscuit and other doughs in easy and fast way.

FIXED FRAMES
MISURA INTERNA
INTERNAL SIZE
36X36CM

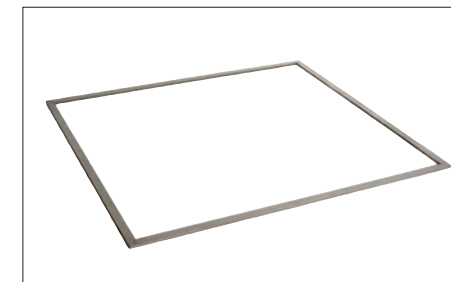

50QG03
h 3 mm
Misura esterna/External Size: 38x38 cm

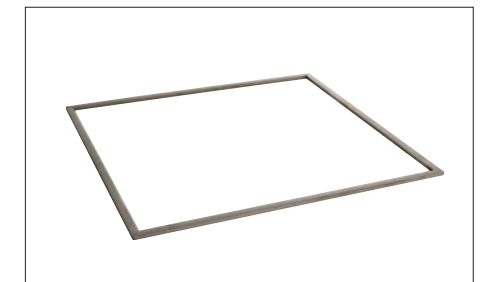

50QG05
h 5 mm
Misura esterna/External Size: 38x38 cm

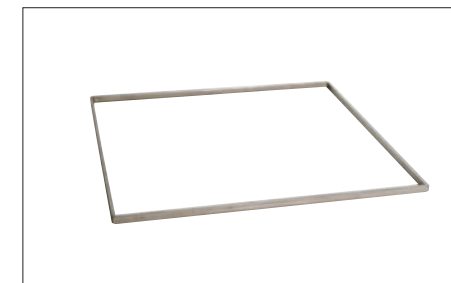

50QG10
h 10 mm
Misura esterna/External Size: 37x37 cm

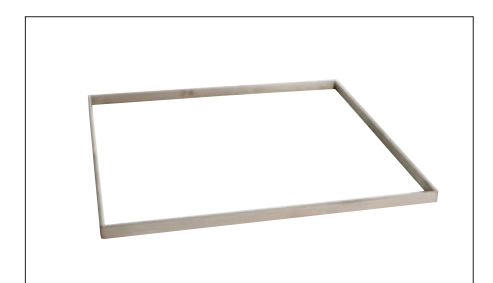

50QG15
h 15 mm
Misura esterna/External Size: 37x37 cm

PLASTIC FRAMES
MISURA INTERNA
INTERNAL SIZE
37X57CM
Misura esterna
External Size: 47x67 cm

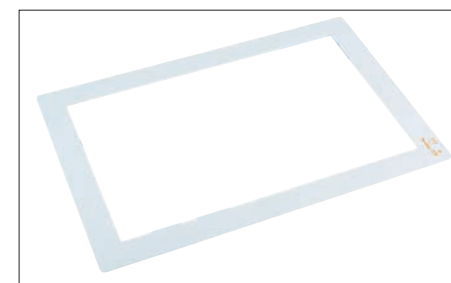

TL 03
h 3 mm

TL 04
h 4 mm

TL 05
h 5 mm

CHARLOTTE FRAME
MISURA INTERNA
INTERNAL SIZE
38X58CM
Misura esterna
External Size: 39x59 cm

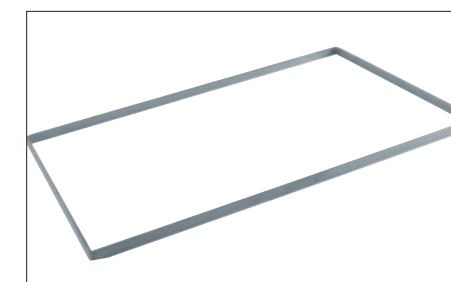

TL 15
h 15 mm

SPINNER

E-Turning Cake

L'indispensabile giratorta elettrico per il tuo laboratorio
Electric Cake Turntable: an essential tool for your laboratory



Il giratorta elettrico: compatto, pratico e leggero, che semplifica e aiuta il tuo lavoro.

The electric turning cake: compact, practical and light, that simplifies and helps your work.

SPINNER
 Misure / Size: 27 x 26 h 12 cm
 Peso / Weight: 1,6 Kg

MADE IN ITALY



Regolatore di velocità

Speed regulator

Piatto con scala graduata da 60 a 220 mm

Graduated plate between 2,36 and 8,66 inch

Anello trascinatore circolare

Roller ring support

Luminosità LED proporzionale alla velocità

LED brightness proportional to speed

Piatto in plexiglass e tappeto in silicone

Plexiglass plate and silicone mat

Rotazione oraria ed antioraria

Clockwise and anti-clockwise rotation

Composto da un **corpo stabile** con trascinatore circolare sul quale ruota un **piano perfettamente planare** in plexiglass, con **scala graduata** in cm ed inch, consente il corretto e costante posizionamento del prodotto e la misurazione del decoro.

The cake turntable is composed by a **stable base** with circular guide and **planar Plexiglas plate**, with **graduated scale** for the correct and constant positioning of the product and the measurement of the decoration.

Con il regolatore puoi **variare la velocità** e il **senso di rotazione**. I **led direzionali** indicano il senso di rotazione ed in base all'intensità la velocità. Il pratico tappetino in silicone antiscivolo garantirà maggiore stabilità durante la lavorazione.

The regulator allow to **vary speed** and **direction of rotation**. **LEDs indicate direction** and speed of rotation. The practical non-slip silicone mat will ensure greater stability during processing.



GIRATORTA - CAKE TURNTABLE



PROFESSIONAL
Giratorta in lega di alluminio
anodizzato/Anodised aluminium
alloy cake turntable

GIRA6 - Ø 30 H 13 CM
Resistente alle abrasioni, agli acidi e facile
da pulire/Resistant to abrasion, acids and
easy to clean



Giratorta in plastica/Plastic cake
turntable

GIRA - Ø 32 H 10 CM



INCLINABILE-TILTING
Giratorta in plastica/Plastic cake
turntable

40-W125 - Ø 23 H14 CM
Inclinabile fino a 20°, con tappeto
antiscivolo per mantenere stabile il dolce/
Tilting up to 20°, with non-slip mat to
keep cake stable



BASIC
Giratorta in lega di alluminio
Aluminium alloy cake turntable

GIRA5 - Ø 29 H 13 CM
Resistente e planare/Resistant and flat



Giratorta in plastica/Plastic cake
turntable

GIRA7 - Ø 30,4 H 3,2 CM



**PALA PER DOLCI - CAKE
LIFTER**
Acciaio inox/stainless steel

TS1 - Ø 28 CM
Rende facile lo spostamento di
torte, crostate, pane e articoli
da forno/For easy handling and
moving of a whole cakes, tarts,
pastry, bread and bakery items.



STENDI PASTA - ROLLING MACHINE

La stendi pasta permette una grande economia di tempo e soprattutto non necessita di personale specializzato per operare. È stata ideata e realizzata per risolvere i problemi di formatura dei dischi per la preparazione di pizze, pane, focacce, tortine, ecc. La macchina lavora a freddo e non altera le caratteristiche della pasta. La stendi pasta è di semplice utilizzo e offre una qualità costruttiva di altissimo livello. Selezionare gli spessori per l'impasto finale è un'operazione rapida ed intuitiva.

The rolling machine allows a great economy of time and above all it does not require specialised personnel to operate. It is designed and manufactured to solve the problems of forming discs for the preparation of pizzas, bread, focaccia, cakes, etc.. The machine works cold and does not alter the characteristics of the dough. The rolling machine is easy to use and offers the highest level of construction quality. Selecting the thicknesses for the final dough is a quick and intuitive operation.



31 CM
LUNGHEZZA RULLO
ROLLER LENGTH

40-W200
Ingombro totale - Total overall size:
45x35,5 - h37,5cm

50 CM
LUNGHEZZA RULLO
ROLLER LENGTH

40-W20045
Ingombro totale - Total overall size:
65x35,5 - h37,5cm

Scocca di protezione: protezione dei rulli in plexiglass trasparente per la massima sicurezza, senza alterare la visibilità.

Protective Shell: transparent plexiglass roller protection for maximum safety, without altering visibility.

Monorullo in teflon
Teflon single roller

Manopola per la regolazione del spessore
Thickness adjuster knob

1 • 2 • 3 • 4 mm

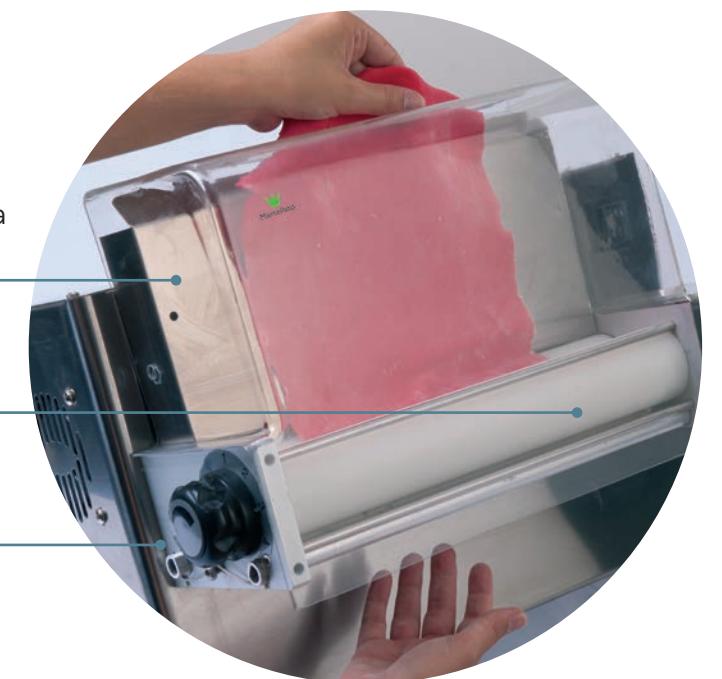

Potenza motore monofase: KW 0,25 - Alimentazione: 230 1ph 50Hz
Single-phase motor power: KW 0,25 - Power supply: 230 1ph 50Hz

IL SISTEMA PIÙ COMPLETO PER CONSERVARE I TUOI PRODOTTI
 THE MOST COMPLETE SYSTEM TO PROTECT YOUR PRODUCTS

MADE IN ITALY

LEGGEREZZA

Realizzati in materiale plastico di alta qualità, sono ultra leggeri e facili da trasportare

LIGHTNESS

Made of high quality plastic material, they are ultra-light and easy to transport

RESISTENZA

Infrangibili, indeformabili e con elevata elasticità, resistono agli urti anche a bassissime temperature

RESISTANCE

Unbreakable, non-deformable and with high elasticity, they resist to impact even at very low temperatures

PROTEZIONE

La superficie trasparente ed opalescente protegge dalla luce e consente di vedere il prodotto all'interno

PROTECTION

The opalescent and transparent surface protects from light and allows you to see the product inside



COPERCHI E VASSOI IN DIVERSE ALTEZZE E MISURE PER STOCCARE E PROTEGGERE LE VOSTRE CREAZIONI

COVERS AND TRAYS OF DIFFERENT HEIGHTS AND SIZES TO STORE AND PROTECT YOUR CREATIONS

COPERCHI E VASSOI LIDS AND TRAYS

Size cm	Code
59,5x39,5 h 4,2	VC60X404
59,5x39,5 h 6,2	VC60X40
59,5x39,5 h 8,2	VC60X408
30x40 h 6,2	VC30X40

COPERCHI LIDS

Size cm	Code
59x39 h 4	COVER 3H4
59x39 h 4,5	COVER3H45
59x39 h 4,8	COVER3H48
59x39 h 6	COVER 3
59x39 h 8	COVER 8
30x40 h 6	COVER 4



VASSOI TRAYS

Size cm	Code
59,8x39,6 h 2	VASSOIOCMO
39,5x29,8 h 2	VASSOIOBMI

ALTRE MISURE OTHER SIZE

Size cm	Code
59x39,6 h 2,5	VASSOIOCM1
39,5x17,3 h 2	VASSOIOAMO
39,5x20 h 2	VASSOIOAMI
39,5x25,8 h 2	VASSOIOBMO



CHEF WHIP

Sifone per panna Cream whipper

Lo Chef Whip è adatto per la preparazione veloce di panna montata, spugne mousse, dolci, schiume fredde e salse calde e fredde, oltre ad essere ideale per guarnire cappuccini, caffè, dolci e gelati.

The Chef Whip is suitable for the quick preparation of whipped cream, mousse sponges, sweets, cold foams and hot and cold sauces, as well as being ideal for garnishing cappuccinos, coffee, sweets and ice creams.



Il kit comprende: bottiglia, testata, 3 beccucci e porta capsula in acciaio. Guarnizione di testata in silicone.

The kit includes: bottle, head, 3 spouts and steel capsule holder. Silicone head gasket.

500 ml
50SI01
Sifone per panna
Cream whipper

1000 ml
50SI02
Sifone per panna
Cream whipper



RICARICHE PER SIFONE CREAM CHARGES

50SI01
Cartucce per sifone panna NO2
NO2 cream whipper cartridges
Pack 10 pcs

PISTON FUNNEL

Dosatori professionali in acciaio inox ideale per dosare piccole quantità di prodotto nei bicchierini o negli appositi stampi, in modo **facile e senza sprechi**. Ottimo per salse, gelatine, crème brûlée e marmellate liquide, è fornito di un set di bocchette per una migliore applicazione.

Professional stainless steel funnel ideal for dosing small quantities of product in small cups or in the suitable moulds, in an **easy and waste-free way**. Excellent for sauces, jellies, crème brûlée and liquid jams, it is equipped with a set of nozzles for a better application.



50CO001
800 ml
Colino professionale completo: la confezione comprende un piedistallo in metallo e tre bocchette da Ø 2 - 4 - 5 mm.
Complete professional funnel: packaging includes a metal support and three nozzles: Ø 2 - 4 - 5 mm.



50CO002
1900 ml
Colino professionale completo: la confezione comprende un piedistallo in metallo e tre bocchette da Ø 4 - 5 - 6 mm.
Complete professional funnel: packaging includes a metal support and three nozzles: Ø 4 - 5 - 6 mm.

GRIGNOTTINA - COOKIES MAKER

Strumento per creare velocemente ed in modo preciso "roches", biscotti e altri dolci.
Composto da: 1 telaio in plastica senza fondo - 2 teglie forate (Ø30 - 40 mm) - 1 spatola in plastica

Dosing tool to quickly and precisely create "roches", biscuits and other sweets.
Composed of: 1 plastic saucepan without bottom - 2 perforated trays (Ø30 - 40 mm) - 1 plastic spatula

CIOK 1
60x40 h5 cm



RIFRATTOMETRO - REFRACTOMETER

Rifrattometro ottico universale con scala 0-90% Brix, in grado di misurare con precisione, la concentrazione percentuale di sostanze solide, come lo zucchero, in una soluzione fluida.

Universal optical refractometer with 0-90% Brix scale, able to accurately measure the percentage concentration of solid substances, such as sugar, in a fluid solution.

50RI01
Ø3,8 X 14 cm
0-90 % BRIX



BILANCE - SCALES

Precise e facili da usare: pannello touch, funzione tara, indicazione di sovraccarico, indicatore di bassa potenza.
Precise and easy to use: touch panel, tare function, overload indication, low power indicator.



Bilancia piccola - Small scale
50BI01

Superficie in vetro temperato
Tempered glass surface
Div 1g - 0,05oz / 1ml (1/8cup) - max 5 Kg
Batterie incluse - Batteries included
Misura - Size: 22 x 16 cm



Bilancia grande - Big scale
50BI02

Superficie in acciaio inossidabile
Stainless steel surface
Div 1g - 0,05oz - max 15 Kg
Batterie incluse - Batteries included
Misura - Size: 26 x 31 cm

TERMOMETRI - THERMOMETERS

Termometri digitali con sonda o ad infrarossi precisi e funzionali.
Precise and functional thermometers with probe or infrared technology.



Termometro elettronico
Electronic thermometer
50T001

Sonda ad immersione
Dipping probe
Celsius -50°C / 300°C
Fahrenheit -58°F / 572°F



Termometro ad infrarossi
Infrared thermometer
50T002

LCD display
Celsius -50°C / 420°C
Fahrenheit -58°F / 788°F



Termometro digitale
Digital thermometer
50T003

Sonda ad immersione - Display e Timer
Dipping probe - Display and Timer
Celsius 0°C / 250°C
Fahrenheit -32°F / 482°F

CONTAINERS

ISOTHERMAL



GASTRONORM

50CI540GN

Cap. 83 Lt
Internal size: 54 x 33 x 48 cm
External size: 65 x 50 x 61 cm

50x50

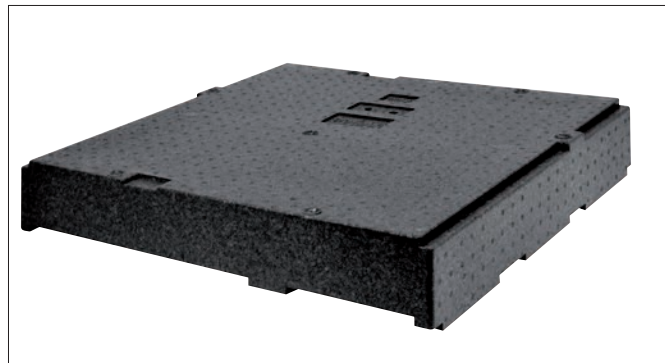

**Terminale
End piece**

50CI5050BC

Internal size: 510x510x63 mm
External size: 570x570x95 mm

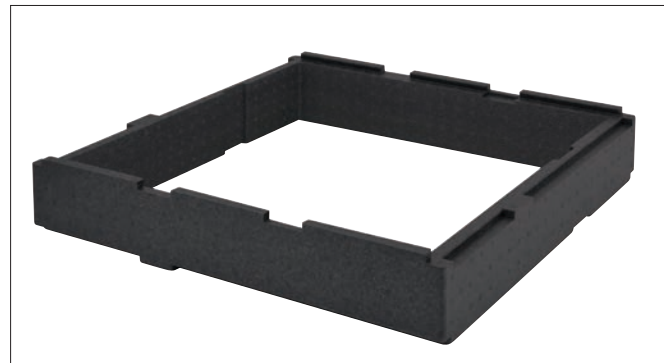

**Estensore
Extensor**

50CI5050ES

Internal size: 510x510x95 mm
External size: 570x570x95 mm



**Piastra eutettica
Eutectic plate**
- 12°C / 0°C

50CIA007

Size: 60 x 40 x 3 cm



**Piastra eutettica
Eutectic plate**
- 6°C / 0°C

50CIA008

Size: 38 x 21,5 x 3 cm

PLASTIC BOX



**Cassa fondo chiuso senza maniglie
Closed bottom case without handles**

50CA604007C

Cap. 12 Lt - 60 x 40 h 7 cm

50CA604010C

Cap. 18 Lt - 60 x 40 h 10 cm

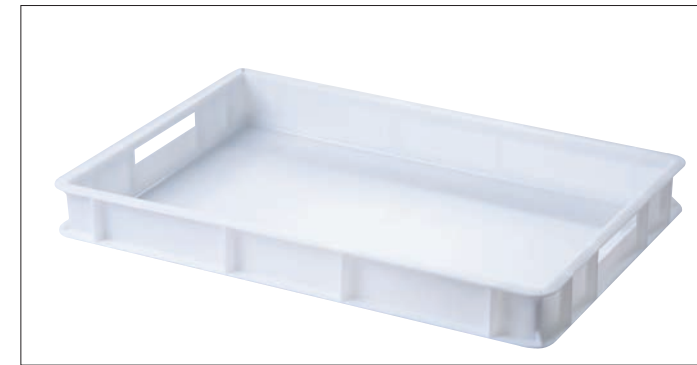

**Cassa fondo chiuso con maniglie
Closed bottom case with handles**

50CA604013C

Cap. 24 Lt - 60 x 40 h 13 cm



**Coperchio per casse 60 x 40
Crate lid 60 x 40**

50CA6040COP

60 x 40 cm

PROFESSIONAL TOOLS



UNA LINEA COMPLETA DI SAC À POCHE MONOUSO
A COMPLETE LINE OF DISPOSABLE PASTRY BAGS

MADE IN ITALY by MARTELLATO



RESISTENTI, ANTISCIVOLO, IGIENICHE, FACILI
DA UTILIZZARE, CON SALDATURA SOTTILE
RESISTANT, NON-SLIP, HYGIENIC, EASY TO USE,
WITH THIN SEAL

ALTA QUALITÀ MADE IN ITALY

Pensate per facilitare il lavoro quotidiano dei professionisti grazie alle caratteristiche dei diversi modelli, le sac à poche monouso Martellato sono conosciute ed apprezzate in tutto il mondo. La produzione è interamente italiana, dalla materia prima accuratamente selezionata alla lavorazione, sotto l'attento controllo di Martellato che, grazie all'impiego delle più **moderne tecnologie** e nel rispetto delle direttive internazionali, è in grado di offrire **sacchetti di alta qualità**.

I NOSTRI PLUS

Velocità e precisione, **presa sicura antiscivolo** e **alta resistenza**, fanno delle sac à poche prodotte da Martellato un prezioso alleato di pasticceri e chef. Un'**unica saldatura, più sottile** per consentire maggiore praticità e **più resistente** per evitarne la rottura durante l'uso, insieme al **materiale multistrato di alta qualità**, garantiscono la durata delle sac à poche per molto tempo, consentendo di riempirle più volte durante l'utilizzo. Possono essere utilizzate con composti caldi e freddi, duri o morbidi e sono adatte per l'utilizzo sia in abbattitore che in microonde.

HIGH QUALITY MADE IN ITALY

Designed to facilitate the daily work of professionals thanks to the characteristics of the different models, the Martellato disposable pastry bags are known and appreciated all over the world.

The production of the pastry bags is entirely Italian, from the raw material to processing, under the careful control of Martellato that, thanks to the use of the most **modern technologies** and in compliance with international directives, can offer **high quality bags**.

OUR PLUS

Speed and precision, non-slip **secure grip** and **high resistance**, make the pastry bags produced by Martellato a precious ally of both confectioners and chefs. **A single seall, thinner** for improved practicality and more resistant to prevent any breakage during use, together with the high quality **multi-layered material**, guarantee these pastry bags last over time, allowing to fill them over and over again during the use. They can be used with hot or cold, hard or soft preparations and are suitable for refrigerators and microwave ovens.

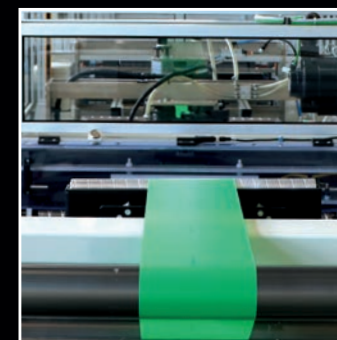
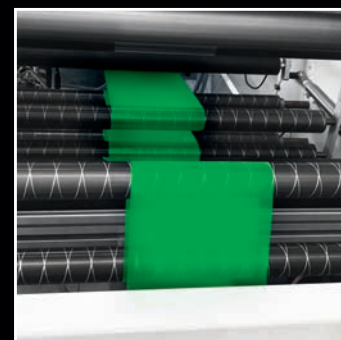

Soft touch: funzionalità e comfort
Soft touch: functionality and comfort

Blue Poche

MADE IN ITALY by MARTELLATO

EXTRA COMFORT

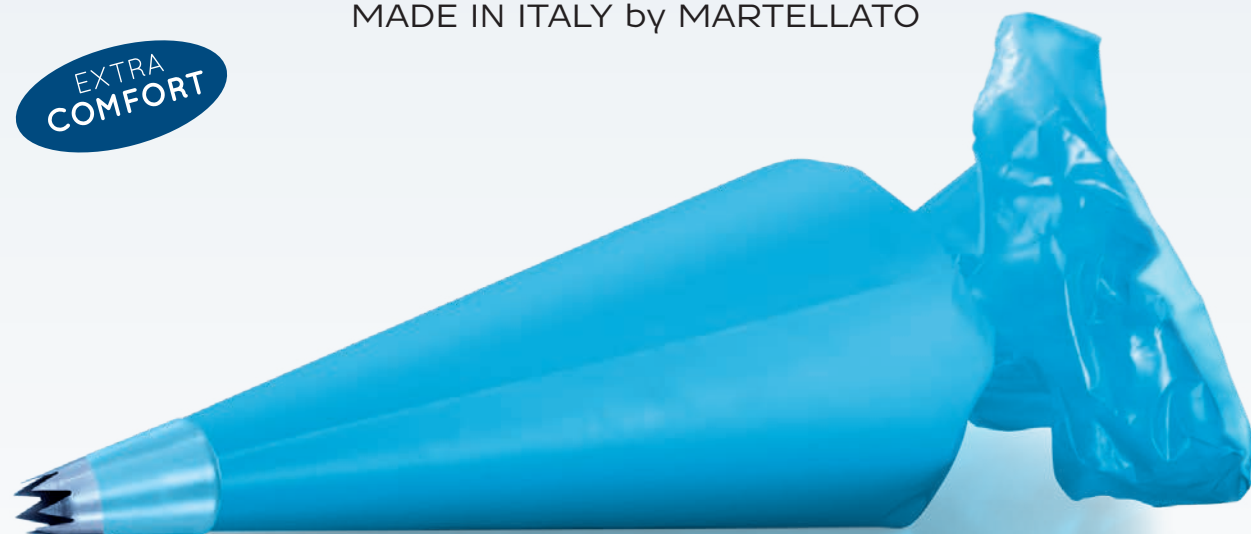

Sacchetti monouso in polietilene multistrato, danno una **piacevole sensazione al tatto** e **maggiore flessibilità**. L'interno liscio facilita la fuoriuscita dei composti caldi, freddi, duri o morbidi.

Disposable pastry bags in multi-layered polyethylene, they give a **pleasant sensation at the touch** and **greater flexibility**. The slick interior facilitates the release of doughs, whether hot, cold, hard or soft.



MYCRON 80 MY

H 30 CM
50-2030
Dispenser box
100 pcs

H 40 CM
50-2040
Dispenser box
100 pcs

H 55 CM
50-2055
Dispenser box
100 pcs

H 65 CM
50-2065
Dispenser box
100 pcs

Antiscivolo, resistente e sicuro: massima qualità
Resistant, non-slip and safe: top quality

Green Poche

MADE IN ITALY by MARTELLATO

GRIP EFFECT



Sacchetti monouso in polietilene **multistrato** verde con rivestimento **antiscivolo all'esterno** pensato per assicurare, anche con mani umide, una presa sicura. All'interno, invece, la superficie è liscia per consentire al prodotto di uscire facilmente.

Disposable pastry bags in green multilayer polyethylene with non-slip coating on the outside designed to ensure a secure grip, even with wet hands. Inside, however, the surface is smooth to allow the product to come out easily.



MYCRON 80 MY

H 30 CM
50-1030
Dispenser box
100 pcs

H 40 CM
50-1040
Dispenser box
100 pcs

H 55 CM
50-1055
Dispenser box
100 pcs

H 65 CM
50-1065
Dispenser box
100 pcs

H 30 CM
50103020STD
Roll 20 pcs

H 40 CM
50104020STD
Roll 20 pcs

H 55 CM
50105520STD
Roll 20 pcs

Trasparente, super resistente: un alleato indispensabile nel tuo laboratorio
 Transparent, super-resistant: an indispensable help in your laboratory

Crystal Poche

MADE IN ITALY by MARTELLATO

SUPER RESISTANT



Sacchetti monouso in polietilene **trasparente extra forte**, adatti anche per gli impasti più duri e **riempibili numerose volte**.

Extra-strong, transparent polyethylene disposable pastry bags, suitable for even the toughest mixes and can be filled many times over.



MYCRON
80
MY

H 30 CM
ROLL H 30
Dispenser box
100 pcs

H 30 CM
ROLLH3020STD
Roll 20 pcs

H 40 CM
ROLL H 40
Dispenser box
100 pcs

H 40 CM
ROLLH4020STD
Roll 20 pcs

H 55 CM
ROLL H 55
Dispenser box
100 pcs

H 55 CM
ROLLH5520STD
Roll 20 pcs

H 65 CM
ROLL H 65
Dispenser box
100 pcs

PRECUT

Sac à poche monouso pretagliati per alimenti in polietilene trasparente, **spessore 80 micron**.
 Disposable precut pastry bags for food made of transparent polyethylene, **80 microns thick**.

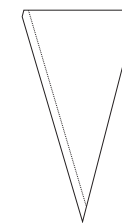

Confezionati in cartone con euroforo.

Size cm	pcs box	Code
23x45	100	SAC45X100

Packed in cardboard boxes with euro-perforation.

Size cm	pcs box	Code
30x55	100	SAC58X100

PORTA SAC À POCHE / PASTRY BAG HOLDER

Vaso porta sac à poche: Accessorio ideale per riporre la sac à poche in uso.

Pastry bag holder: Ideal accessory for storing the pastry bag in use.



50VA001A
Ø200 - h240 mm
Arancione - Orange



50VA001V
Ø200 - h240 mm
Verde - Green

SuperFlex

Simply **unbreakable!**

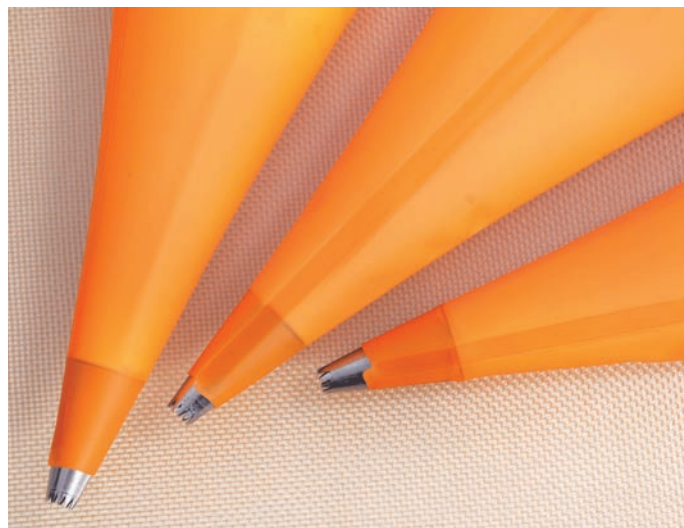

SACCHETTI PER PASTICCERIA RIUTILIZZABILI

Superflex presenta una superficie liscia all'interno, che facilita la fuoriuscita del prodotto, e ruvida all'esterno, per garantire un'impugnatura più sicura. **Elevatissima resistenza alla trazione e facilità di lavaggio** e pulizia, conferiscono una durata di molto superiore a quella degli altri sacchetti in commercio, che utilizzano materiali diversi. Grazie allo **speciale sistema di saldatura del sacchetto**, l'igiene è maggiormente garantita. Non trattiene né assorbe lo sporco e l'impermeabilizzazione è resistente nel tempo, non essendo soggetta ad usura. Resiste fino a 100°C ed è adatto al microonde.



REUSABLE PASTRY BAGS

Superflex has a inner smooth surface which facilitates the release of the cream, and a rough one on the outside in order to ensure a safer handle. **Very tensile strong and easy to wash and clean**, they give a much longer durability than other bags on the market, made of different materials.

Thanks to the **special sealing system of the bag**, hygiene is highly guaranteed. As not subject to wear, the pastry bag neither retain nor absorb dirt and the waterproofing will be resistant over time.

It resists up to 100°C and is suitable for microwave use.



Con Imballo - With package

34 CM
SPR034/C
45 CM
SPR045/C
50 CM
SPR050/C

Senza Imballo - Unpacked

34 CM
SPR034
45 CM
SPR045
50 CM
SPR050



COTTON

Sacchetti per pasticceria riutilizzabili, prodotti con fibre naturali di **cotone** rivestito di poliuretano per dare maggiore resistenza alla pressione, con asola e **punta rinforzata**. **Ideali per impasti più duri.**

Reusable pastry bags made of **natural cotton** fibers coated with polyurethane to give greater resistance to pressure. Turned and sewed rimes, **reinforced tip**.

Ideal for harder doughs.

Size cm	Code
25	STD 025 CM
28	STD 028 CM
34	STD 034 CM
40	STD 040 CM
46	STD 046 CM
50	STD 050 CM
55	STD 055 CM
60	STD 060 CM
65	STD 065 CM
70	STD 070 CM
75	STD 075 CM



FLEX

Sacchetti per pasticceria riutilizzabili, prodotti con fibre di **poliestere** rivestite di poliuretano, con asola.

Reusable pastry bags made of polyurethane coated **polyester** fibers, with welded seam.

Size cm	Code
25	FLEX 025 CM
28	FLEX 028 CM
34	FLEX 034 CM
40	FLEX 040 CM
46	FLEX 046 CM
50	FLEX 050 CM
55	FLEX 055 CM
60	FLEX 060 CM
65	FLEX 065 CM
70	FLEX 070 CM



Piping tips

Ampia gamma di bocchette in acciaio inox prodotte senza saldature per garantire la massima resistenza
Wide range of stainless steel nozzles produced without welding to guarantee maximum resistance

pack 5 pezzi - pieces

Dove non espressamente indicato le confezioni si intendono da **5 pezzi** - le misure sono in millimetri
If not indicated, the package contains **5 pieces** - the measurements are in millimeters

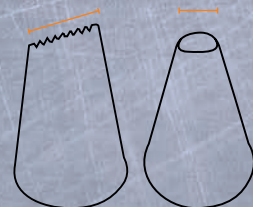
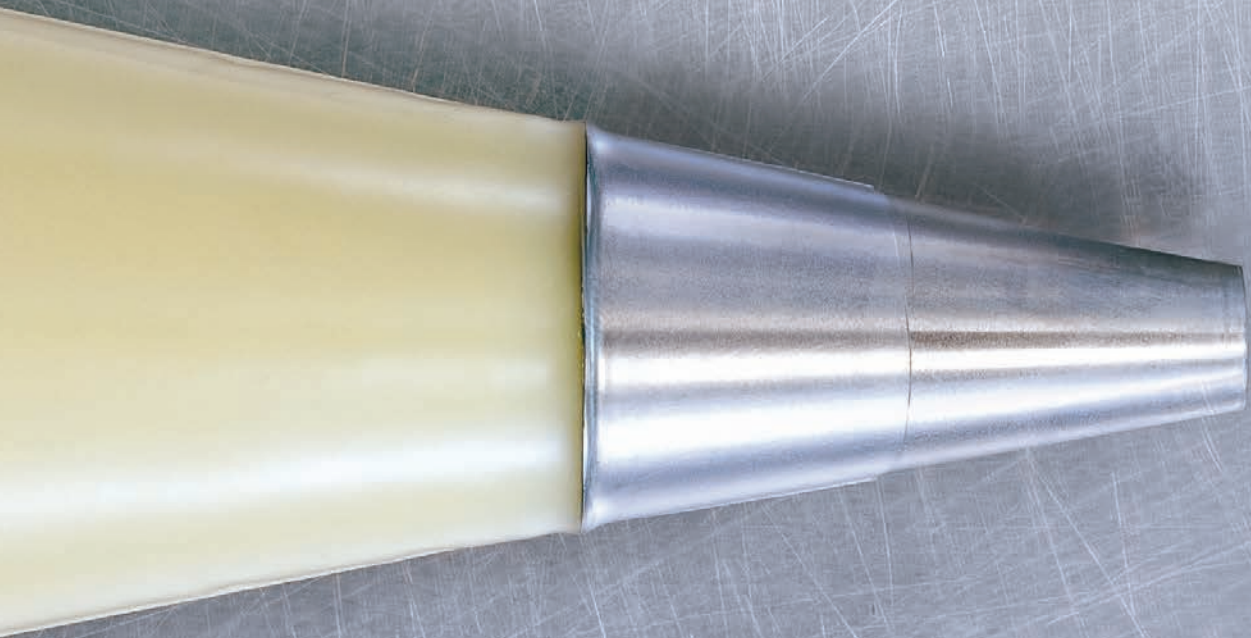

TIP
misura foro di uscita
spout hole size



misure esterne
external size

TONDA - ROUND

Pack 5 pcs



KIT 10 pcs Mix - Ø 4 - 5 - 6 - 7 - 8 - 9 - 10 - 12 - 13 - 15 mm
BS 10 T

TIP Ø2 BT 202 Ø25 h 50	TIP Ø3 BT 203 Ø25 h 50	TIP Ø4 BT 204 Ø25 h 45	TIP Ø5 BT 205 Ø25 h 45	TIP Ø6 BT 206 Ø25 h 45
TIP Ø7 BT 207 Ø25 h 45	TIP Ø8 BT 208 Ø25 h 45	TIP Ø9 BT 209 Ø25 h 45	TIP Ø10 BT 210 Ø30 h 50	TIP Ø11 BT 211 Ø30 h 50
TIP Ø12 BT 212 Ø30 h 47	TIP Ø13 BT 213 Ø30 h 47	TIP Ø14 BT 214 Ø30 h 47	TIP Ø15 BT 215 Ø35 h 50	TIP Ø16 BT 216 Ø35 h 50
TIP Ø17 BT 217 Ø35 h 50	TIP Ø18 BT 218 Ø35 h 50	TIP Ø20 BT 220 Ø35 h 47	TIP Ø22 BT 222 Ø35 h 47	TIP Ø24 BT 224 Ø35 h 43

STELLA APERTA - OPEN STAR

Pack 5 pcs



KIT 10 pcs Mix - Ø 4 - 5 - 6 - 7 - 8 - 9 - 10 - 12 - 13 - 15 mm
BS 10 S

TIP Ø2 BS 102 Ø25 h 50	TIP Ø3 BS 103 Ø25 h 50	TIP Ø4 BS 104 Ø25 h 50	TIP Ø5 BS 105 Ø25 h 50	TIP Ø6 BS 106 Ø25 h 45
TIP Ø7 BS 107 Ø25 h 50	TIP Ø8 BS 108 Ø25 h 45	TIP Ø9 BS 109 Ø25 h 40	TIP Ø10 BS 110 Ø30 h 50	TIP Ø11 BS 111 Ø30 h 50
TIP Ø12 BS 112 Ø30 h 50	TIP Ø13 BS 113 Ø30 h 50	TIP Ø14 BS 114 Ø35 h 55	TIP Ø15 BS 115 Ø35 h 50	TIP Ø16 BS 116 Ø35 h 50
TIP Ø17 BS 117 Ø35 h 50	TIP Ø18 BS 118 Ø35 h 50			

STELLA FRANCESE - FRENCH STAR

Pack 5 pcs



TIP Ø4 BF 310 Ø25 h 45	TIP Ø6 BF 311 Ø25 h 45	TIP Ø7 BF 312 Ø25 h 45	TIP Ø9 BF 313 Ø25 h 45	TIP Ø10 BF 314 Ø30 h 50
TIP Ø11 BF 314/11 Ø30 h 50	TIP Ø12 BF 315 Ø30 h 45	TIP Ø13 BF 316 Ø30 h 50	TIP Ø15 BF 317 Ø35 h 50	TIP Ø16 BF 318 Ø35 h 50
TIP Ø18 BF 319 Ø35 h 50	TIP Ø16 BF 0867 Ø35 h 50	TIP Ø20 BF 0869 Ø35 h 48		

STELLA CHIUSA - CLOSED STAR

Pack 5 pcs



TIP Ø2 BC 320 Ø25 h 47	TIP Ø3 BC 321 Ø25 h 47	TIP Ø4 BC 322 Ø25 h 47	TIP Ø5 BC 323 Ø25 h 47	TIP Ø6 BC 324 Ø25 h 43
TIP Ø7 BC 325 Ø35 h 50	TIP Ø8 BC 326 Ø30 h 50	TIP Ø9 BC 327 Ø30 h 50	TIP Ø10 BC 328 Ø35 h 53	TIP Ø11 BC 329 Ø35 h 50
TIP Ø12 BC 330 Ø35 h 50				

FANCY PIPING NOZZLES

Pack 5 pcs



TIP Ø5 BX 1820 - Ø30 H 42
TIP Ø23 BX0001 - Ø37 H 42
TIP Ø23 BX0009 - Ø37 H 42
TIP Ø20 BX 0252 - Ø30 H 40
TIP Ø20 BX 0250 - Ø30 H 40



TIP Ø 0,4 BX0028 - Ø18 H 37
TIP Ø 0,6 BX0029 - Ø18 H 35
TIP Ø 0,9 BX0030 - Ø18 H 36
TIP Ø4 BX0031 - Ø18 H 34
TIP 4x4 BX0032 - Ø18 H 34



TIP 3x3 BX0033 - Ø18 H 33
TIP 5x5 BX0034 - Ø18 H 33
TIP Ø8 BX0038 - Ø18 H 28
TIP Ø9 BX0047 - Ø18 H 26
TIP Ø5 BX0042 - Ø18 H 30



TIP Ø7 BX0045 - Ø18 H 31
TIP Ø10 BX0046 - Ø18 H 30
TIP Ø2 BX0048 - Ø18 H 30

BASKET PIPING NOZZLES



TIP 17 BX 9017 Ø30 h 50
TIP 20 BX 9022 Ø30 h 45
TIP 16x2 BD 300 Ø25 h 40
TIP 20x3 BD 301 Ø30 h 43
TIP 27 BD 302 Ø35 h 45

STRIPES & BORDER

Pack 5 pcs



TIP Ø10 BX9990 - Ø30 H 50
TIP Ø12 BX9991 - Ø30 H 50
TIP Ø14 BX9992 - Ø30 H 50



TIP Ø13 L20 BX 2312 - Ø25 H 40
TIP Ø12 L16 BX 2314 - Ø25 H 40
TIP Ø14 L20 BX 2315 - Ø30 H 45



TIP Ø13 L25 BX 1510 - Ø30 H 45
TIP 16 BX 1303 - Ø25 H 40
TIP 18x4 BX 1217 - Ø25 H 37



TIP 19x2 BX 0119 - Ø25 H 40
TIP 12x3 BX 1906 - Ø35 H 45
TIP 15x2 BX 0134 - Ø25 H 42



TIP Ø5 BX 3005 - Ø35 H 50
TIP 15x5 BX 0158 - Ø25 H 45
TIP 25 BX0026 Ø18 h 36
TIP 25 BX0027 Ø18 h 36
TIP Ø5 BX0039 Ø18 h 32
TIP 10 BX0043 Ø18 h 28
TIP Ø6 BX0040 Ø18 h 30



pack 5 pezzi - pieces

FLOWER & PETALS NOZZLES

Pack 5 pcs



Floral piping tips

Pack 5 pcs



BOS12FLO
Box 12 pcs



Sphere ball piping tips



TIP Ø22
BX0100
Ø32 h 60 TIP Ø22
Pack 1 pc

TIP Ø22
BX0101
Ø32 h 57
Pack 1 pc

TIP Ø22
BX0102
Ø32 h 57 TIP Ø22
Pack 1 pc

TIP Ø22
BX0103
Ø32 h 57 TIP Ø22
Pack 1 pc

TIP Ø22
BX0104
Ø32 h 57 TIP Ø22
Pack 1 pc

FILLING NOZZLES

TIP Ø4
BIM 340
Ø25 h 90
Pack 5 pcs



TIP Ø8
BIM 232
Ø25 h 95
Pack 5 pcs



TIP Ø6
BIM 230
Ø5 h 75
Pack 5 pcs



TIP 31
BXB01
Ø55 h 60 TIP Ø31
pack 1 pc



TIP 31
BXB02
Ø55 h 56 TIP Ø31
pack 1 pc



ADAPTERS



Piccolo - Small
50AD001
pack 1 pc
base Ø18 mm



Medi - Medium
50AD002
kit 2 pcs
base Ø25 - Ø31 mm



Grande - Large
50AD003
pack 1 pc
base Ø36mm



Floreal & Sphere Ball
50AD004
pack 2 pcs
Per bocchette a sfera e floreali
For sphere ball and floreal tips

Bi & Tri COLOR

Kit di adattatori, per realizzare decorazioni a due o tre colori.
Adapter kit suitable to prepare decorations with two or three colours.



BI & TRI COLOR
40-WA010
pack 2 pcs
Adatto a bocchette Ø30 h 50
Suitable for piping tips Ø30 h 50



Big Size
BOSPL1
Box 12 pcs
Plastica - Plastic



Scatola - Box
BOSPL3
Box 20 pcs
Bocchette in plastica - con adattatore
Plastic piping tips - with adapter



Kit 6 Pezzi
BPL6
6 pcs
Plastica - Plastic



Bruschino - Brush

BRU
Setole in nylon ed impugnatura in plastica.
Forma conica ideale per la pulizia di tutti i modelli di bocchetta.

Nylon bristles and plastic handle.
Conical shape ideal for cleaning all the nozzle models.



Bocchette miste
Mixed piping tips
BOS 36 BIG
h 50 mm
il kit include:
36 bocchette miste
3 adattatori
pratica scatola in plastica

the kit includes:
36 mixed piping tips
3 adapters
practical plastic box

Bocchette da decorazione
Decorative piping tips

BOS 52
h 33 mm

il kit include: 52 bocchette miste - 1 adattatore
2 chiodi per fiori - pratica scatola in plastica

the kit includes: 52 mixed piping tips - 1 adapter
2 nails for flowers - practical plastic box



Bocchette da decorazione
Decorative piping tips

BOS 26

h 33 mm
il kit include: 26 bocchette miste - 1 adattatore
2 chiodi per fiori - pratica scatola in plastica

the kit includes: 26 mixed piping tips - 1 adapter
2 nails for flowers - practical plastic box



Espositore in plexiglass
Plexiglass display

ESPOB60
Size: 515x315 h210mm
cap. 60 bocchette/piping tips
con crowner/with crowner



Portabocchette in plexiglass
con anta protettiva
Plexiglass piping tips holder
with protective door

ESPOB032
Size: 310x100 h390mm

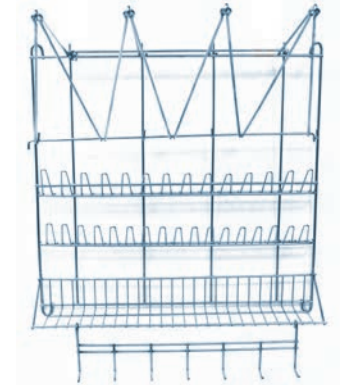

Espositore per bocchette
e sacchetti
Wall rack for piping tips
& pastry bags

Size: 510x350 h490mm

ESPO ST
Inox - Stainless steel



Le più iconiche tra le sac à poche prodotte da Martellato sono proposte in una inedita confezione da 20 pezzi, per rispondere alle diverse richieste dei professionisti.

Gli esclusivi box in plexiglass ne consentiranno l'esposizione nei punti vendita o lo stoccaggio organizzato in laboratorio.

The most iconic among the Martellato's sac a poche are now available in a brand new 20-piece package, to meet the different needs of professionals.

The exclusive plexiglass boxes will allow them to be displayed at points of sale or stored in the laboratory.

for ROLL H 30 CM
ESPOP30
190x250 h 210 mm
cap. 18 pcs

for ROLL H 55 CM
ESPOP55
310x250 h 260 mm
cap. 18 pcs

for ROLL H 40 CM
ESPOP40
250x250 h 230 mm
cap. 18 pcs

TOP Spatula Pro

HIGH TEMPERATURE SPATULA



50SC350

Total 350x65 mm
Manico/Handle 235 mm
bianca con manico nero
white with black handle

50SC400

Total 400x65 mm
Manico/Handle 285 mm
bianca con manico nero
white with black handle



Spatole professionali per alte temperature multiuso di alta qualità con cucchiaio in silicone ed impugnatura ergonomica in plastica. Progettate per resistere alle alte temperature **fino a 230°C (446°F)**, la loro speciale impugnatura in fibra di vetro e nylon garantisce il comfort di una presa sicura durante l'uso.

High temperatures Spatulas, high quality, professional and multi-purpose with silicone blade and ergonomic nylon handle. That spatulas are designed to resist heat **up to 230°C (446°F)**. The sure-grip handle ensures a solid grip during use, increasing safety while maintaining comfort.

SPATOLE MORBIDE IN PLASTICA SOFT PLASTIC SPATULAS

Spatola professionale bicomponente con cucchiaio in gomma e manico in ABS. Resistente a temperature **fino a 70°C**.
Professional two-component spatula with rubber spoon and ABS handle.
Temperature resistant **up to 70°C**.



50GO300

Manico - Handle 195 mm
Total size 310x70 mm
bianca - white

50GO350

Manico - Handle 235 mm
Total size 350x70 mm
bianca - white

50GO400

Manico - Handle 285 mm
Total size 400x70 mm
bianca - white



50GO275

Manico - Handle 187 mm
Total size 275x49 mm
bianca - white
extra soft

Spatola professionale con anima interna rivestita in materiale termoplastico morbido. Resistente a temperature **fino a 70°C**.
Professional spatula with internal core covered in soft thermoplastic material.
Resistant to temperatures **up to 70°C**.



50SG250B

Manico - Handle 170 mm
Total size 254x42 mm
bianca - white

50SG250V

Manico - Handle 170 mm
Total size 254x42 mm
verde - green

50SG350B

Manico - Handle 237 mm
Total size 355x59 mm
bianca - white

Spatola professionale bicomponente con cucchiaio in gomma termoplastica e manico in plastica resistente rigida. Resistente a temperature **fino a 70°C**.
Professional two-component spatula with thermoplastic rubber spoon and rigid resistant plastic handle. Resistant to temperatures **up to 70°C**.



MEL 250

Manico - Handle 165 mm
Total size 250 mm
bianca - white

MEL 350

Manico - Handle 235 mm
Total size 350 mm
bianca - white

MEL 450

Manico - Handle 335 mm
Total size 450 mm
bianca - white

SPATOLE RIGIDE IN PLASTICA HARD PLASTIC SPATULAS

Spatola rigida monopezzo in PP con fibre di vetro, resistente a temperature **fino a 70°C**.
Cucchiaio rettangolare sottile, manico ergonomico con foro per l'appendimento.
One-piece rigid spatula in PP with fiberglass, resistant to temperatures **up to 70° C**.
Thin rectangular spoon, ergonomic handle with hole for hanging.



50SR340
Manico - Handle 239 mm
Total size 339x59 mm
bianca - white

Spatola rigida monopezzo, materiale ABS bianco resistente a temperature **fino a 70°C**.
Cucchiaio rigido, tre lunghezze di manico con foro per l'appendimento.
One-piece rigid spatula, white ABS material resistant to temperatures **up to 70°C**.
Rigid spoon, three lengths handles with hole for hanging.



SCM 30
Manico - Handle 195 mm
Total size 300x55 mm
bianca - white

SCM 35
Manico - Handle 240 mm
Total size 345x55 mm
bianca - white

SCM 40
Manico - Handle 295 mm
Total size 400x55 mm
bianca - white

Spatola rigida monopezzo, materiale ABS bianco resistente a temperature **fino a 70°C**.
Cucchiaio liscio extra forte, punta stondata, manico ergonomico con foro per l'appendimento.
One-piece rigid spatula, white ABS material resistant to temperatures **up to 70° C**.
Extra strong smooth spoon, with rounded tip, ergonomic handle with hole for hanging.



50SP300B
Manico - Handle 208 mm
Total size 300x48 mm
bianca - white

50SP350B
Manico - Handle 254 mm
Total size 350x53 mm
bianca - white

50SP400B
Manico - Handle 301 mm
Total size 400x58 mm
bianca - white

Spatola rigida monopezzo, materiale poliammide con fibre di vetro, resistente a temperature **fino a 220°C**.
One-piece rigid spatula, polyamide with fiberglass material, resistant to temperatures **up to 220° C**.



MEX 250
Manico - Handle 130 mm
Total size 250 mm
bianca - white

MEX 300
Manico - Handle 180 mm
Total size 300 mm
bianca - white

MEX 400
Manico - Handle 255 mm
Total size 400 mm
bianca - white

MEX 500
Manico - Handle 290 mm
Total size 500 mm
bianca - white

Spatole con cucchiaio cavo in gomma e manico in resistente materiale termoplastica.
Resistente a temperature **fino a 70°C**.
Spatulas with rubber hollow spoon and handle in resistant thermoplastic material.
Resistant to temperatures **up to 70°C**.



MSP 250
Manico - Handle 160 mm
Total size 250 mm
bianca - white

MSP 350
Manico - Handle 260 mm
Total size 350 mm
bianca - white

Spatole professionali rigide monopezzo, materiale ABS bianco resistente a temperature **fino a 70°C**.
One-piece hard professional spatulas, white ABS material resistant to temperatures **up to 70°C**.



50SA150B
Manico - Handle 180 mm
Total size 324x40 mm
bianca - white

50SA250B
Manico - Handle 180 mm
Total size 424x40 mm
bianca - white



50SL300B
Manico - Handle 156 mm
Total size 300x30 mm
bianca - white

50SL370B
Manico - Handle 161 mm
Total size 370x40 mm
bianca - white

SPATOLE IN ACCIAIO ST. STEEL SPATULAS

Spatole professionali con lama dritta o angolare in acciaio inox. Lama rigida per distribuire uniformemente anche ganache più dure ma flessibile per un glassaggio ottimale. Manico realizzato in robusta plastica, ergonomico e antiscivolo, progettato con speciale appoggio per il pollice, ideale per una presa confortevole e sicura.

Professional spatulas with stainless steel straight or angular blade. Sturdy blade to spread also harder ganache but flexible for optimal glazing. Handle made of resistant plastic, ergonomic and anti-slip, with a special thumb support, for a comfortable and secure grip.



50SPANG01

Manico - Handle 133 mm
Lama - Blade 32x102 mm

50SPANG02

Manico - Handle 133 mm
Lama - Blade 32x155 mm

50SPANG03

Manico - Handle 133 mm
Lama - Blade 32x205 mm

50SPANG04

Manico - Handle 133 mm
Lama - Blade 32x255 mm



50SPA01

Manico - Handle 133 mm
Lama - Blade 32x105 mm

50SPA02

Manico - Handle 133 mm
Lama - Blade 32x160 mm

50SPA03

Manico - Handle 133 mm
Lama - Blade 32x210 mm

50SPA04

Manico - Handle 133 mm
Lama - Blade 32x260 mm

FRUSTE PROFESSIONALI PROFESSIONAL WHISKS

Interamente realizzata in acciaio inox, 8 robusti fili d. 2,2 mm. Resistente ad alte temperature.
Entirely made of stainless steel, 8 sturdy wires d. 2.2 mm. Resistant to high temperatures.

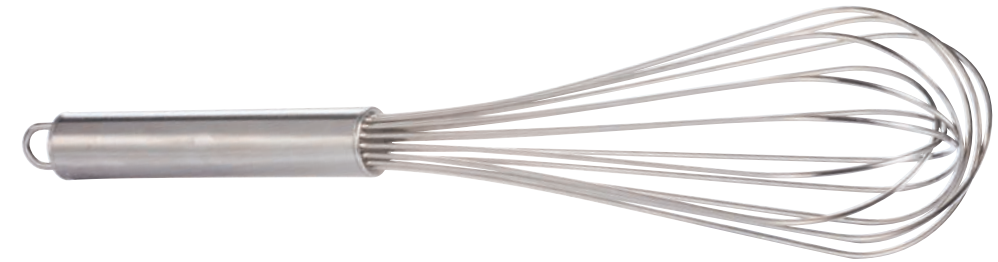

50FA01

Total size: 25 cm

50FA02

Total size: 30 cm

50FA03

Total size: 35 cm

50FA04

Total size: 40 cm

50FA05

Total size: 45 cm

50FA06

Total size: 50 cm

Manico antiscivolo in plastica rinforzato con fibra di vetro, 16 fili sottili in acciaio inox.
Resistente ad alte temperature.

Glass fiber reinforced plastic non-slip handle, 16 thin stainless steel wires. Resistant to high temperatures.



TFRU 25

Total size: 25 cm
Filo - wire Ø 1,5 mm

TFRU 30

Total size: 30 cm
Filo - wire Ø 1,8 mm

TFRU 35

Total size: 35 cm
Filo - wire Ø 1,8 mm

TFRU 40

Total size: 40 cm
Filo - wire Ø 1,8 mm

TFRU 45

Total size: 45 cm
Filo - wire Ø 2 mm

TFRU 50

Total size: 50 cm
Filo - wire Ø 2 mm

Manico in plastica rinforzato con fibra di vetro, 16 fili sottili in acciaio inox. Resistente ad alte temperature.
Glass fiber reinforced plastic handle, 16 thin stainless steel wires. Resistant to high temperatures.



MFRU 25

Total size: 25 cm
Filo - wire Ø 1,5 mm

MFRU 30

Total size: 30 cm
Filo - wire Ø 1,8 mm

MFRU 35

Total size: 35 cm
Filo - wire Ø 1,8 mm

MFRU 40

Total size: 40 cm
Filo - wire Ø 1,8 mm

MFRU 45

Total size: 45 cm
Filo - wire Ø 2 mm

MFRU 50

Total size: 50 cm
Filo - wire Ø 2 mm

Professional Choco SCRAPERS



Le nuove raschie progettate e prodotte in Italia da Martellato rispondono alle esigenze dei cioccolatieri più attenti. Composte da una robusta **LAMA RIGIDA** in **ACCIAIO INOX** e proposte in differenti misure ed altezze per le diverse esigenze: **CORTA** per una maggiore sensibilità della mano o **LUNGA** per maggiore superficie di lavoro. Il **MANICO SAGOMATO** in plastica **ANTISCIVOLO** è adatto a diverse impugnature e avvolge la lama per una completa sicurezza ed igiene.

The new scrapers designed and produced in Italy by Martellato meet the needs of the most demanding chocolatiers. Composed of a sturdy **STAINLESS STEEL RIGID BLADE** and proposed in different sizes and heights for different needs: **SHORT** for greater sensitivity of the hand or **LARGE** for greater working surface. The **ANTI-SLIP SHAPED** plastic **HANDLE** is suitable for different grips and it wraps the blade for maximum safety and hygiene.



MODELLI - MODELS

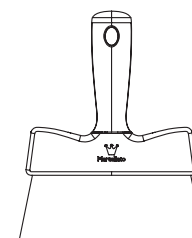

50RAS4
Total size: 180x145 mm
Manico - Handle: h 130x135,4 mm
Lama - Blade: 145 x h 50 mm

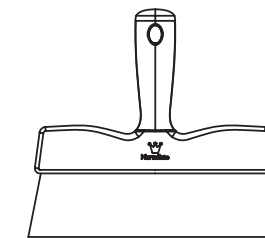

50RAS6
Total size: 180x200 mm
Manico - Handle: h 130x189,7 mm
Lama - Blade: 200 x h 50 mm

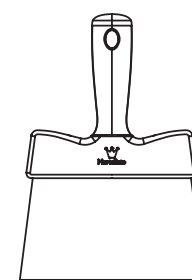

50RAS5
Total size: 210x145 mm
Manico - Handle: h 130x135,4 mm
Lama - Blade: 145 x h 80 mm

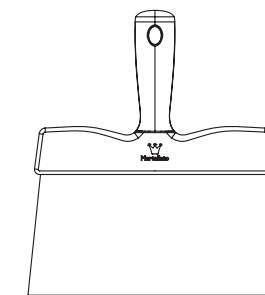

50RAS7
Total size: 225x200 mm
Manico - Handle: h 130x189,7 mm
Lama - Blade: 200 x h 95 mm

RASCHIE IN METALLO - METAL SCRAPERS

Raschie e spatole taglia impasto con lama in acciaio inox e manico in plastica.
Scrapers and spatulas for cutting dough with stainless steel blade and plastic handle



5ORAS1 5ORAS2
130 h105 175 h105

Lama Blade: Acciaio inox - Stainless steel
Spessore - Thickness 0,40 mm
Altezza - Height 80 mm

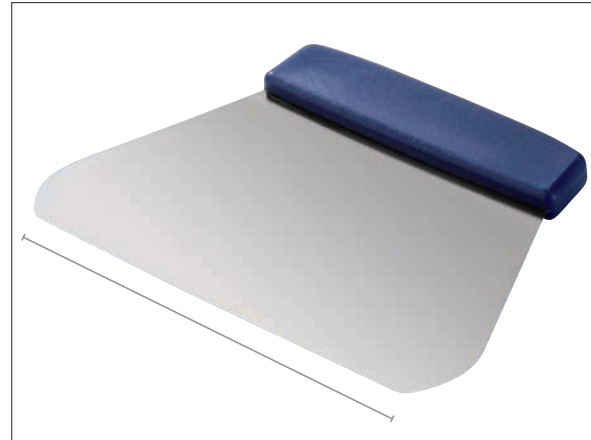

RAS 3
195 h145

Impugnatura in plastica - Plastic handle
Lama Blade: Acciaio inox - Stainless steel
Spessore - Thickness 0,50 mm
Altezza - Height 110 mm

TAGLIA IMPASTO - DOUGH CUTTERS

Spatole taglia impasto con impugnatura rotonda

Acciaio inox - Stainless steel
Altezza - Height 80 mm

Acciaio inox - Stainless steel
Altezza - Height 60 mm

Acciaio inox - Stainless steel
Altezza - Height 60 mm

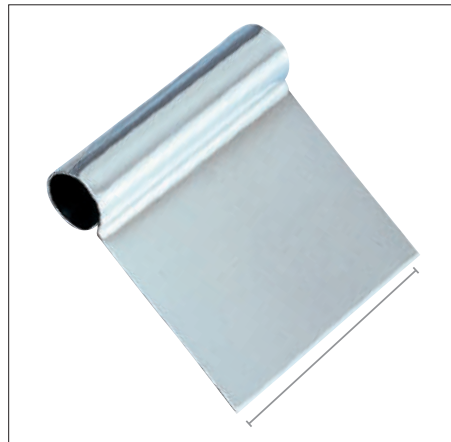

RD105 RD125
105 x h105 125 x h105

RD150 RD175
150 x h105 175 x h105



RC115
120 x h115

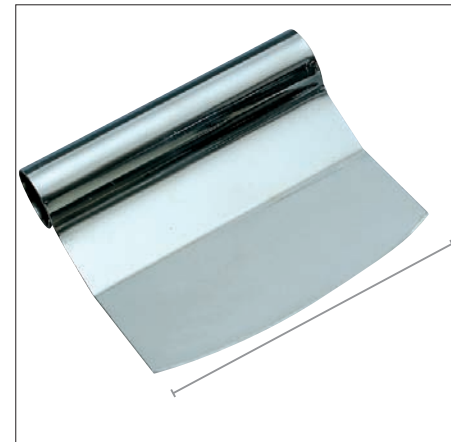

RC110
h110

RASCHIETTI IN PLASTICA - PLASTIC SCRAPERS

Raschietti in plastica per creme ed altri impasti. Confezioni 10 pezzi.
Plastic scrapers for creams and other doughs. Packs of 10 pcs.



145x95 MM
50RTD1
Rigido - Rigid



150x110 MM
50RTF1
Rigido - Rigid
50RTF2
Morbido - Soft



145x95 MM
50RTL1
Rigido - Rigid
50RTL2
Morbido - Soft



120x90 MM
50RTP1
Rigido - Rigid
50RTP2
Morbido - Soft



125x90 MM
50RTA1
Rigido - Rigid
50RTA2
Morbido - Soft



140x90 MM
50RTO1
Rigido - Rigid
50RTO2
Morbido - Soft



150x150 MM
50RTV1
Rigido - Rigid
50RTV2
Morbido - Soft



BIG SIZE
215x130 MM
50RTT1
Rigido - Rigid



BIG SIZE
195x150 MM
50RTS1
Rigido - Rigid

COLTELLI PROFESSIONALI PROFESSIONAL KNIVES

Robusta lama in acciaio inox temperato made in Italy. Manico ergonomico in polipropilene, materiale igienico, atossico e resistente in lavastoviglie. Confezione in blister sicuri.

Sturdy blade in tempered stainless steel, made in Italy. Ergonomic polypropylene handle, hygienic, non-toxic and dishwasher safe material. Secure blister packaging.



Spelucchino 9 - Paring 9

50COL01

Lama - Blade: 90mm



Pasticceria 30 - Pastry 30

50COL02

Lama - Blade: 300mm



Cuoco 26 - Chef 26

50COL04

Lama - Blade: 260mm



Cuoco 30 - Chef 30

50COL05

Lama - Blade: 300mm



Salati e formaggi 26 - Salty and cheese 26

50COL06

Lama - Blade: 260mm



Pane e panettone 25 - Bread and panettone 25

50COL07

Lama - Blade: 250mm

PINZE CHEF CHEF TWEEZERS

Pinza professionale da cucina, caratterizzata dal design ergonomico, per una sicura e comoda maneggevolezza, che la rende adatta anche a decori e cibi più delicati.

Estremità antiscivolo, perfettamente allineate per afferrare con la massima precisione. Pratica e comoda impugnatura con grip antiscivolo, garantisce una presa sicura e ferma. Realizzata in acciaio inox di alta qualità, lavabile in lavastoviglie.

Professional cooking tweezer, the ergonomic design for safe and comfortable handling makes it suitable for delicate decorations and foods. Non-slip ends, perfectly aligned, can precisely grab small detailed items with maximum precision without slipping. Practical and comfortable thanks to the ridged handle that ensures a secure grip. Made of high quality stainless steel, dishwasher safe.



50PI03 30 cm

50PI02 20 cm



50PI05 30 cm

50PI04 20 cm



50PI01 16 cm

GRATER & ZESTER

Ideale per cioccolato, formaggio, agrumi e altro. Lama in acciaio, manico soft touch antiscivolo, custodia protettiva.

Ideal for chocolate, chees, citrus and more. **Stainless steel** blade, **non slip soft** handle, blade cover for save storage.

Giallo - Yellow

50ZES01



Rosso - Red

50ZES02



Nero - Black

50ZES03



PENNELLI - PASTRY BRUSHES

Pennello professionale per cucina: pennello multiuso con setole di alta qualità e impugnatura in plastica combinata a gomma, per una maggiore comodità. Resistente fino a 120°C. Lavabile in lavastoviglie. Made in Italy.

Professional cooking brush: multi-purpose brush with high quality bristles and comfortable handle in plastic and rubber. Heat resistant up to 120°C. Dishwasher safe. Made in Italy.



50PE30
30 mm

50PE40
40 mm

50PE50
50 mm

50PE60
60 mm

50PE70
70 mm

PINZE - PINCERS



PINZAX1
Pinze in acciaio inox
St. Steel pincers
190x17mm

PINZAX2
Pinze in acciaio inox
St. Steel pincers
190x36mm

PINZAX3
Pinze in acciaio inox
St. Steel pincers
190x38mm

PINZAX4
Pinze in acciaio inox
St. Steel pincers
190x58mm

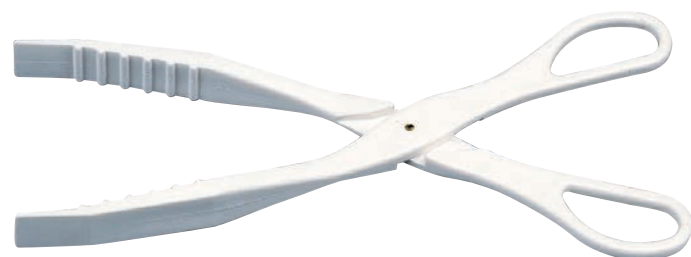

PINZA
Pinza in plastica
Plastic pincer
295x80mm

GRIGLIE - RACKS

Griglia di raffreddamento ideale per **glassare** e **raffreddare** torte. Resistente alle alte temperature. Cromata, con piedini per facilitare il lavoro. Lavabile in lavastoviglie.
Cooling grid ideal for **cooling** and **glazing** cakes. Resistant to high temperatures. Made of chromed iron with raised base to facilitate work. Dishwasher safe.



Ø30 CM
PR30

Ø40 CM
PR40

30x30 CM
PR30X30

50x50 CM
PR50X50

60x39 CM
PR40X60

Piedini più alti, perfetta per essere utilizzata con le teglie. Higher feet, perfect for use with trays.

SETACCI - SIEVES

Setacci in acciaio inox per farina. Trama setaccio 0,50 mm.
Stainless steel sieves for flour. Sieve weft 0,50 mm



Ø30 CM
SETAC30

Ø28 CM
SETAC28

Ø26 CM
SETAC26

Ø24 CM
SETAC24

Ø21 CM
SETAC21

Ø19 CM
SETAC19

Ø16 CM
SETAC16

Spargi Polvere

Diffusori a maglia fine con tappo a vite. Ideali per spolverare zucchero a velo e farina o aggiungere spezie e cacao. Il coperchio a rete fine diffonde il contenuto in modo leggero e uniforme, è sicuro e facile da rimuovere per riempire di nuovo il barattolo. Realizzati in acciaio inossidabile con una copertura di plastica ermetica per proteggere il contenuto.

Mesh Shaker

Fine mesh shakers with a screw cap. Ideal for sprinkling icing sugar and flour or adding spices and cocoa. The fine mesh lid spreads contents lightly and evenly, it is safe and easy to remove to refill the can. Made from stainless steel with an airtight plastic cover to protect the contents.



cap. 450 g
SETACIOK2
Ø73 h120mm

TAGLIAPASTA ESTENSIBILE EXPANDABLE WHEELS CUTTER

Tagliapasta estensibile in acciaio, consente di tagliare in modo rapido e preciso strisce di impasti della stessa misura. Disponibile anche in versione doppia con lame dritte su un lato e alette scanalate sul retro. La distanza delle ruote è facilmente regolabile per ottenere strisce dai 10 ai 120 mm. Diametro ruota 5,5 cm. Le ruote possono essere bloccate nella posizione desiderata stringendo i dadi ad alette. Stoccaggio facile.

Extensible steel dough cutter, it allows to cut quickly and precisely strips of dough of the same size. Also available in double version with straight blades on one side and grooved blades on the back. The distance of the wheels is easily adjustable to obtain strips from 10 to 120 mm. Wheel diameter 5,5 cm. The wheels can be locked in the desired position by tightening the wing nuts. Easy storage.

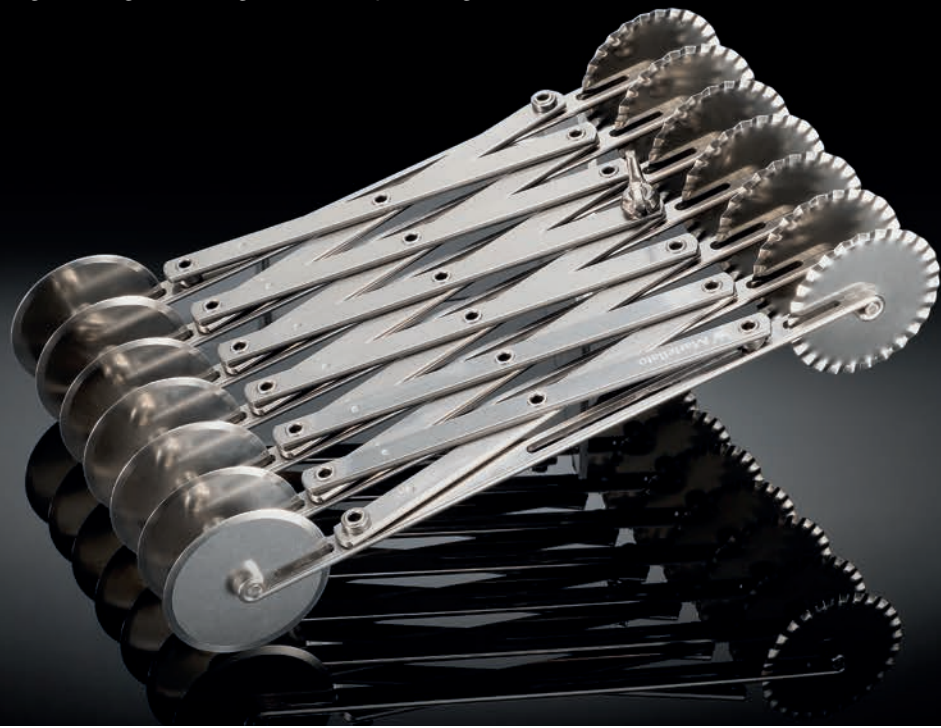

5 Lame lisce - Straight Blades
ROTAPINOX 5 P



5 Lame ondulate - Curved Blades
ROTAPINOX 5 O



5 Lame ondulate - Curved Blades
5 Lame lisce - Straight Blades
ROTINOX 5 P/O



7 Lame lisce - Straight Blades
ROTAPINOX 7 P



7 Lame ondulate - Curved Blades
ROTAPINOX 7 O



7 Lame ondulate - Curved Blades
7 Lame lisce - Straight Blades
ROTINOX 7 P/O

RULLI FORAPASTA - CUTTING DOCKER

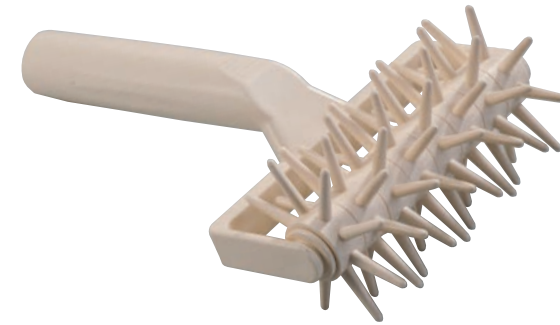

Rullo in plastica forapasta
Plastic spiked roller

6 CM 12 CM
RFP 6 RFP 12



Rullo in plastica per losanghe
Plastic lattice cutting rollers

6 CM 12 CM
RPL 6 RPL 12

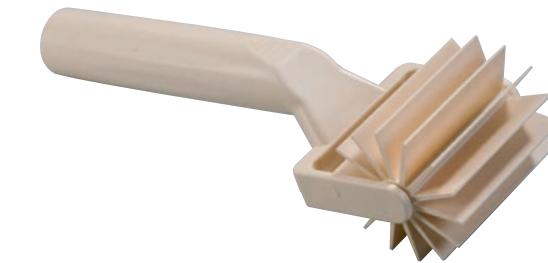

Rullo in plastica a lamelle
Plastic cutting roller

6 CM
RPS 6

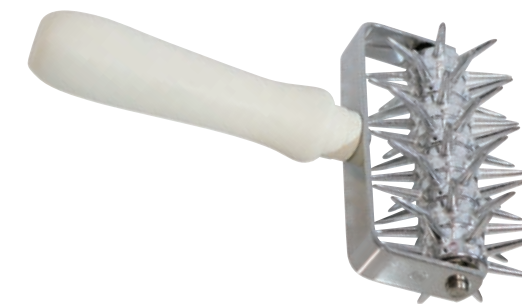

Rullo forapasta in alluminio
Aluminum spiked roller

12 CM
RFP12INOX



Rullo in acciaio inox per losanghe
St. Steel lattice cutting roller

12 CM
RPL12INOX
Distanza tra lame 7 mm
Distance between blade 7 mm



Rotella tagliapasta
Pastry cutters

Ø 5,5 CM Ø 6,5 CM
PC55 PC65

Ø 10 CM Ø 12 CM
PC100 PC120

TAGLIA CROISSANT - CROISSANT CUTTERS

Rulli taglia croissant triangolari in acciaio inox con manico ergonomico in plastica.
Triangular stainless steel croissant cutting rollers with ergonomic plastic handle.



180x200 mm
RDC180X200
total size: 660 mm



misura di taglio **97x210 mm**
RSC97X210
total size: 460 mm

misura di taglio **180x140 mm**
RSC180X140
total size: 400 mm

misura di taglio **180x200 mm**
RSC180X200
total size: 450 mm

misura di taglio **96x153 mm**
RSC96X153
total size: 410 mm

misura di taglio **70x100 mm**
RSC70X100
total size: 360 mm

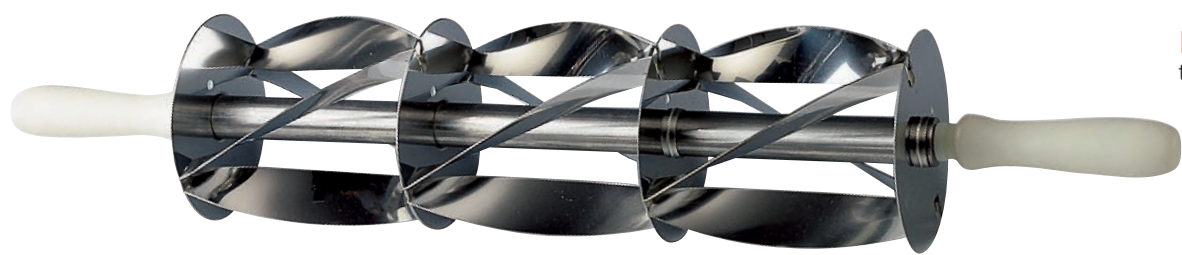

misura di taglio **180x200 mm**
RTC180X200
total size: 860 mm



La misura del taglio è riferita al triangolo di pasta.
The measure of the cut refers to the triangle of dough.

RULLI - ROLLING PINS

Rulli di legno
Wooden rolling pins



50 CM
RL 1
Ø 7CM

50 CM
RL 2
Ø 8CM

60 CM
RL 3
Ø 7CM

60 CM
RL 4
Ø 8CM

Rulli di legno girevoli
Revolving wooden rolling pins



30 CM
RLS30
Ø 8CM

35 CM
RLS35
Ø 8CM

40 CM
RLS40
Ø 8CM

45 CM
RLS45
Ø 8CM

50 CM
RLS50
Ø 8CM

60 CM
RLS60
Ø 8CM

Rulli in polietilene
Polyethylene rolling pins



30 CM
RLS50PE
Ø 7cm

40 CM
RLS60PE
Ø 7cm

50 CM
RLS70PE
Ø 7cm

Rulli in polietilene ideali per pasta di zucchero e cioccolato
Polyethylene rolling pins for sugar paste and chocolate

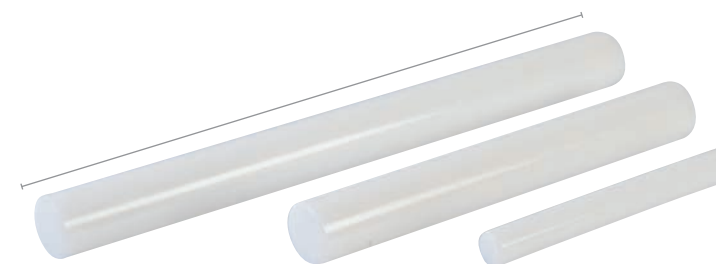

23 CM
40-W021
Ø 2,5cm

35 CM
40-W154
Ø 4,5cm

50 CM
40-W022
Ø 4,5cm

QUICK DISKS

Utilizzate per ottimizzare produzione, le dime forate sono ideali per produrre perfetti dischi di pan di spagna, meringhe ed altri impasti, senza sprechi ed in poco tempo. Realizzate in plastica alimentare, resistente e lavabile in lavastoviglie, in diversi diametri.

Used to optimise production, the perforated frames are ideal for producing perfect sponge cake discs, meringues and other doughs, without waste and in a short time. Made of food-grade plastic, resistant and dishwasher-safe, in different diameters.

Spessore 8 mm - 8 mm thick



Ø 13,5 CM
50DF138
Prod 8 pcs

Ø 17,5 CM
50DF178
Prod 6 pcs

Ø 15,5 CM
50DF158
Prod 6 pcs

Ø 19,5 CM
50DF198
Prod 4 pcs

RAPLETTE

Raplette in plastica - Plastic spatulas

Raplette in plastica, consentono di stendere e livellare in modo veloce, preciso ed uniforme vari impasti. Perfette per lo spostamento di cremi sulle chitarre.

Plastic raplette, allow you to spread and level various mixtures quickly, precisely and evenly. Perfect for transferring cremi on guitars.



30 CM
50SPB30
x cod: 50TLMINI



43 CM
50SPB43
x cod: 50TLSPECIAL



42 CM
CSMSPB40
x cod: CSM040



62 CM
CSMSPB60
x cod: CSM060

RAPLETTE

Raplette regolabile che consente di stendere e livellare in modo veloce, preciso ed uniforme impasti morbidi e cioccolato (anche multi-strato). Realizzata in resistente acciaio inox, conferisce al prodotto le dimensioni desiderate. La larghezza massima di stesura è 40 cm, lo spessore è variabile da 0.1 a 1.8 cm.

Adjustable Raplette for fast, precise and uniform spreading and levelling of soft dough and chocolate (also multi-layer). Made of resistant stainless steel, it gives the product the desired dimensions. The maximum spreading width is 40 cm, the thickness is variable from 0.1 to 1.8 cm.



SPB SPECIAL
MISURA MASSIMA
MAXIMUM SIZE

40CM

Misura esterna
External Size: 50x18 h 6

LEVEL

LEVEL
BISCUIT & MORE

LEVEL

50LE001

max cap. 12 lt
dimensioni/size: 480x200 h200 mm
peso/weight: 4,3 kg
Larghezza apertura/slot width: 380 mm
Acciaio inox/stainless steel
Made in Italy



STRATIFICAZIONE PERFETTA CON LEVEL

Stendi impasto su ruote maneggevole e pratico che permette di creare rapidamente strati precisi ed uniformi, anche negli spessori più sottili. Facilita e velocizza la stesura uniforme di biscuit, pan di spagna, cioccolato e prodotti simili, scorrendo su diverse superfici, come carta forno o tappeti in silicone.

Level è progettato per razionalizzare la produzione: velocizza i tempi, semplifica i passaggi e riduce i costi.

PERFECT LAYERING WITH LEVEL

Handy and practical wheel-mounted dough spreader that allows you to quickly create precise and regular layers, even in the thinnest thicknesses. It facilitates and speeds up the uniform spreading of biscuit, sponge cakes, chocolate and similar products, sliding on different surfaces, such as baking paper and silicone mats. Level is designed to rationalise production: it speeds up times, simplifies steps and reduces costs.

CANNOLI MOULDS

Stampi in acciaio per la produzione di cannoli.
Stainless steel moulds to make cannoli.

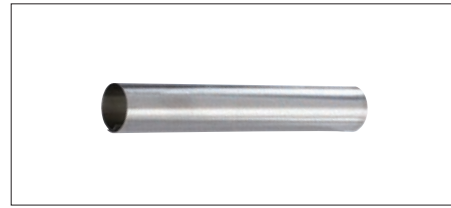

22x140 mm
50CI22X14
10 pcs

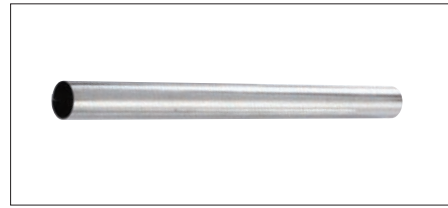

16x200 mm
50CI16X20
12 pcs

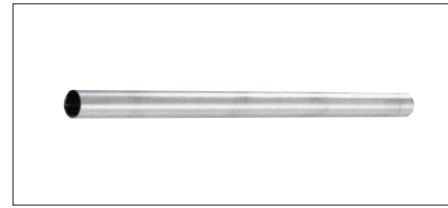

12x200 mm
50CI12X20
12 pcs

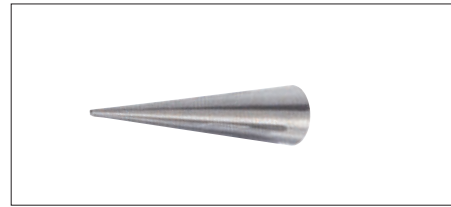

Ø30x120 mm
50CO30X12
12 pcs



Ø35x140 mm
50CO35X14
12 pcs

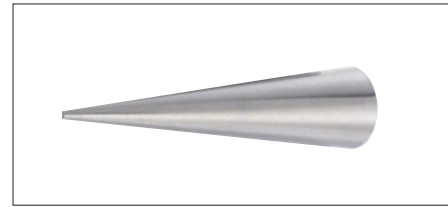

Ø40x160 mm
50CO40X16
12 pcs



Ø30x120 mm
CANNOLO
10 pcs

Stampi in plastica speciale per la produzione di cannoli.
Special plastic mould to make cannoli.



SEGNAPORZIONI - CAKE MARKERS

Porzionatori per torte utilizzabili in entrambi i lati.
Double faced cake portion markers.



Segnaporzioni Ø 25 cm in plastica per torte
Plastic cake markers Ø 25 cm

8-12 portions **12-16** portions **14-16** portions
PPT 8/12 **PPT 12/16** **PPT 14/16**

12-18 portions **14-18** portions **12** portions
PPT 12/18 **PPT 14/18** **PPT 12**



Segnaporzioni Ø 33 cm in acciaio per torte
St. Steel Cake markers Ø 33 cm

8 portions **10** portions **12** portions
PPT8X **PPT10X** **PPT12X**

14 portions **16** portions **18** portions
PPT14X **PPT16X** **PPT18X**



Griglia Tagliapasta per Crostate
Cutter for Tarts

Griglia per il taglio regolare della pasta in modo rapido e semplice.
Grid for regular cutting of dough in a quick and easy way.

Ø30 cm
DECOR 30

LIRA - CAKE SLICER



Lira per pan di spagna
Sponge cake slicer

CS3
460 mm
3 lame altezza variabile: da 10 a 90 mm.
3 variable height blades: from 10 until 90 mm.

CSL
lama di ricambio - spare blade

MICROPAPER

Let your creations breathe



LA PRIMA CARTA FORNO MICROFORATA THE FIRST MICRO-PERFORATED BAKING PAPER



sviluppata da un'idea di
developed from an idea of



Qualità superiore in minor tempo

Grazie alla presenza della microforatura, durante la cottura il vapore acqueo fuoriesce più velocemente. Questo garantisce un miglior passaggio dell'aria, che raffredda anche i prodotti più velocemente rispetto alla carta forno tradizionale.

Superior quality in less time

Thanks to the micro-perforation, steam escapes faster during baking. This ensures a better airflow, which also cools the products faster than with conventional baking paper.

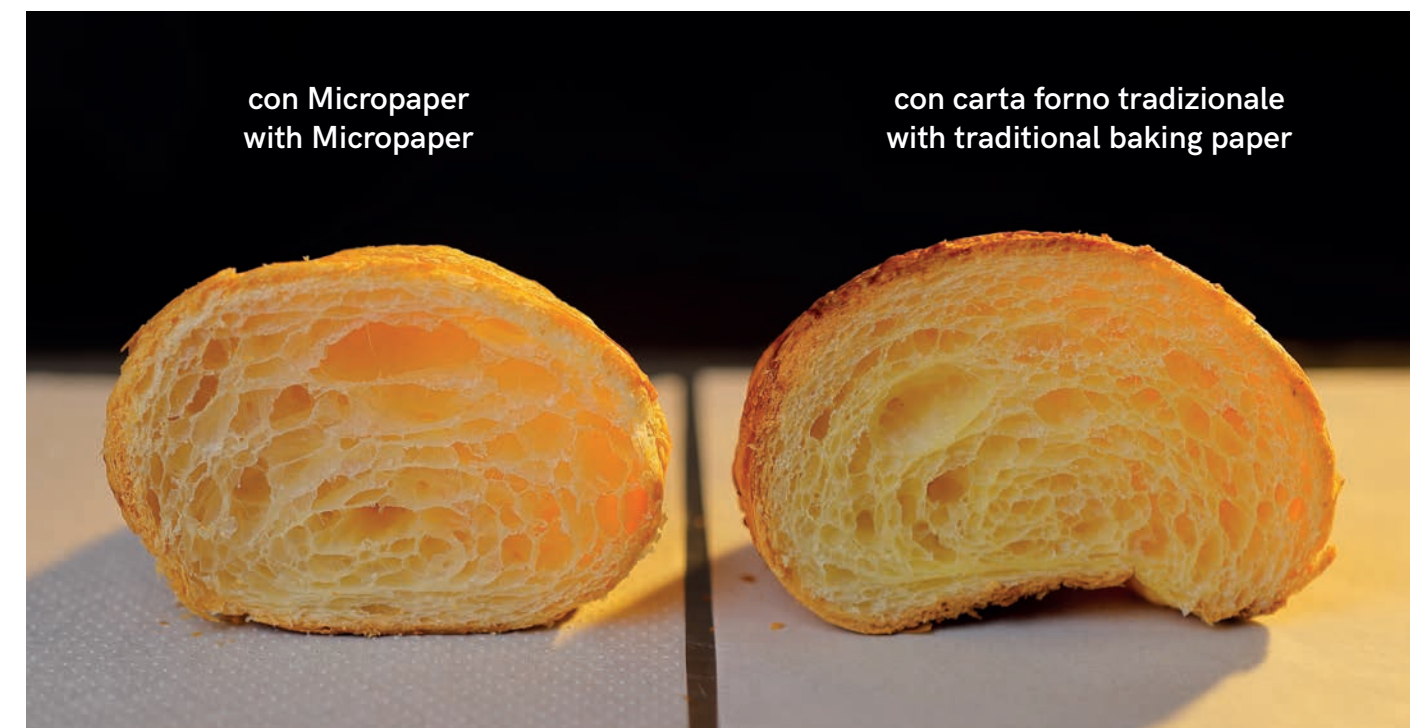

con Micropaper
with Micropaper

con carta forno tradizionale
with traditional baking paper



MICROPAPER

Carta forno microforata - Micro-perforated baking paper
59,2x39,2 CM
51MP6040
pack 200 fogli/sheets

**RISPARMIO DI
TEMPO & ENERGIA**

**ENERGY
& TIME SAVING**

circa
approx **8-10%**

1. MIGLIORE COTTURA
BETTER BAKING
2. RAFFREDDAMENTO PIÙ VELOCE
FASTER CHILLING
3. FLUSSO D'ARIA UNIFORME
UNIFORM AIRFLOW
4. RISPARMIO DI ENERGIA
ENERGY SAVING
5. COTTURA PIÙ RAPIDA
FASTER BAKING

IDEALE PER LA COTTURA DI

bigné • pasta frolla • biscotti • pasta sfoglia • paste lievitate • paste lievitate sfogliate • pasta brisée •
pane • pizza • focaccia • fonsage tart • cottura crumble e streusel

IDEAL FOR BAKING

cream puff • shortcrust pastry • biscuits • puff pastry • leavened doughs • leavened puff pastries •
brisée pastry • bread • pizza • focaccia bread • fonsage tart • crumble and streusel baking



CARTA FORNO TRADIZIONALE TRADITIONAL BAKING PAPER

Carta da Forno Professionale antiaderente e resistente alle alte temperature - Bisiliconata. Adatta per forno tradizionale e microonde - Multiuso.

Professional Baking Paper non-stick and high temperatures resistant - silicone on both sides. Suitable for traditional and microwave oven - Multiuse.

60x40 CM
51CF6040
500 fogli - sheets



SET TAGLIA PASTA - CUTTERS KIT

Set tagliapasta in acciaio inox proposti in kit multi misura.
Stainless steel cutters set offered in multi size kits.



CUT5L7
7 pcs
65 - 57 - 50 - 45 - 40
35 - 27 mm



CUT6L7
7 pcs
90x60 - 80x50 - 70x45
- 60x40 - 50x30 - 40x25
30x20 mm



CUT22L7
7 pcs
65x50 - 60x45 - 55x40
- 50x35 47x32 - 43x28
37x25 mm



CUT3L7
7 pcs
75 - 67 - 63 - 57 - 52
47 - 42 mm



CUT28L7
7 pcs
100x50 - 90x45 - 85x43
75x40 - 70x35 - 60x30
55x25 mm



CUT8L7
7 pcs
90x60 - 80x50 - 70x45
65x40 - 55x33 - 45x25
35x20 mm



CUT15L7
7 pcs
86x45 - 76x38 - 68x33
61x30 55x25 - 49x21
42x17 mm



CUT16L7
7 pcs
80 - 75 - 67 - 60 - 50
40 - 33 mm



CUT26L7
7 pcs
90 - 80 - 70 - 55 - 40
35 - 30 mm



CUT18L7
7 pcs
90x65 - 80x60 - 70x50
55x40 45x30 - 33x23
25x18 mm

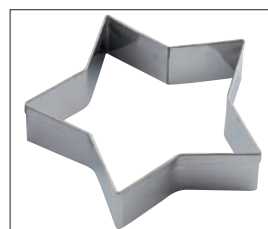

CUT31L7
7 pcs
90 - 80 - 70 - 60 - 50
40 - 30 mm

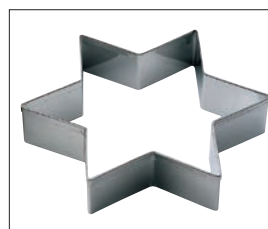

CUT10L9
9 pcs
37 - 51 - 66 - 82 - 96
110 - 125 - 137 - 150 mm

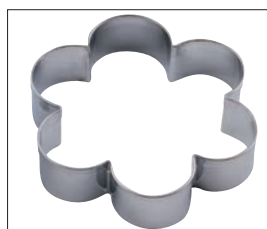

CUT12L7
7 pcs
90 - 80 - 65 - 53 - 42
55 - 30 mm



CUT20L7
7 pcs
90 - 75 - 70 - 55 - 45
40 - 25 mm

OVALI - OVAL



LISCI - SMOOTH
CUT2L7 - 7 pcs
85x70-75x65-65x55-55x45 45x35-
35x25-23x18 mm
CUT2L9 - 9 pcs
27x34-33x46-42x57-51x68-62x78-
71x87-82x97-92x107-102x117 mm

TONDI - ROUND



LISCI - SMOOTH
CUT1L7 - 7 pcs
30-40-50-60-70-80-90 mm
CUT1L9 - 9 pcs
30-40-50-60-70-80-90-100-110 mm
CUT1L12 - 12 pcs
30-40-50-60-70-80-90-100-110-
120-130-140 mm
CUT1L16 - 16 pcs
20-30-40-50-60-70-75-80-85-
90-95-100-110-120-125-140 mm

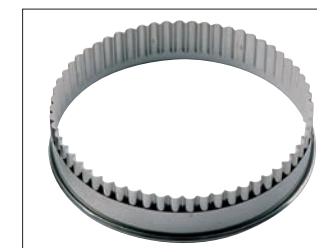

ONDULATI - WAVY
CUT1F9 - 9 pcs
30-40-50-60-70-80-90-100-110 mm
CUT1F12 - 12 pcs
30-40-50-60-70-80-90-100-110-
120-130-140 mm

CUORI - HEART



LISCI - SMOOTH
CUT7L7 - 7 pcs
35-40-45-55-65-75-85 mm
CUT7L9 - 9 pcs
36-43-52-60-70-80-90-100-110
mm
CUT7L12 - 12 pcs
36-43-52-60-70-80-90-100-110-
120-130-140 mm



ONDULATI - WAVY
CUT7F9 - 9 pcs
60-70-80-90-100-110-120-130-140 mm

Taglia pasta in acciaio inox, con manico. - Stainless steel cutter, with handle.



LISCI - SMOOTH
CUT1LM12
Ø 120 x h20 mm
CUT1LM14
Ø 140 x h20 mm



ONDULATI - WAVY
CUT1FM12
Ø 120 x h20 mm
CUT1FM14
Ø 140 x h20 mm

MINI TAGLIA PASTA - MINI CUTTERS



Set tagliapasta - Praline cutters set
PRA 9
Tagliapasta inox per praline di marzapane
St. Steel marzipan pralines cutters set
h 50 mm



35x20 30x19 40x23 25x25 35x35 35x25 40x27 40x23 Ø28

GRIGLIE TAGLIAPASTA PLASTIC CUTTER GRIDS

Placca in plastica per la produzione di soggetti tematici di pasta frolla, sfoglia ed altri impasti. Ideale per la preparazione di biscotteria dolce e salata.
Plastic grid for cutting shortcrust pastry, puff pastry and other doughs. Ideal for preparing sweet and savory biscuits.
Misure-Size: 60x40cm

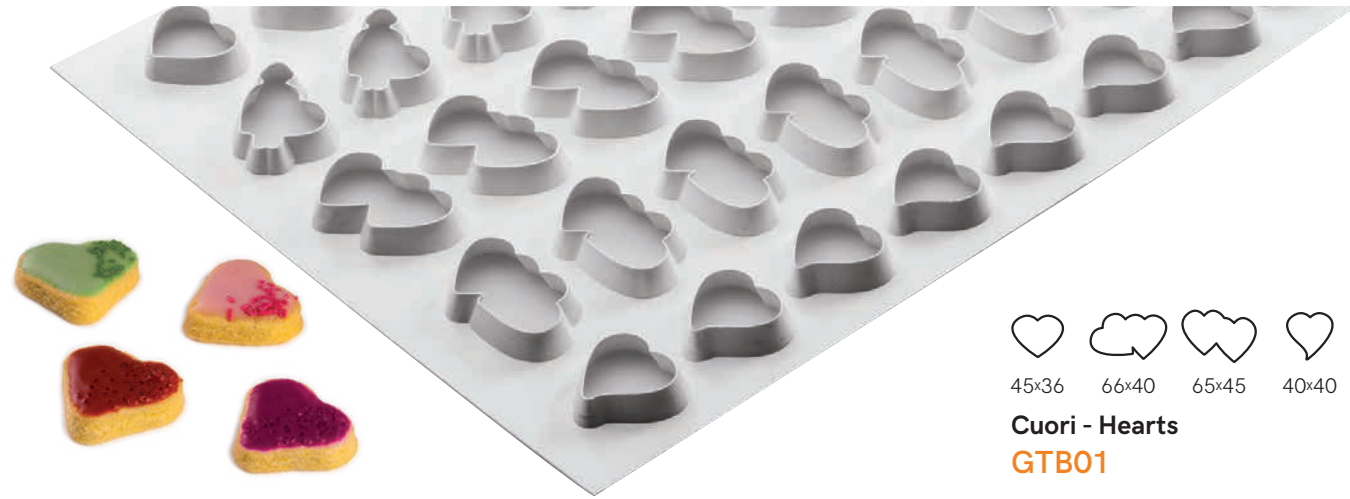

Cuori - Hearts
GTB01



Halloween
GTB02

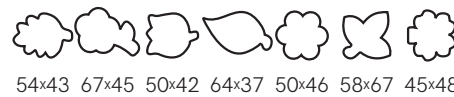

Fiori Foglie - Flowers Leaves
GTB05



Croce Festonata - Wavy Cross
GTB18

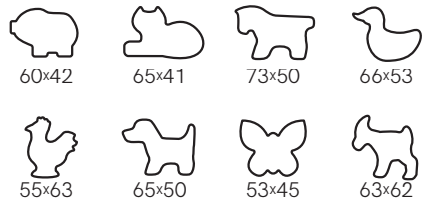

Anim. domestici - Pets
GTB06

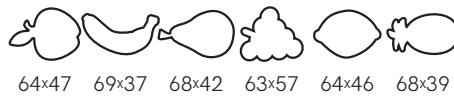

Frutta - Fruit
GTB08

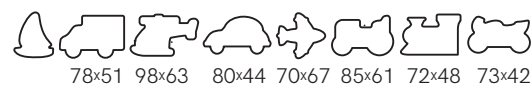

Trasporti - Transport
GTB10



42x38 mm - 35pcs

Stella - Star
GTB17



Ø39 mm - 40pcs

Tondo festonato - Wavy round
GTB15



39x36 mm - 40pcs

Cuore - Heart
GTB19



Dolce San Martino

SMA320
stampo - mould 380x400 mm
soggetto - subject 300x340 mm

SMA260
stampo - mould 295x330 mm
soggetto - subject 245x270 mm

SMA180
stampo - mould 230x260 mm
soggetto - subject 180x200 mm

SMA110
stampo - mould 170x190 mm
soggetto - subject 110x125 mm

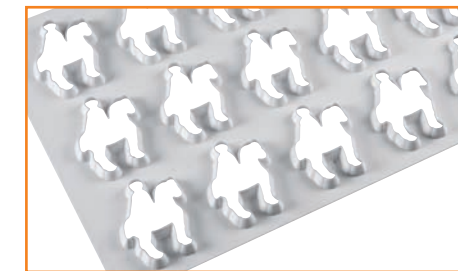

Biscotti San Martino

GTB13
stampo - mould 578x390 mm
soggetto - subject 77x100 mm
15 pcs

FLACONI - BOTTLES



Flacone per bagna e sciroppo
Syrup soaker bottle

50FL00 cap. 1 lt
100x56 h275 mm

50FL00C cap. 1 lt
con tappo e copritappo/with cap
100x56 h275 mm



Flacone per bagna e sciroppo
Syrup soaker bottle

FLACONE cap. 1 lt
70x70 h270 mm



Porta Flacone - Bottles holder
PORTFLACONE

250x110 h 80 mm
Cap. 3 x FLACONE
Flaconi non inclusi/Bottles not included



Flacone per bagna e sciroppo
Syrup soaker bottle

FLAN1 cap. 1 lt
Ø85 h 250 mm
50FLAN2 cap. 0,5 lt



Flacone nebulizzatore
Spraying bottle

FLACONE2 cap. 1 lt
70x70 h300 mm
50FLAN2T cap. 0,5 lt



Flacone dosatore - tappo con beccuccio
Dosage bottle - cap and nozzle

BO1000N cap. 1 lt
Ø79 h283 mm
BO500N cap. 0,5 lt
Ø60 h253 mm
BO250N cap. 0,25 lt
Ø50 h194 mm
BO100N cap. 0,1 lt
Ø40 h138 mm

DIME - TEMPLATES

Dime di taglio in plastica trasparente per il taglio in strisce regolari di pastafrolla, cioccolato e biscuit.
Transparent plastic grids for cutting regular strips of shortcrust pastry, chocolate and biscuit.

50GD0015

Griglia speciale per tagli da 1,5 cm.
Special grid to cut 1,5 cm.

50GD0018

Griglia speciale per tagli da 1,8 cm.
Special grid to cut 1,8 cm.

50GD0022

Griglia speciale per tagli da 2,2 cm.
Special grid to cut 2,2 cm.

50GD0027

Griglia speciale per tagli da 2,7 cm.
Special grid to cut 2,7 cm.

50GD0037

Griglia speciale per tagli da 3,7 cm.
Special grid to cut 3,7 cm.

50GD2040

Griglia speciale per tagli da 2 e 4 cm.
Special grid to cut 2 and 4 cm.

50GD3060

Griglia speciale per tagli da 3 e 6 cm.
Special grid to cut 3 and 6 cm.

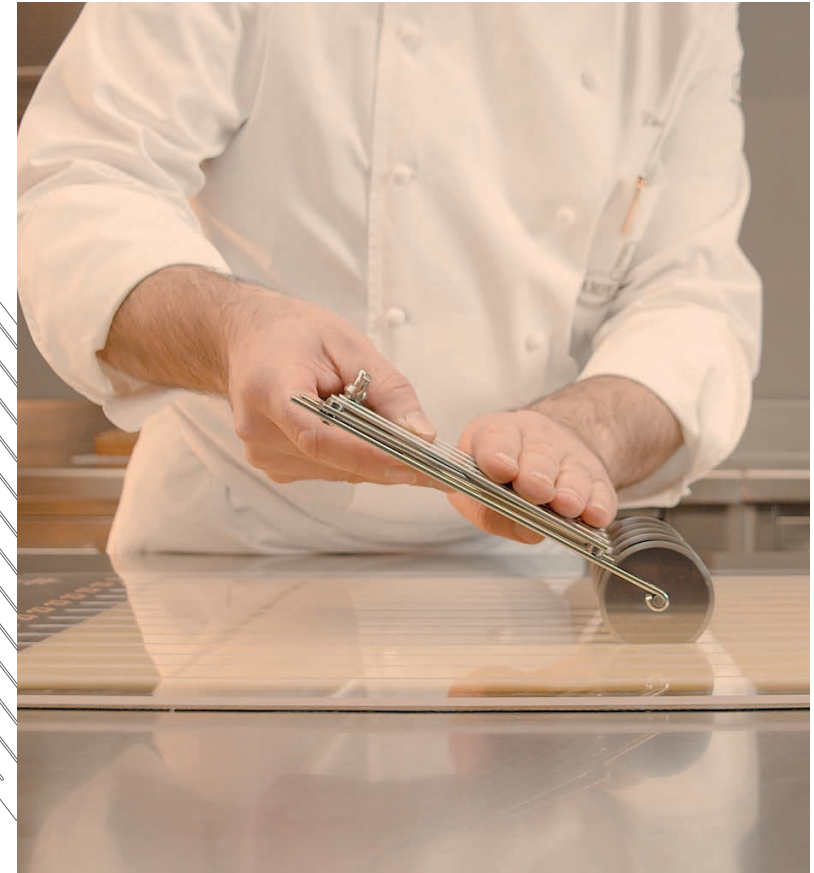
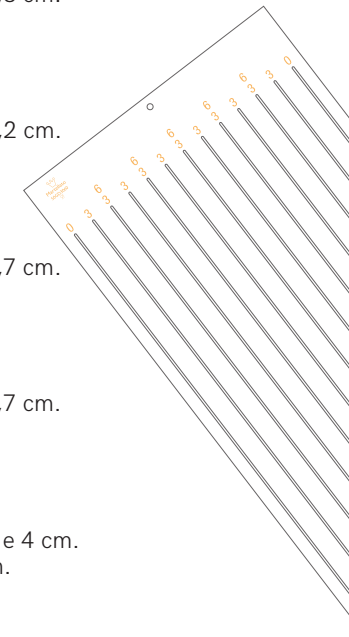

Righelli trasparenti in plastica - Plastic transparent rulers

RIGA64

5 Divisioni da 12 cm e 7 divisioni da 8 cm.
Five 12 cm divisions and seven 8cm divisions.

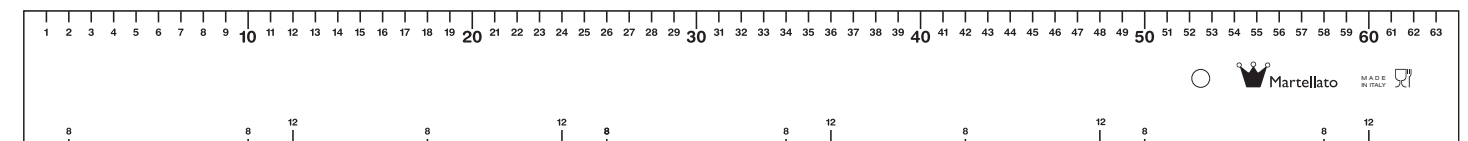

TAGLIERI - CUTTING BOARD

Taglieri

Cutting board
Piano di lavoro in plastica
Plastic worktop

TAG5
50x30 h3 cm

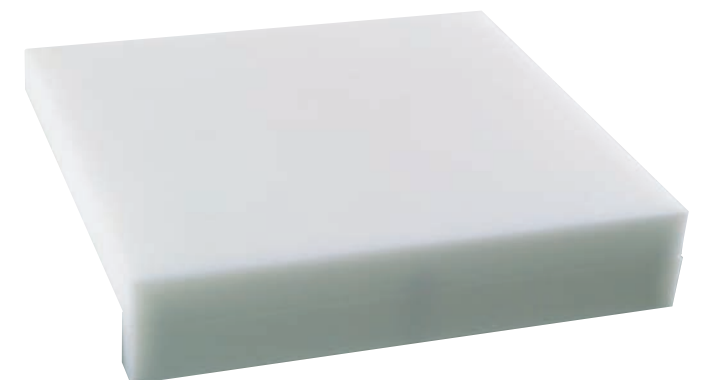

TEGLIE FORNO - BAKING TRAYS

Servizio teflonatura su richiesta
On demand tefloning service

TEGLIE ALLUMINIO ALUMINIUM TRAYS

53TA60404

2cm - 60x40 cm

Teglia in **alluminio** con **4 bordi**, spessore 1,5 mm
Aluminium baking tray with **4 edges**, 1,5 mm thick

53TA60402

2cm - 60x40 cm

Teglia in **alluminio** con **2 bordi**, spessore 1,5 mm
Aluminium baking tray with **2 edges**, 1,5 mm thick

TEGLIE FORATE ALLUMINIO PERFORATED ALUMINIUM TRAYS

53TAF60404

2cm - 60x40 cm

Teglia forata in **alluminio** con **4 bordi**, spessore 1,5 mm
Flat **perforated aluminium** baking tray with **4 edges**, 1,5 mm thick

53TAF40304

2cm - 40x30 cm

Teglia forata in **alluminio** con **4 bordi**, spessore 1,5 mm
Flat **perforated aluminium** baking tray with **4 edges**, 1,5 mm thick

53TAF40302

2cm - 40x30 cm

Teglia forata in **alluminio** con **2 bordi**, spessore 1,5 mm
Flat **perforated aluminium** baking tray with **4 edges**, 1,5 mm thick

TEGLIE ALLUMINATE ALUMINIZED TRAYS

53TL60404

2cm - 60x40 cm

Teglia **alluminata** con **4 bordi**, spessore 0,8 mm
Made of aluminized sheet with **4 edges**, 0,8 mm thick

53TL60402

2cm - 60x40 cm

Teglia **alluminata** con **2 bordi**, spessore 0,8 mm
Made of aluminized sheet with **2 edges**, 0,8 mm thick

TAPPETI COTTURA - BAKING MATS

Tappeti antiaderenti in silicone per cottura e surgelazione di qualsiasi prodotto alimentare.

Non-stick silicon mats for baking and freezing every kind of food.

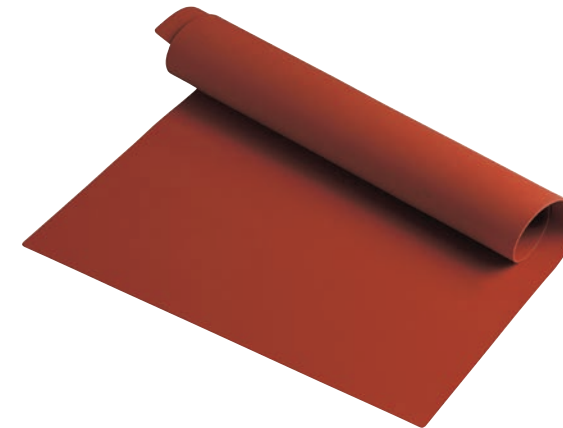

39,5x59,5 CM

SILICOPAT1/R

30X40 CM

SILICOPAT7/R

27x42 CM

SILICOPAT5/R

31x51 CM

SILICOPAT2/R

36x43 CM

SILICOPAT6/R

Tappeti antiaderenti in silicone con fibra di vetro per cottura e surgelazione di qualsiasi prodotto alimentare.

Ideali per la lavorazione dello zucchero.

Non-stick silicon mats with glass fibres for baking and freezing every kind of food. **Ideal to work with sugar.**



59x39 CM

SILICOPAT1/B

31x51 CM

SILICOPAT2/B

62X42 CM

SILICOPAT3/B

79x59 CM

SILICOPAT4/B

Pack
5 pcs



Tappetino antiaderente in PTFE antiaderente.

Non stick PTFE mat.

Pack 5 pcs.

59X39 CM

TEFLONPAT5

Tappeti silicone microforato con fibra di vetro.

Silicone mats perforated with glass fibres.



38,5x58,5 CM

MICROMAT60

38,5x28,5 CM

MICROMAT30

CARAFFE - CARAFES



**Caraffa graduata MAXI in plastica di alta qualità.
MAXI graduated carafe made of high quality plastic.**

Impugnatura chiusa rinforzata, plastica translucida,
scala graduata in rilievo.
Resistente agli urti anche alle basse temperature.

Reinforced closed handle, translucent plastic,
graduated scale in relief.
Impact resistant even at low temperatures.



**Caraffa con coperchio
Carafe with lid**
CFTRA6C - 6000 ML
coperchio paraschizzi apribile
openable splash protection lid

**Caraffa
Carafe**
CFTRA6 - 6000 ML

**Caraffe graduate plastica trasparente
Transparent plastic measuring cups**

Caraffa graduata in plastica impugnatura aperta.
Plastica trasparente - impilabili.

Graduated plastic carafe with open handle.
Transparent plastic - stackable.



500 ml **1000 ml** **2000 ml** **3000 ml**
CFTRA1 **CFTRA2** **CFTRA3** **CFTRA4**

SESSOLE - FLOUR SCOOPS

Pratiche sessole in plastica con base piatta, per conferire stabilità anche se appoggiate, adatte anche a liquidi.
Practical plastic bailers with a flat base, in order to provide stability even if laid, suitable for liquids as well.



125 ml **250 ml** **512 ml**
SES 100 **SES 250** **SES 500**
Size: 185x65 mm Size: 250x90 mm Size: 310x117 mm
Spoon: 110x65 mm Spoon: 150x90 mm Spoon: 190x117 mm

857 ml **1520 ml**
SES 800 **SES 1500**
Size: 345x145 mm Size: 400x175 mm
Spoon: 230x145 mm Spoon: 275x175 mm

CIOTOLE - BOWLS

**Ciotola in policarbonato trasparente
Transparent polycarbonate bowls**



0,4 L **1 L** **2,5 L**
52BO13PC **52BO17PC** **52BO23PC**
Ø 13 cm Ø 17 cm Ø 23 cm

4 L **8 L** **10 L**
52BO28PC **52BO32PC** **52BO38PC**
Ø 28 cm Ø 32 cm Ø 38 cm

**Ciotola in polipropilene bianco
White polypropylene bowls**



0,4 L **1 L** **2,5 L**
52BO13PP **52BO17PP** **52BO23PP**
Ø 13 cm Ø 17 cm Ø 23 cm

4 L **8 L** **10 L**
52BO28PP **52BO32PP** **52BO38PP**
Ø 28 cm Ø 32 cm Ø 38 cm

STAMPI PANE - BREAD MOULDS

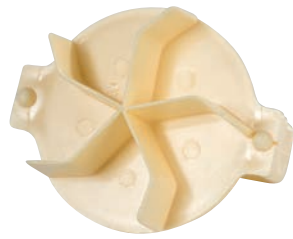

Stampo per pane kaiser
Kaiser bread mould
STPTA 6
Ø8cm



Stampo per pane kaiser
Kaiser bread mould
STPTA 7
Ø8cm

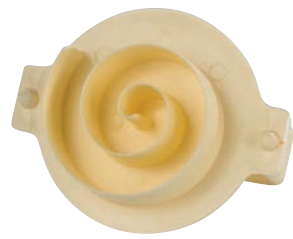

Stampo per pane girella
Girella bread mould
STPTA 8
Ø8cm



Stampo per pane zucca
Pumpkin bread mould
STPZ
Ø8cm



Stampo pane tartaruga quadrato
Square turtle bread mould
STPTA 1
14x10cm



Stampo pane tartaruga esagonale
Hexagonal turtle bread mould
STPTA 2
14x11cm



Stampo pane margherita
Marguerite bread mould
STPTA 5
Ø12,5cm



Stampo pane sole
Sun bread mould
STPTA 3
Ø12,5cm



Marcatore girevole per pane kaiser
Kaiser bread revolving marker
STPK
L 200 - Ø6cm

TELO COPRI IMPASTO DOUGH PROOFING SHEET

Ideale per proteggere gli impasti durante la lievitazione conservando il giusto livello di umidità, riparando da agenti esterni ed aria. Il telo è utile per coprire i prodotti da forno durante il raffreddamento in modo da trattenere gli aromi che si sprigionano subito dopo la cottura. Realizzato in **trasparente polietilene alimentare**, destinato ad uso professionale, garantisce la massima igiene, praticità d'uso e durata nel tempo.

Ideal for protecting doughs during leavening and maintaining the right level of humidity, protecting from external agents and air. The sheet is also useful for covering baked goods during cooling in order to retain the aromas that are released immediately after cooking. Made of **transparent food-grade polyethylene**, for professional use, it guarantees maximum hygiene, practical use and durability.

55TP6080

60X80CM

PACK 50 pcs - 70 My



CESTINI PANE - BREAD BASKET

Cestini per lievitazione
Leavening bread baskets



Cap. gr	Size cm	Code
1500	Ø25	BASKET 205
1000	Ø21,5	BASKET 206
500	Ø18	BASKET 207
250	Ø13	BASKET 208

Cap. gr	Size cm	Code
1500	40x14	BASKET 105
1000	35x13	BASKET 106
500	27x12	BASKET 107

Cap. gr	Size cm	Code
1000	29x18	BASKET 102
500	22x14	BASKET 103
750	24x14	BASKET 108

TAGLIERINI - BREAD CUTTERS



Lama ondulata - Fluted blade
INOX
CUTTER 8
9cm



Coltellino doppia lama ondulata
Cutter with double fluted blade
CUTTER 12
8cm



Lama ondulata - Fluted blade
INOX
50COL51
8cm



Lama liscia - Plain blade
INOX
CUTTER 7
9cm



Lama liscia - Plain blade
INOX
50COL50
7cm



Lama segna pane
Marking bread blade
CUTTER 15



Coltellino plastica lama girevole
Plastic cutter with rotating blade
CUTTER 4



Coltellino plastica lama fissa
Plastic cutter with fixed blade
CUTTER 1



Cutter baguette con manico plastica
Plastic cutter for bread
CUTTER13
kit 2 pcs

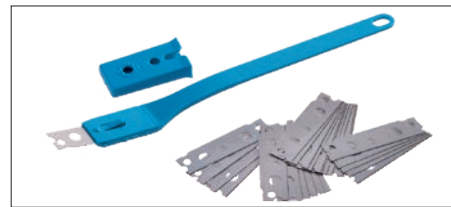

Coltellino plastica lama fissa
Plastic cutter with fixed blade
CUTTER5
1 Cutter + 25 lame/blades

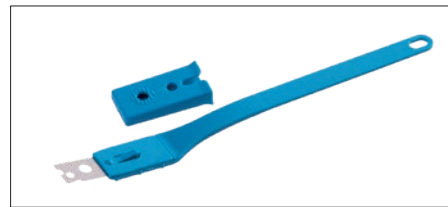

Coltellino plastica lama fissa
Plastic cutter with fixed blade
CUTTER5/A
1 Cutter

SPAZZOLE - BRUSHES



SPZ SE
400x40 mm
Temp. MAX 90° C

con setole naturali.
with natural bristles.



SPZ PL1
210x65 mm
Temp. MAX 130° C

con setole in poliestere.
with polyester bristles.



Spazzola inox - Inox brush
SPZ INOX
145x55 mm

con setole in acciaio inox.
with stainless steel bristles.

CAPPELLI IN CARTA - PAPER HATS



h 250 mm
CAP2B
10 pcs



h 200 mm
CAP 3
10 pcs Regolabile - Adjustable



280x h85mm
CAP 4
25 pcs



Manopole in pelle - Leather mitten

GL1
380x150 mm

Resistenti fino ad una temperatura di ca. 250°C
Realizzate in pelle morbida e rivestimento interno di gomma piuma.

Heat resistant up to a temperature of approx. 250 ° C
Made of soft leather and foam inner lining

CE marking: II CAT. EN 388:2016 EN 407:2004



Manopole in pelle polso lungo - Long leather mitten

GL2
450x150 mm

Resistenti fino ad una temperatura di ca. 250°C
Ideali per la protezione della mano e dell'avambraccio.
Realizzate in pelle morbida e rivestimento interno di cotone.

Heat resistant up to a temperature of approx. 250°C
Ideal for arm and hand protection.
Made of soft leather and inner lining of cotton.

CE marking: II CAT. EN 388:2016 EN 407:2004



Guanti in pelle a tre dita - Three-fingers leather oven gloves

GL3
340x140 mm

Resistenti fino ad una temperatura di ca. 250°C
Realizzati in pelle morbida e rivestimento interno di cotone.

Heat resistant up to a temperature of approx. 250 ° C
Made of soft leather and inner lining of cotton.

CE marking: II CAT. EN 388:2016 EN 407:2004



**Manopole in cotone
Short cotton mitten**

GL10
100% cotone - cotton - 27x15cm



**Manopole lunghe in cotone
Long cotton mitten**

GL11
100% cotone - cotton - 34x15cm



**Presine per forno in pelle
Oven leather pot holder**

GL25PRE
25x35cm
GL18PRE
18x25cm



SEG001N
70x40mm - 15 pcs



SEG002N
60X80mm - 25 pcs



SEG008N
60x90mm - 25 pcs

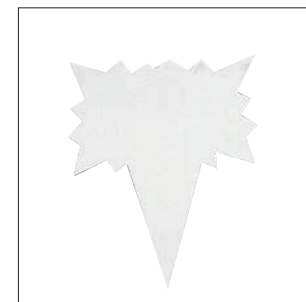

SEG015N
60x50mm - 50 pcs



SEG005N
55x80mm - 50 pcs



SEG006N
60X80mm - 40 pcs



SEG024N
55x92mm - 25 pcs

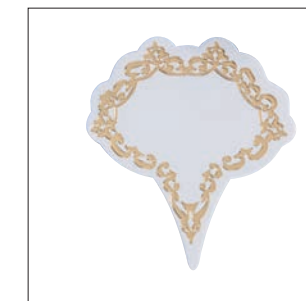

SEG004N
35x40mm - 30 pcs



SEG027N
65x62mm - 15 pcs

CAKE BOARD

TAVOLE MULTIFUNZIONE

per lo spostamento e stoccaggio di torte ed altri prodotti. Realizzate in materiale plastico di alta qualità e resistenza, non assorbono odori, né umidità.

MULTI-PURPOSE BOARDS

for moving and store cakes and other products. Made of a high quality and resistant plastic material, they absorb neither odor nor moisture.



SPESSORE THICKNESS
8
MM



Realizzati in materiale parzialmente proveniente da plastica riciclata.
Made of material partially from recycled plastic.

Disponibili in diverse misure e forme, per adattarsi alle molteplici esigenze. Disponibili anche con piedini a sfera Ø 25 mm. **Altre misure forme realizzabili su richiesta.**

Available in many sizes and shapes, suitable for different needs. Available with or without plastic feet Ø 25 mm. **Other shapes and sizes on request.**

Rotonda - Round

Misura Size cm	Piedini Feet	Codice Code
Ø 40	4	TAV D. 40 C/P
Ø 40	no	TAV D. 40 PIA
Ø 50	5	TAV D. 50 C/P
Ø 50	no	TAV D. 50 PIA
Ø 60	5	TAV D. 60 C/P
Ø 60	no	TAV D. 60 PIA
Ø 70	9	TAV D. 70 C/P
Ø 70	no	TAV D. 70 PIA
Ø 80	9	TAV D. 80 C/P
Ø 80	no	TAV D. 80 PIA
Ø 90	9	TAV D. 90 C/P
Ø 90	no	TAV D. 90 PIA
Ø 100	13	TAV D. 100 C/P
Ø 100	no	TAV D. 100 PIA

Rettangolare - Rectangular

Misura Size cm	Piedini Feet	Codice Code
40x60	5	TAV 40X60 C/P
59x39	no	TAV 59X39
40x60	no	TAV60X40
50x60	5	TAV 50X60 C/P
50x60	no	TAV 50X60 PIA
60x70	9	TAV 60X70 C/P
60x70	no	TAV 60X70 PIA
60x80	12	TAV 60X80 C/P
60x80	no	TAV 60X80 PIA

Quadrata - Square

Misura Size cm	Piedini Feet	Codice Code
50x50	4	TAV 50X50 C/P
50x50	no	TAV 50X50 PIA
60x60	5	TAV 60X60 C/P
60x60	no	TAV 60X60 PIA
70x70	9	TAV 70X70 C/P
70x70	no	TAV 70X70 PIA

piedino - plastic feet Ø 25 mm

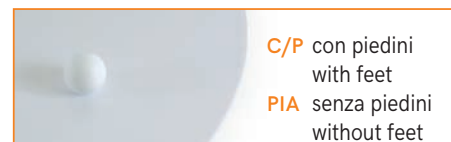

C/P con piedini
with feet
PIA senza piedini
without feet

SOTTOTORTA ROTONDI IN PLASTICA RIGIDA HARD PLASTIC ROUND CAKE BOARDS

SPESSORE THICKNESS
3
MM

Kit completo - Complete kit

SET DISK

kit 8 pcs (PST)

Ø 20 - Ø 22 - Ø 24 - Ø 26 - Ø 28 - Ø 30 - Ø 32 - Ø 34



Misure singole

Single size

kit 3 pcs (PST)

Size cm	Codice Code
Ø 20	50DI20
Ø 22	50DI22
Ø 24	50DI24
Ø 26	50DI26
Ø 28	50DI28
Ø 30	50DI30
Ø 32	50DI32
Ø 34	50DI34

SOTTOTORTA IN PLASTICA ALVEOLATA HONEYCOMB PLASTIC CAKE BOARDS

20 pcs

SPESSORE THICKNESS
2
MM



Rotondi - Round

Size cm	Codice Code	Size cm	Codice Code
Ø 16	50ST16	Ø 26	50ST26
Ø 18	50ST18	Ø 28	50ST28
Ø 20	50ST20	Ø 30	50ST30
Ø 22	50ST22	Ø 32	50ST32
Ø 24	50ST24	Ø 40	50ST40

Accessori per copertura carrelli Trolleys cover accessories



Copertura monouso per carrelli Disposable trolley cover

50CP01

GN 2/1 60x40 h 180 cm
roll 200 pcs - 20 micron

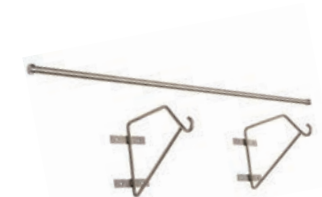

Staffa inox da muro porta rotolo Stainless steel wall bracket for roll holder

50ST01 - porta rotolo - roll holder 50CP01

DECORATION



SUGAR LAMP

Lampada per Zucchero

Ideata per la lavorazione dello zucchero.
 Realizzata in metallo verniciato e acciaio spazzolato.
 Regolazione del corpo lampada in altezza ed in inclinazione.
 Controllo della potenza su 2 livelli: 600- 1200W.
 Piano di lavoro: 625 x 450 mm - completa di cablaggio elettrico.

Designed for sugar processing.
 Made in varnished metal and brushed steel.
 Height and tilt adjustment of the lamp body.
 2-level power control: 600- 1200W.
 Work surface: 625 x 450 mm - complete with electric cable.

Lampada - Lamp
LAMP01

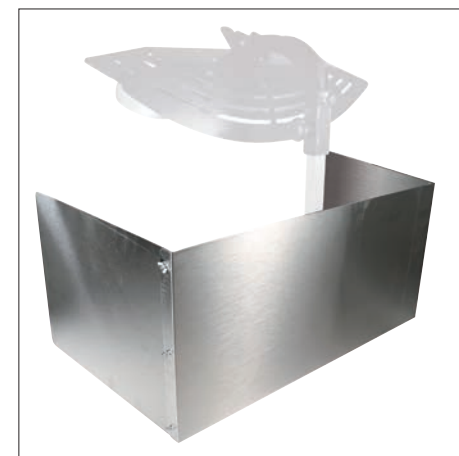
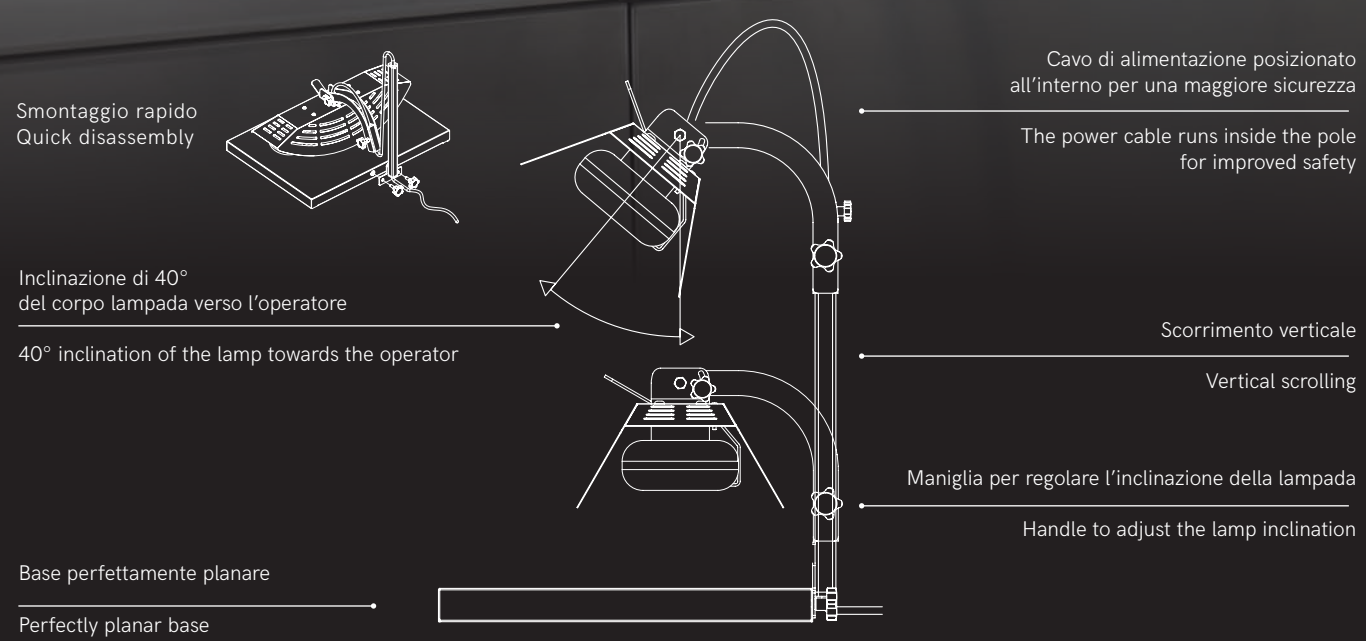

Paratia antivento acciaio inox
 Stainless steel shelter
LAMPLEX
 Dimensioni/dimensions 65x32 h 40 cm



Caramellometro
 Caramellometer
MTE - h 30cm
 da +80°C a +200°C
 from +80°C to +200°C

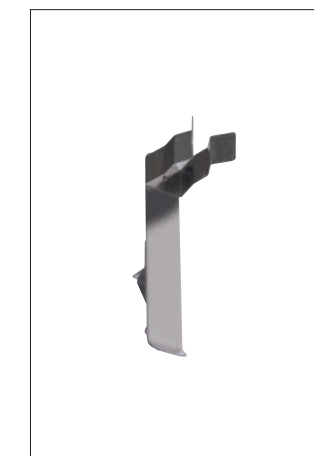

Supporto caramellometro
 Caramellometer holder
MRTE - h13,7cm



Guanti in lattice - Latex gloves
GL 7 - taglia/size 7 - 7,5
GL 8 - taglia/size 8 - 8,5
GL 9 - taglia/size 9 - 9,5



Pompetta - Sugar pump
POMP

CANNELLI - TORCH

Cannelli multifunzionali per pasticceria, gastronomia e cucina. Ideali per caramellare zucchero e meringhe, gratinare, scaldare e sciogliere. Fiamma regolabile, pulsante fiamma continua. Impugnatura antiscivolo, facilmente ricaricabile. Gas non incluso.

Multifunctional kitchen torches for pastry, gastronomy and cooking. Ideal for caramelising sugar and meringues, gratinating, heating and melting. Adjustable flame, continuous flame button. Non-slip grip, easily rechargeable. Gas not included.



CANNELLO PRO
 Dimensioni/dimensions 154x74x198 mm
 Temperature 1300°C / 2400°F
 Volume 140 ml butano/butane
 Autonomia gas serbatoio pieno/burning time full tank 60 min



CANNELLOBIG
 Cartuccia usa e getta, corpo in plastica
 Disposable cartridge torch, plastic body
 Ugello/nozzle 0,28 mm - Potenza/power 1.90 kW

CAKE DESIGN



Decoration

SUGAR MATS

Tappeti in silicone ideali per vestire il tuo dolce con un decoro in zucchero di grande effetto.
Silicone mats ideal to dress up your cake with an impressive sugar decoration. Misura - Size: 30x40cm



40-WD001 Decorations: 388x88mm

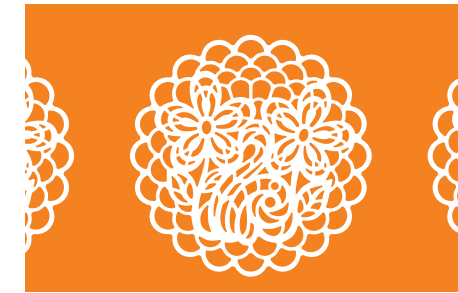

40-WD002 Decorations: Ø88mm

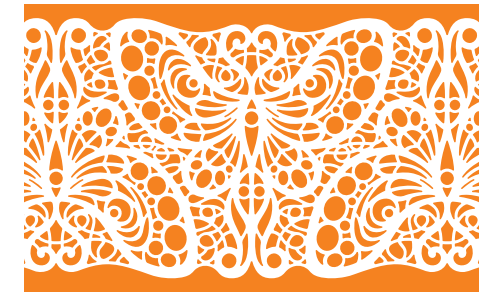

40-WD003 Decorations: 388x86mm



40-WD004 Decorations: Ø79mm



40-WD005 Decorations: 380x86mm



40-WD006 Decorations: 72x72mm

SUGAR DRESS

Preparato per la creazione di pizzi e decorazioni per torte, pasticcini e cupcake. **Sugar dress** è un sistema facile e veloce per ottenere un decoro raffinato e di grande effetto. È sufficiente aggiungere ai due preparati dell'acqua, mescolare bene il composto e spalmarlo con una spatola nell'apposito tappetino Martellato.

Prepared for the creation of lace and decorations for cakes, pastries and cupcakes. **Sugar dress** is an easy and quick system to obtain a refined and impressive decoration. Simply add water to the two preparations, mix the mixture well and spread it with a spatula in the special Martellato mat.



SUGAR DRESS

EFSD001

Bianca - White

Secchiello 500 gr - Bucket 500 gr
GLUTEN FREE



FIORI - FLOWERS



LILIUM 40-W049S
17x48mm - 24x70mm - 32x90mm - 39x110mm



40-W055
Controstampo - Formers
Ø 160 h60mm - Kit 4 pcs



POINSETTIA 40-W188S
17x32 - 29x52 - 31x62 - 37x60 mm



SURFINIA 40-W193S
66x60 - 38x52 mm



40-W193C
Controstampo - Formers
Ø 75 h50mm - Kit 4 pcs



IBISCUS 40-W051S
19x48mm - 27x70mm - 35x90mm - 44x110mm

40-W027
Controstampo - Formers
Ø 115 h55mm - Kit 4 pcs



DAHLIA 40-W206S
Ø90mm - Ø65 mm

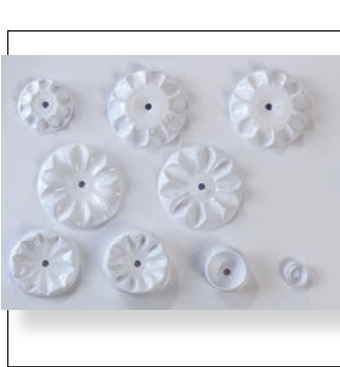

40-W206C
Controstampo - Formers
380x280mm - Kit 5 pcs

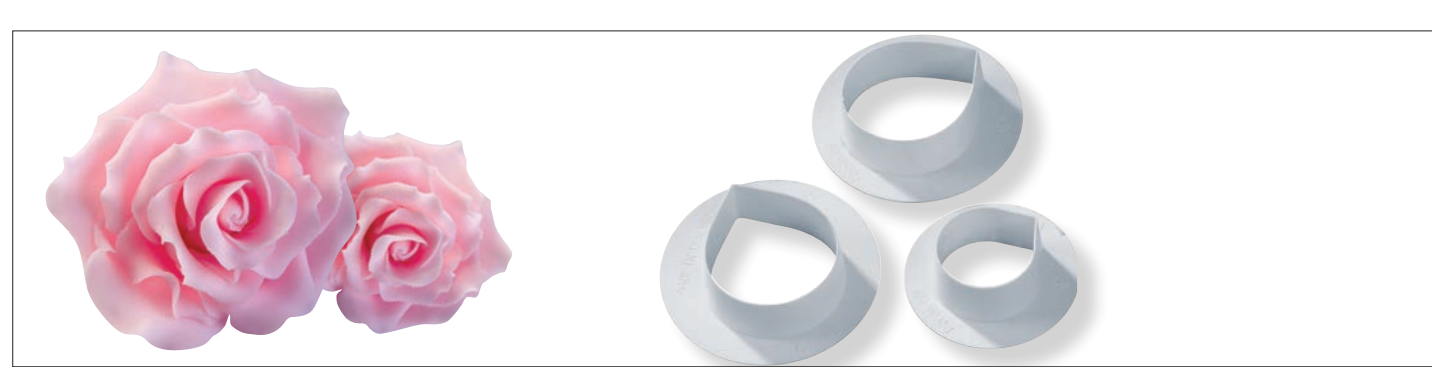

ROSE 40-W028
32x29mm - 39x34mm - 47x40mm



TULIP 40-W194S
27x46mm - 66x37mm



40-W194B
Supporto - Flower formers
Ø 100 h90mm - Kit 5 pcs



40-W194C
Controstampo - Formers
380x280mm - Kit 5 pcs



ORCHID 40-W030
72x72mm - 96x66mm
57x31mm

40-W053
Controstampo - Formers
Ø 132 h55mm

VENATORI - VEINERS

Stampo **venatore** in silicone e **cutter** in plastica per venare petali e foglie.
Veiner silicon mould and plastic **cutter** to veiner petals and leaves.

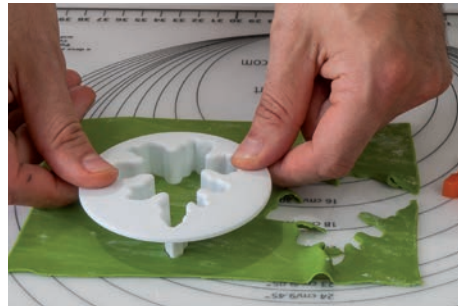
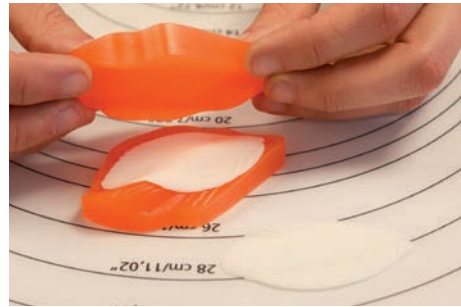

40-WF001 81x55mm

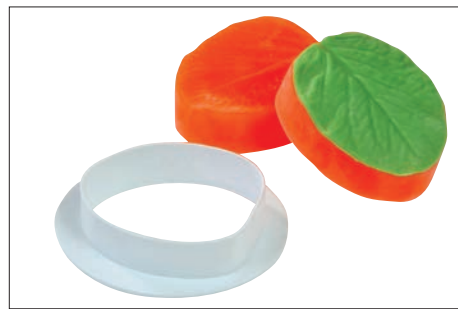

40-WF002 55x46mm



40-WF003 110x97mm



40-WF007 160x69mm



40-WF008 89x31mm



40-WF009 66x39mm

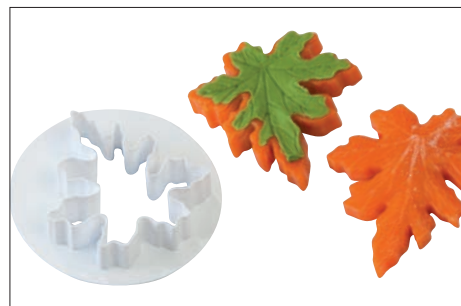

40-WF010 74x69mm



40-WF012 85x34mm
solo venatore - only veiner

Pantografino - Pantograph

40-WA001V

Il kit include:
 4 rotelline lisce - 4 coppie di rotelline ondulate
 2 distanziatori da 15 mm - 2 distanziatori da 10 mm
 4 distanziatori da 5 mm

The kit includes:
 4 smooth wheels and 4 couples of fluted wheels
 2 spacers 15 mm - 2 spacers 10 mm - 4 spacers 5 mm



CUTTER LETTERE E NUMERI LETTERS AND NUMBERS CUTTER

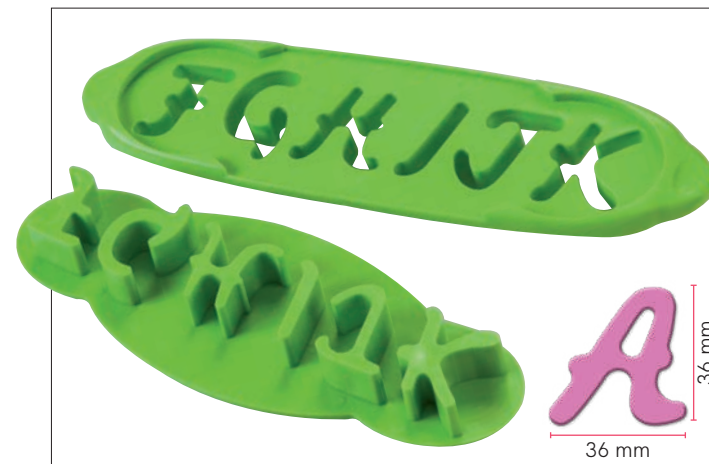

Cutter Lettere - GRANDI Letter Cutter - BIG

40-WA002
 Il kit include: stampi lettere dalla A alla Z, set 5 pz
 The kit includes: letters cutters from A to Z, set of 5 pcs

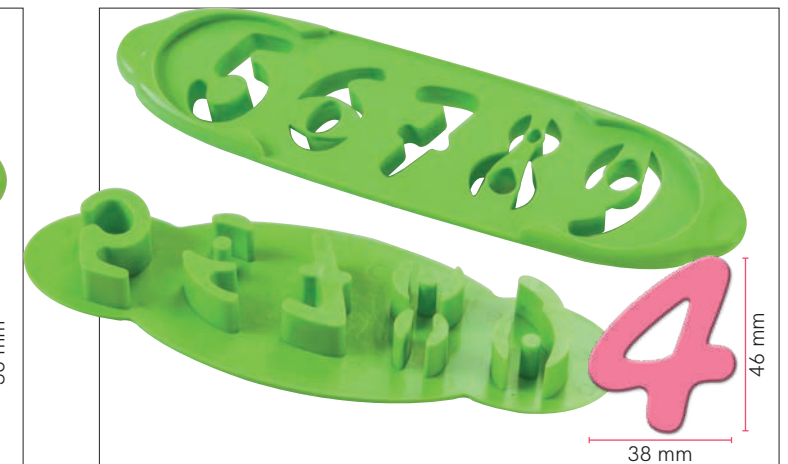

Cutter Numeri - GRANDI Numbers Cutter - BIG

40-WA003
 Il kit include: stampi dallo 0 al 9 set 2 pz
 The kit includes: cutters from 0 to 9, set of 2 pcs



Cutter Letterine Small Letter Cutter

40-WA008
 Il kit include: stampi lettere dalla A alla Z, set 5 pz
 The kit includes: letters cutters from A to Z, set of 5 pcs

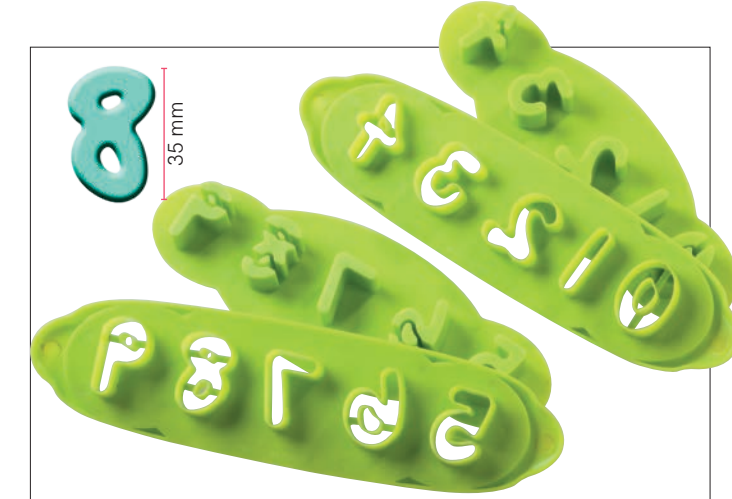

Cutter Numerini Small Numbers Cutter

40-WA009
 Il kit include: stampi dallo 0 al 9 set 2 pz
 The kit includes: cutters from 0 to 9, set of 2 pcs



Mattarelli in teflon - Teflon Rolling pin
40-W021 - Piccolo/Small Ø25mm - 230mm
40-W154 - Medio/Medium Ø45mm - 350mm
40-W022 - Lungo/Long Ø45mm - 500mm



Set 8 Anelli - Set 8 Ring
40-W164A
 Spessore - Thickness
 4-5-6-10mm per/for:
 40-W021 Ø25mm



Fiocchi neve - Snowflakes
40-W010S
 Ø25mm - Ø40mm - Ø56mm



Agrifoglio - Holly
40-W043S
 22x20mm - 30x28mm - 45x40mm

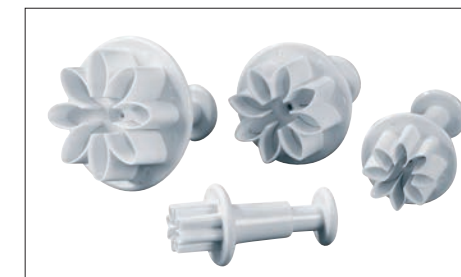

Margherita - Daisy
40-W014S
 ø12 - 18 - 25 - 33mm



Paletta per lisciare - Smoother
40-W004



Kit 3 rotelline - 3 wheels cutter kit
40-W052



Sugar gun
40-WA007
 Il kit include 20 dischetti intercambiabili
 The kit includes 20 interchangeable discs



Fiore 6 petali - 6 petals flower
40-W161S
 ø14 - 18 - 25 - 33mm



Foglie rosa - Rose leaves
40-W016S
 27x19 - 32x21 - 40x27mm



Ovali doppio taglio - Double cutter
40-W026
 33x23 - 30x20 - 49x33 - 44x28
 68x46 - 60x40 - 86x60 - 78x50mm



Cutter effetto imbottitura
Quilted effect cutter
40-W198V
 Misura-Size: 120x90mm

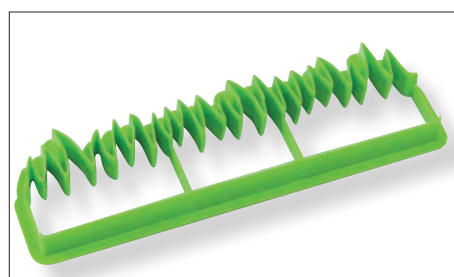

Cutter erba - Grass cutter
40-W199V
 206x58mm



Cutter bisturi - Scalpel cutter
40-W031



Cuoricini - Hearts
40-W013S
 6x7mm - 8x10mm - 13x14mm

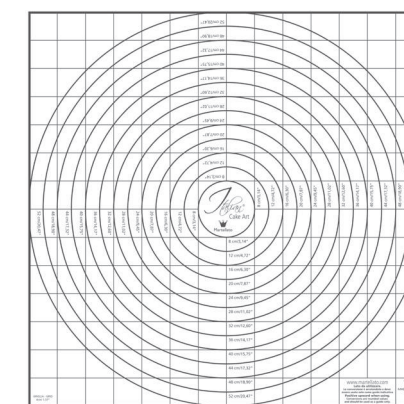

Tappeto stendipasta in plastica - Plastic mat for dough rolling out
 con gommatura antiscivolo - with non-slip rubber coating
40-W167 - 60x58cm

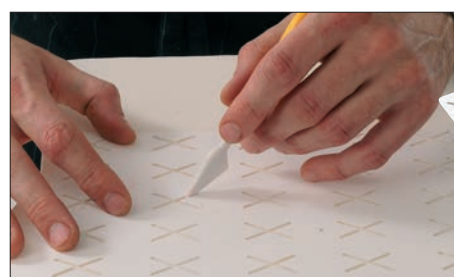

Stencil rombi per effetto imbottitura
Rhomb stencil for quilted effect
40-W108
 Misura-Size: 200x330mm



AMPIA GAMMA DISPONIBILE NEL CATALOGO DEDICATO AL CAKE DESIGN
 SEE ALL THE ITEMS ON OUR CAKE DESIGN CATALOGUE

AIRBRUSHES

Aeropenne professionali per colorare cioccolato e dolci, alimentate per gravità con forma ad imbuto per una facile pulizia e un flusso di colorante più efficiente. Presentano un regolatore di flusso ad azione singola o doppia e sono disponibili diverse misure di ugelli e capacità di serbatoi per adattarsi ad ogni esigenza di decorazione, rispondendo alle diverse necessità di precisione e velocità.

Professional airbrushes for colouring chocolate and sweets, gravity-fed funnel-shaped cup for a easy cleaning and a more efficient dye flow. They have a single or double action flow regulator and different nozzle sizes and tank capacities are available to adapt to any decoration need, responding to different precision and speed requirements.



DECOAIR 2
Cap. 7 CC
Ugello/Nozzle Ø 0,3mm
DUAL ACTION



DECOAIR 3
Cap. 2 CC
Ugello/Nozzle Ø 0,2mm
DUAL ACTION



DECOAIR 5
Cap. 20 CC - 40 CC
Ugello/Nozzle Ø 0,2mm
DUAL ACTION



DECOAIR 6
Cap. 2 CC - 5 CC - 13 CC
Ugello/Nozzle Ø 0,3mm
SINGLE ACTION

Dispositivo professionale portatile per la nebulizzazione del colorante alimentare. Funzionamento con pistone in teflon senza olio di lubrificazione. Pressione di esercizio costante garantita dal regolatore. Una soluzione perfetta per tutti i lavori di aerografia e nebulizzazione del colorante alimentare.

Portable professional device for the atomisation of food dye. Operation with teflon piston without lubrication oil. Constant working pressure guaranteed by the regulator. A perfect solution for all airbrushing and atomising of food dye.



DECOMP 7
4 BAR Potenza - Power: 1/5 HP
Volume aria min./litres - Air output per min./litres: 23-25L/min
Voltaggio - Voltage: 220-240V / 50HZ 110-120V/60HZ 220V / 60HZ
Pressione Massima - Max.pressure: 6.5bar/95PSI



DECOMP 9
6 BAR - Potenza - Power: 1/3 HP
Volume aria min./litres - Air output per min./litres: 30-35L/min
Voltaggio - Voltage: 220-240V / 50HZ 110-120V/60HZ 220V / 60HZ
Pressione Massima - Max.pressure: 6.5bar/95PSI
cavo di collegamento per aerografo incluso connection cable for airbrush included

MINI AIRBRUSH

DECOCPO2

Il kit completo per piccole decorazioni include:

- Penna aerografa a doppia azione, Ø 0,2mm;
- Mini Compressore da 1,5 BAR;
- Supporto per penna aerografa; • Borsa nera da viaggio.

Complete kit for small decorations includes:

- Airbrush double action, Ø 0.2mm;
- Mini compressor 1,5 BAR;
- Support for airbrush; • Black travel bag.



ACCESSORIES



DECOF01
Filtro aerografo
Airbrush filter

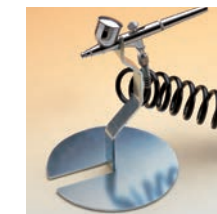

MD 2
Sostegno aerografo
Airbrush holder



DECOH01
Sostegno aerografo
Airbrush holder

STENCIL

Realizzati in resistente materiale plastico traslucido, gli stencil per aerografia permettono di produrre decorazioni su superfici verticali e curve. Ideali per decorare torte da ricorrenza personalizzate.

Made of resitant translucent plastic material, the airbrush stencils allow you to produce decorations on vertical and curved surfaces. Ideal for decorating personalized cakes.

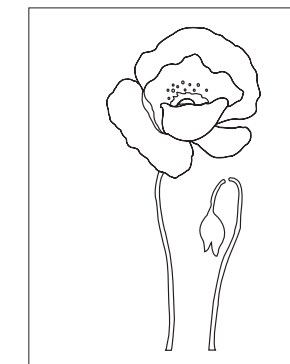

40-WM038
Papavero grande e bocciolo
Big poppy and bud stencil
130x65 mm



40-WM039
Papaveri e bocciolo
Big, small and bud poppy
110x62 mm - 60x30 mm

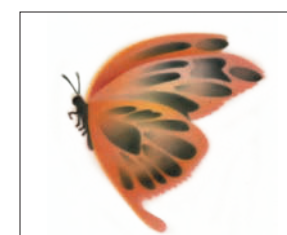

40-WM007
Farfalle - Butterflies
92x78mm - 50x43mm

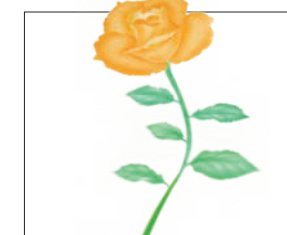

40-WM027
Rosa aperta - Open rose
93x150mm

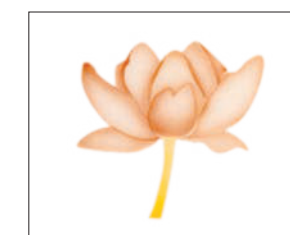

40-WM042
Loto - Lotus Flower
106x101mm



40-WM506
Loto - Lotus Flower
132x152mm KIT 2 STENCIL



40-WM045
Savana
230x230mm



40-WR002
Pois
230x230mm

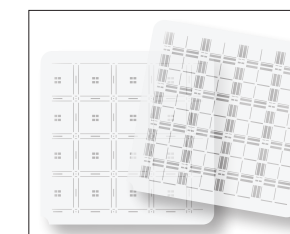

40-WR003
Tartan
230x230mm KIT 2 STENCIL



40-WM046
Pied de poule
230x230mm

STENCIL

Decorative



Pratici e veloci stencil per decorare torte, vaschette gelato, piatti e qualsiasi altro dessert. In materiale plastico per alimenti. Misure: Ø260mm. Spessore 0,8 mm

Practical and fast stencils to decorate cakes, ice cream, dishes and any other dessert. Made of food safe plastic. Sizes: Ø260mm. Thickness 0,8 mm



MINI STENCIL

In materiale plastico per alimenti. Misure: Ø95mm. Spessore 0,8 mm. Made of food safe plastic. Sizes: Ø95mm. Thickness 0,8 mm

Ideali per monoporzioni
Ideal for single serving



cap. 450 g
SETACIOK2
Ø73 h120mm

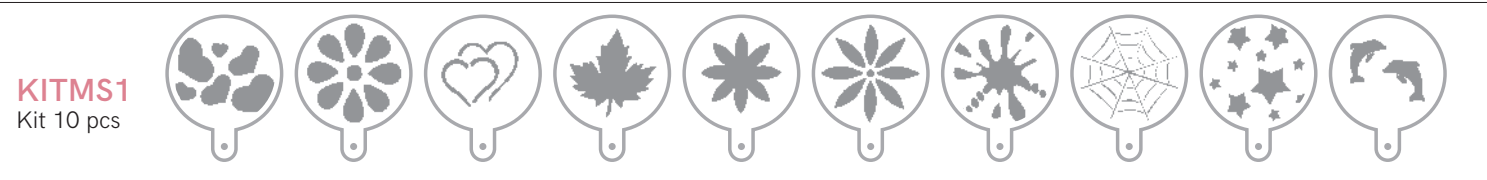

CREATIVE STENCIL

Stencil in plastica bianca
White plastic stencil
Misura - Size: 295x200mm



PMFORK
30x125 x h1,5mm - 12pcs



PMSPOON
30x130 x h1,5mm - 12pcs



PMKNIFE
20x130 x h1,5mm - 14pcs

Stencil in plastica
trasparente/Transparent
plastic stencil.
Misura - Size: 310x510mm



SCSP01
130x30 x h2mm - 30pcs



SCSP03
75x35x h2mm - 40pcs

DECORATING TOOLS



Coltello - Knife
50WA006B

1 coltello / 1 knife



Kit Attrezzi decoro - Modelling tool set
50WA004B

12 strumenti doppia punta + 1 coltello +
1 raschietto/12 dual-heads tools + 1 knife +
1 scraper



Kit Attrezzi decoro - Modelling tool set
50WA005B

12 strumenti doppia punta + 1 coltello +
1 raschietto/12 dual-heads tools + 1 knife +
1 scraper



Coltello - Knife
40-WA006V

1 coltello / 1 knife

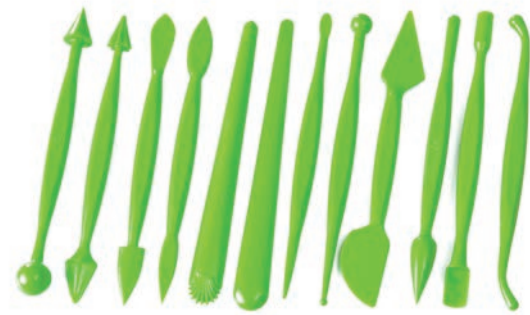

Kit Attrezzi decoro - Modelling tool set
40-WA004V

12 strumenti doppia punta
12 dual-heads tools

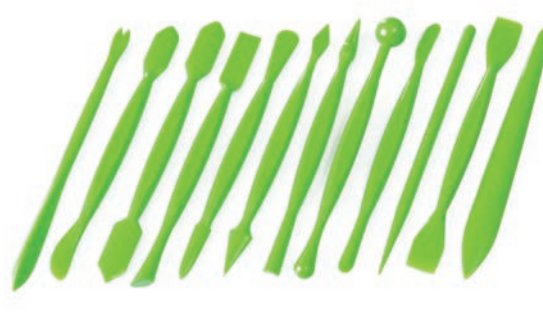

Kit Attrezzi decoro - Modelling tool set
40-WA005V

12 strumenti doppia punta
12 dual-heads tools

DECORATIVE STENCIL

Griglie in materiale plastico per creare
decori con il cioccolato e con biscuit.
Plastic grills for chocolate and biscuit
decorations.
Spessore/Thickness: 8 mm

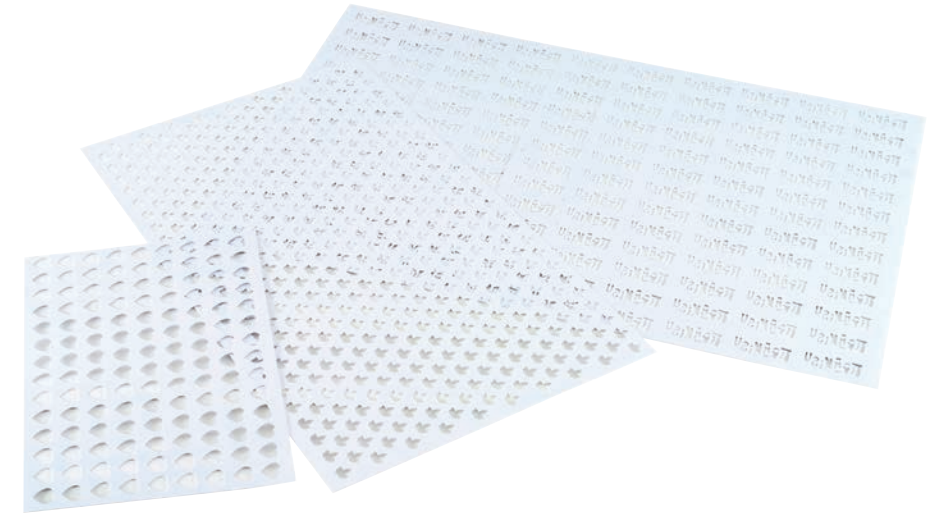

Size cm	Cod.
60x40	GD 03
30x20	GS03

Decoro/decor.: Ø6 mm



Size cm	Cod.
60x40	GD 04
30x20	GS04

Decoro/decor.: 11 mm



Size cm	Cod.
60x40	GD 06

Decoro/decor.: 17 x 17 mm



Size cm	Cod.
60x40	GD 07

Decoro/decor.: 20 x 3 mm

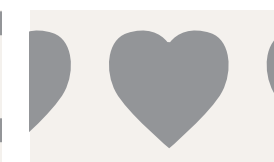

Size cm	Cod.
60x40	GD 08

Decoro/decor.: 16 x 16 mm



Size cm	Cod.
60x40	GD 09

Decoro/decor.: 9 x 7,5 mm



Size cm	Cod.
60x40	GD 10

Decoro/decor.: 15 x 6,5 mm



Size cm	Cod.
60x40	GD 05

Decoro/decor.: 9 x 9 mm



Size cm	Cod.
60x40	GD 11
30x20	GS11

Decoro/decor.: 9 x 9 mm



Size cm	Cod.
60x40	GD 13

Decoro/decor.: 13 x 15 mm



Size cm	Cod.
60x40	GD 14

Decoro/decor.: 20 x 15 mm



Size cm	Cod.
60x40	GD 15

Decoro/decor.: 175 x 282 mm

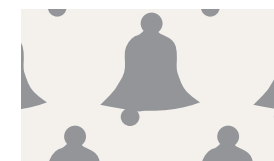

Size cm	Cod.
60x40	GD 16

Decoro/decor.: 14 x 15 mm



Size cm	Cod.
60x40	GD 17
30x20	GS17

Decoro/decor.: max15x15 mm



Size cm	Cod.
60x40	GD 18

Decoro/decor.: 14 x 10 mm



Size cm	Cod.
60x40	GD 01

Decoro/decor.: Ø6,5 mm



Size cm	Cod.
60x40	GD 02

Decoro/decor.: Ø9,5 mm



Size cm	Cod.
60x40	GD 12

Decoro/decor.: Ø15 mm



Size cm	Cod.
60x40	GD 21
30x20	GS21

Decoro/decor.: 13 x 15 mm



Size cm	Cod.
60x40	GD 22
30x20	GS22

Decoro/decor.: 50 x 15 mm

DECORATIVE COMBS

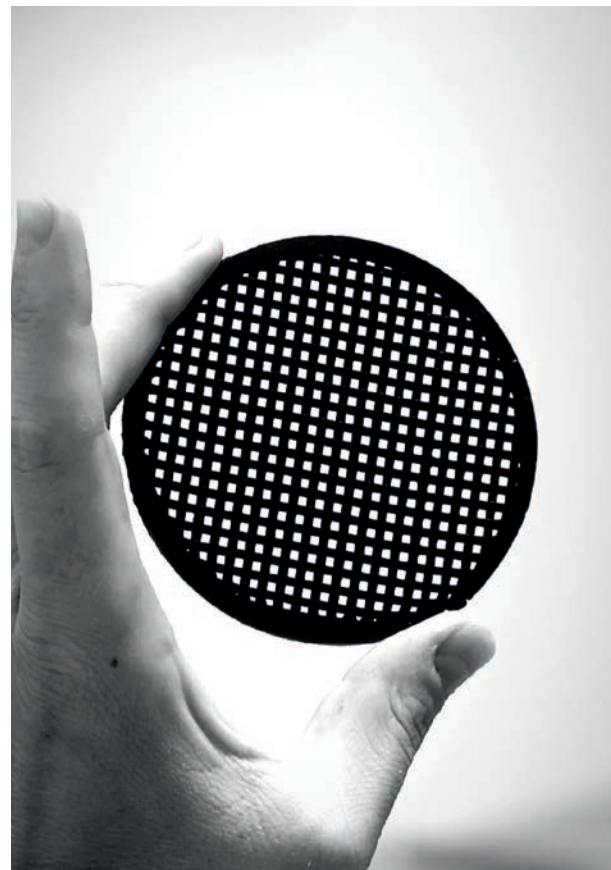

Pettini in materiale plastico e gomma con doppio decoro, ideali per biscuit e cioccolato.

Combs in plastic and rubber with double decoration, ideal for biscuits and chocolate.

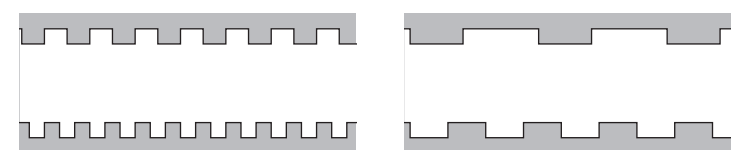

cm	Cod.
70	PD1/2
34	PDM1/2
17	PDS1/2

cm	Cod.
70	PD3/4
34	PDM3/4
17	PDS3/4

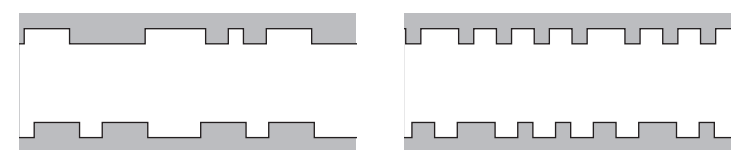

cm	Cod.
70	PD5/6
17	PDS5/6

cm	Cod.
34	PDM7/8

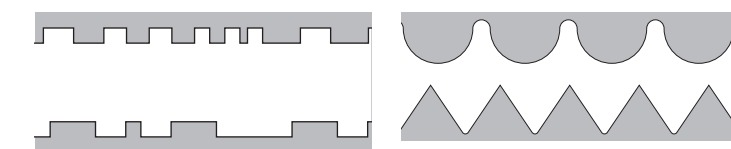

cm	Cod.
34	PDM9/10

h cm	Cod.
70	PD13/14

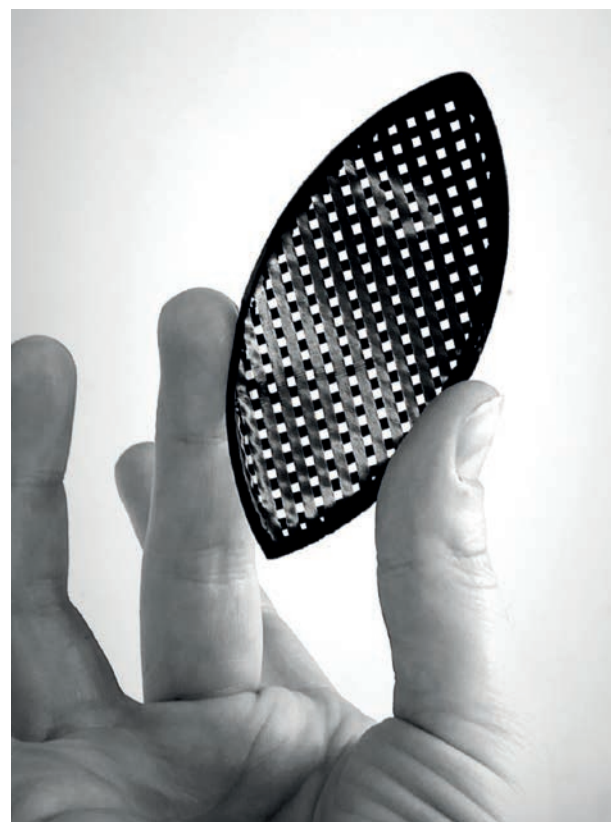

Pettine per decorazioni a 3 colori
Three-colour decorating comb
PD11/12 - 70cm

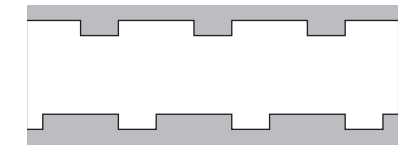

Pettini in materiale plastico per triplo decoro.
Plastic combs for triple decoration.

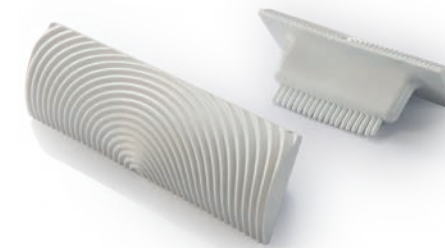

Tampone effetto legno
Wood motif decoration comb
materiale plastico - plastic
TFL10 - 10cm
TFL15 - 15cm

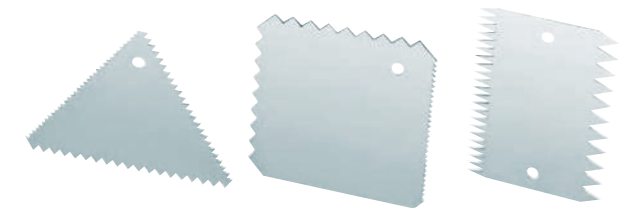

Pettini da decoro/Decorative combs
Acciaio inox/Stainless steel 18/8
Spessore/Thickness 0,50 mm
INOX 3
Triangular 100x103 mm - Square 100x100 mm -
Rectangular 56x110 mm

DECORATIVE MATS

Tappeto in silicone per decori in rilievo. Silicone carpet for embossed decorations.
Size: 565x370 mm



RELIEF1
Misura - Size:
h 37mm

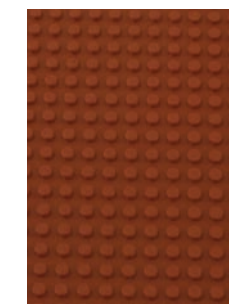

RELIEF2
Misura - Size:
Ø 4mm



RELIEF4
Misura - Size:
h 30mm



RELIEF5
Misura - Size:
h 30mm

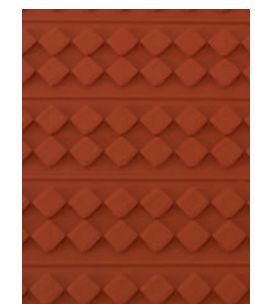

RELIEF7
Misura - Size:
h 30mm



RELIEF8
Misura - Size:
h 30mm

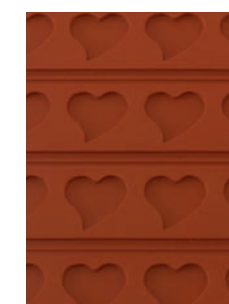

RELIEF9
Misura - Size:
h 30mm



RELIEF10
Misura - Size:
h 30mm

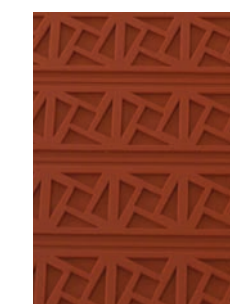

RELIEF11
Misura - Size:
h 30mm



RELIEF12
Misura - Size:
h 30mm

BANQUETING & DISPLAY

Design e qualità contraddistinguono gli eleganti ed infrangibili articoli ideali per ogni professionista del settore HORECA, della pasticceria e della gelateria. **Realizzati da Martellato** con materiale di alta qualità, che conferisce, oltre alla resistenza, anche lucidità e trasparenza. Prodotti in Italia, gli articoli Martellato rappresentano la più valida alternativa al vetro.

Design and quality characterise the elegant and unbreakable disposable items ideal for every professional in the HORECA, pastry and ice-cream sector. **Made by Martellato** with high quality material, which gives, in addition to resistance, also lucidity and transparency. Produced in Italy, the Martellato items provide the most valid alternative to glass.



I RIUTILIZZABILI

Rispettano l'ambiente due volte. Grazie al materiale di alta qualità con il quale sono prodotti, i piattini per individual dessert - così come tutti i gli articoli della linea Elegant Catering Solution - **possono essere riutilizzati più volte.** E una volta gettati, sono riciclabili al 100%.

THE REUSABLE

They respect the environment twice. Thanks to the high quality material with which they are made, the plates for individual desserts - like all the items of the Elegant Catering Solution line - **can be reused several times.** And once disposed, they are 100% recyclable.



SLICE

Coppetta/Cup
PMFT001
135 x 69 x h 42 mm - cap. 160 ml
pack 100 pcs

Coperchio/Lid
PMOFT001C
pack 100 pcs

Tagliapasta/Cutter
Slice
31CUT04

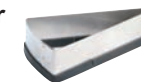



ECLAIR

Coppetta/Cup
PMOCL001
137 X 37 h 41 mm - cap. 120 ml
pack 100 pcs

Coperchio/Lid
PMOCL001C
pack 100 pcs

Tagliapasta
Eclair 25x125mm
31CUT01



BUCKET

Coppetta/Cup
PMOTO005
Ø78 h 57 mm - cap. 210 ml
pack 100 pcs

Coperchio/Lid
PMOTO005/C
pack 100 pcs

Tagliapasta
Bucket Ø78mm
31CUT03





PENTA

CAP. 120 ML
68x65 h 56 mm
PMOPE001 - pack 100 pz

WAFLE

CAP. 70 ML
64x62 h 59 mm
PMOCO013 - pack 100 pz

SOFT ICE

CAP. 105 ML
Ø70 h 59 mm
PMOCO014 - pack 100 pz

GREEK

CAP. 190 ML
92x90 h 75 mm
PMOCO010 - pack 100 pz

CAP. 120 ML
73x71 h 61 mm
PMOCO009 - pack 100 pz

CAP. 50 ML
50x48 h 57 mm
PMOCO008 - pack 100 pz

WAVE

CAP. 200 ML
100x70 h 83 mm
PMOCE003 - pack 100 pz

CAP. 120 ML
85x60 h 70 mm
PMOCE002 - pack 100 pz

CAP. 50 ML
64x46 h 53 mm
PMOCE001 - pack 100 pz

VELA

CAP. 200 ML
90x83 h 74 mm
PMOCO015 - pack 100 pz

CAP. 140 ML
73x81 h 67 mm
PMOCO012 - pack 100 pz

CAP. 85 ML
63x69 h 57 mm
PMOCO011 - pack 100 pz



CUBÒ

CAP. 58 ML
50x50 h 55 mm
PMOCU004 - pack 100 pz



COPERCHI/LIDS
PMOCU002/C - pack 100 pz



TRIANGLE

CAP. 175 ML
81x83 h 65 mm
PMO07.00 - pack 100 pz



COPERCHI/LIDS
PMO07/C - pack 100 pz



JAPAN

CAP. 87 ML
Ø50 h 54 mm
PMOJA002 - pack 100 pz

CAP. 47 ML
Ø42 h 43 mm
PMOJA001 - pack 100 pz



HEART

CAP. 100 ML
73x64 h 52 mm
PMOLO001 - pack 100 pz



COPERCHI/LIDS
PMOLO001/C - pack 100 pz



CUP

CAP. 150 ML
Ø75 h 73 mm
PMOCO003 - pack 100 pz

CAP. 135 ML
Ø70 h 67 mm
PMOCO002 - pack 100 pz

CAP. 90 ML
Ø65 h 55 mm
PMOCO001 - pack 100 pz



DROP

CAP. 190 ML
Ø75 h 80 mm
PMOCO006 - pack 100 pz



CYLINDER

BUBBLE

CONE

CLASSIC

CLASSIC

TUBE

CAP. 190 ML
Ø65 h 85 mm
PMOCO007 - pack 100 pz

CAP. 215 ML
Ø90 h 75 mm
PMOCO004 - pack 100 pz

CAP. 165 ML
Ø90 h 75 mm
PMOCO005 - pack 100 pz

CAP. 170 ML
Ø60 h 90 mm
PMOTO004 - pack 100 pz

CAP. 120 ML
Ø55 h 70 mm
PMOTO003 - pack 100 pz

CAP. 90 ML
Ø50 h 65 mm
PMOTO002 - pack 100 pz

CAP. 65 ML
Ø42 h 65 mm
PMOTO001 - pack 100 pz

CAP. 80 ML
Ø40 h 85 mm
PMO08.00 - pack 100 pz



SQUARE

CAP. 175 ML
57x57 h 73 mm
PMOCU003 - pack 100 pz



COPERCHI/LIDS
PMOCU003/C - pack 100 pz



SQUARE

CAP. 125 ML
50x50 h 70 mm
PMOCU002 - pack 100 pz



COPERCHI/LIDS
PMOCU002/C - pack 100 pz



SQUARE

CAP. 60 ML
40x40 h 55 mm
PMOCU001 - pack 100 pz

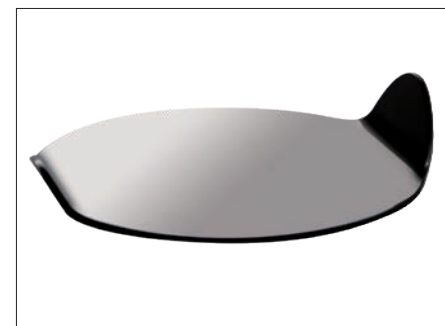

TONDO

85x96 h 20 mm - pack 100 pz
PL00100 - trasparente/clear
PL00101 - bianco/white
PL00102 - nero/black



QUADRO

80x97 h 20 mm - pack 100 pz
PL00200 - trasparente/clear
PL00201 - bianco/white
PL00202 - nero/black



RETTANGOLO

60x140 h 20 mm - pack 100 pz
PL00300 - trasparente/clear
PL00301 - bianco/white
PL00302 - nero/black



ZEN BOWL

CAP. 460 ML
100x118 h 70 mm - pack 50 pz
ZENB000 - trasparente/clear
ZENB001 - bianco/white
ZENB002 - nero/black



ZEN SMALL TRAY

100x118 h 6 mm - pack 50 pz
ZENB000C - trasparente/clear



ZEN TRAY

110x245 h 180 mm - pack 50 pz
ZENTR00 - trasparente/clear
ZENTR01 - bianco/white
ZENTR02 - nero/black





WING

CAP. 11 ML
105 x 50 h 30 mm - pack 100 pz
PMO12.00 - trasparente/clear
PMO12.01 - bianco/white
PMO12.02 - nero/black



SINGLE

CAP. 15 ML
65 x 65 h 15 mm - pack 100 pz
PMO13.00 - trasparente/clear
PMO13.01 - bianco/white



DOUBLE

CAP. 20 ML
110 x 65 h 20 mm - pack 100 pz
PMO14.00 - trasparente/clear



MINI BOWL

CAP. 50 ML
75 x 75 h 30 mm - pack 100 pz
PMO11.00 - trasparente/clear
PMO11.01 - bianco/white
PMO11.02 - nero/black



TRIANGLE

CAP. 20 ML
85 x 85 h 15 mm - pack 100 pz
PMO09.00 - trasparente/clear
PMO09.01 - bianco/white
PMO09.02 - nero/black



BLOW

CAP. 30 ML
85 x 85 h 30 mm - pack 100 pz
PMO10.00 - trasparente/clear
PMO10.01 - bianco/white
PMO10.02 - nero/black



CAP. 120 ML
Ø72 h 51 mm - pack 100 pz
PMOVA002.00 - trasparente/clear



CAP. 120 ML
Ø75,5 h 35 mm - pack 100 pz
PMOVA003.00 - trasparente/clear



CAP. 120 ML
Ø67,5 h 58 mm - pack 100 pz
PMOVA001.00 - trasparente/clear

CATERING DISPLAYS

Eleganti espositori in plexiglass dal **design ricercato e moderno, prodotti in Italia**. Sono ideali per allestire raffinati buffet per **cerimonie** o **incontri d'affari**. Resistenti e facili da montare e trasportare, sono completamente atossici.

Elegant plexiglass displays with **modern design, produced in Italy**. They are ideal for setting up refined buffets for **ceremonies** or **business meetings**. Resistant and easy to assemble and transport, they are completely non-toxic.

MADE IN ITALY



FOLD SINGLE

80D0900

Ingombro/total size: 32,5 x 33,5 h 18 cm
Superficie di appoggio/support surfaces 16,5 x 32,5 cm



FOLD DOUBLE

80D1000

Ingombro/total size: 65 x 33,5 h 18 cm
Superficie di appoggio/support surfaces 16,5 x 65 cm



MOSAIC

- 80D0600 - MOSAIC 4** - Misura/size: Ø 24 h 4,5 cm
- 80D0700 - MOSAIC 8** - Misura/size: Ø 24 h 8,5 cm
- 80D0800 - MOSAIC 12** - Misura/size: Ø 24 h 12,5 cm



MOSAIC KIT

- 80D0500**
- Kit 3 displays: Ø 24 h 4,5 - 8,5 - 12,5 cm



CROSS

- 80D0200 - CROSS SMALL**
Misura/size: 25 x 25 h 13,5 cm
- 80D0300 - CROSS BIG**
Misura/size: 30 x 30 h 18,5 cm
- 80D0400 - CROSS DOUBLE**
Misura/size: 20 x 49,5 h 13,5 cm

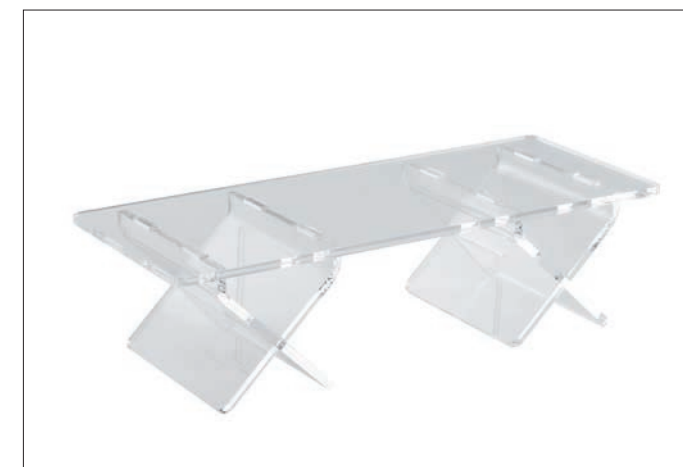

CROSS DOUBLE

- 80D0400 - CROSS DOUBLE**
Misura/size: 20 x 49,5 h 13,5 cm

CROSS KIT

- 80D0100 - CROSS KIT**
Kit 3 displays: 25 x 25 h 13,5 cm + 30 x 30 h 18,5 cm + 20 x 49,5 h 13,5 cm



STAIRWAY

80D1900

4 Piani/levels: 35 x 35 h 26 - 30 x 30 h 21 - 25 x 25 h 16 - 20 x 20 h 12 cm

Componibili in infinite varianti per creare originali effetti coreografici/Combinable in endless variations, they can offer original coreographic effects.

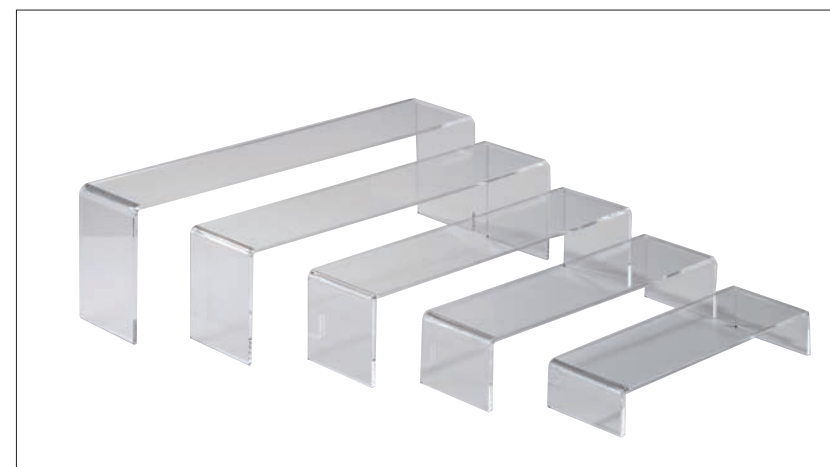

LEVELS

80D2000

5 Piani/levels: 50 x 10 h 15 - 45 x 10 h 12,5 - 40 x 10 h 10 - 35 x 10 h 7,5 - 30 x 10 h 5 cm

Componibili in infinite varianti per creare originali effetti coreografici/Combinable in endless variations, they can offer original coreographic effects.



COD33501

Display in plexiglass satinato e bianco/satin-finish and white plexiglass display

Misura/size: h 50,5 cm

Piatti/plates: 63,5 x 35 - 52,5 x 25,5 - 43x21,5 - 35 x 19 - 28 x 14,5 cm

Distanza tra ripiani/distance between shelves: 12 cm

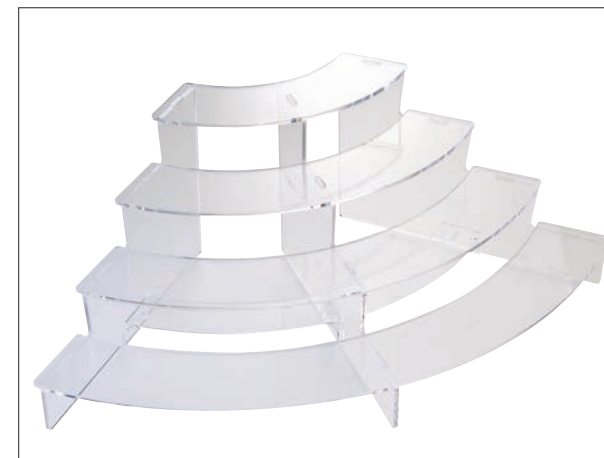

COD. 320

Misura/size: h 22,5 cm

Piatti/plates: 65 x 35,5 cm



COD33701

Piatti/plates: 50 x 20 h 20,5 - 50 x 20 h 14 -

50 x 20 h 7 cm

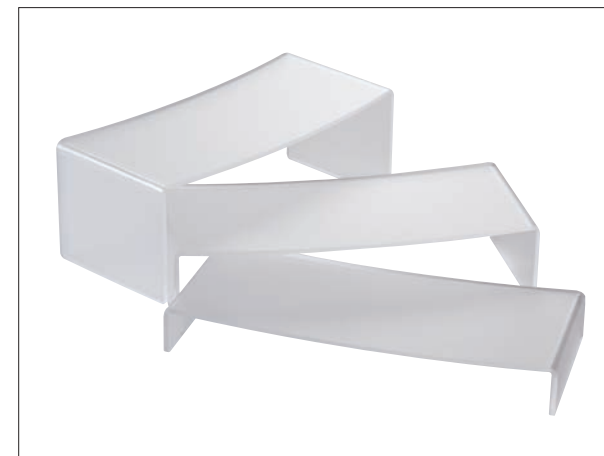

COD33906

Satinato/Satin-finish plexiglass

Piatti/plates: 35,5x 17 h 22 - 7 x 17 h 9 -

40 x 17 h 5 cm

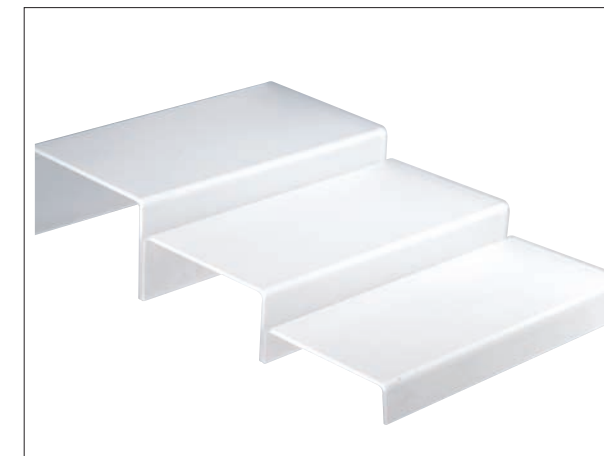

COD. 310

Piatti/plates: 40 x 20 h 12 - 40 x 18 h 8 -

40 x 16 h 4 cm



COD. 309

Misura/size: h 4 - 11 - 18 - 25 cm

Piatti/plates: 24,5 x 24,5 cm



COD34001

Piatti/plates: 49 x 15,5 h 18 - 49 x 15,5 h 13 -

49 x 15,5 h 8 cm



COD33401

Misura/size: 42 x 42 h 30,5 cm
 Piatti/plates: Ø 42 - 37 - 25 cm
 Distanza tra ripiani/distance between shelves: 12 cm



COD. 510

Misura/size: 41 x 41 h 67 cm
 Piatti/plates: 40 x 40 - 35 x 35 - 30 x 30 - 20 x 20 cm



COD33201

Misura/size: 38 x 53,3 h 71 cm
 Piatti/plates: 2 piatti/plates 33 x 26 cm + 2 piatti/plates 29 x 22 cm



COD33301

Misura/size: 34 x 34 h 37,5 cm
 Piatti/plates: Ø 34 - 26 - 15,5 cm
 Distanza tra ripiani/distance between shelves: 11 cm



COD. 305

Piatti/plates: Ø 28 h29 - 38 x 30 h 21 - 38 x 30 h 13 - 38 x30 h 5 cm



COD. 307

Misura/size: 40 x 27 h 29 - 40 x 27 h 21 - 40 x 27 h 13 - 40 x 27 h 5 cm



COD60501

Misura/size: 49 x 49 x h 41 cm
 Piatti/plates: 49 x 49 - 39 x 39 - 29 x 29 - 19 x 19 cm
 Distanza tra ripiani/distance between shelves: 12 cm



COD. 603

Misura/size: Ø 50 x h 58 cm
 Piatti/plates: Ø 50 - 42 - 34 - 26 - 18 cm



COD. 32901

Misura/size: 35 x 55,5 h 27 cm
 Piatti/plates: 35 x 25 - 30 x 12 -
 28 x 18 cm



COD35101

Misura/size: h 38 cm
 Piatti/plates: 50 x 50 h 12 - 36 x 36 h 12 -
 22,5 x 22,5 h 12 cm



COD. 604

Misura/size: 22 x 27 h 30 cm



COD33608 - Nero/black

Misura/size: 65 x 35 h 27 cm
 Piatti/plates: 37 x 26 - 30 x 22 - 22 x 16 cm



COD. 32717 - Lilla/lilac

Misura/size: 52 x 43,5 h 62 cm
 Piatti/plates: 34 x 18 - 43x 23 - 46,5 x 25,5 -
 42,5 x 23,5 cm



Misura/size: 56 x 35 h 59 cm
COD32108 - Nero/black
COD32100 - Bianco/white
COD. 321 - Arancione/orange



Misura/size: Ø 56 h 62 cm
 Piatti/plates: Ø 56 - 46 - 33 - 22 cm
COD30408 - Nero/black
COD30400 - Bianco/white
COD. 304 - Verde/green

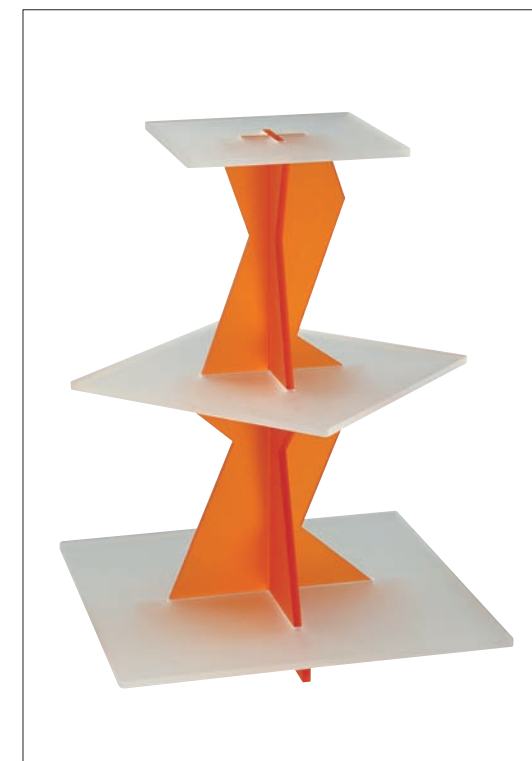

COD. 308 - Arancione/orange
 Misura/size: 40 x 40 h 53 cm
 Piatti/plates: 40 x 40 - 30 x 30 - 22 x 22 cm

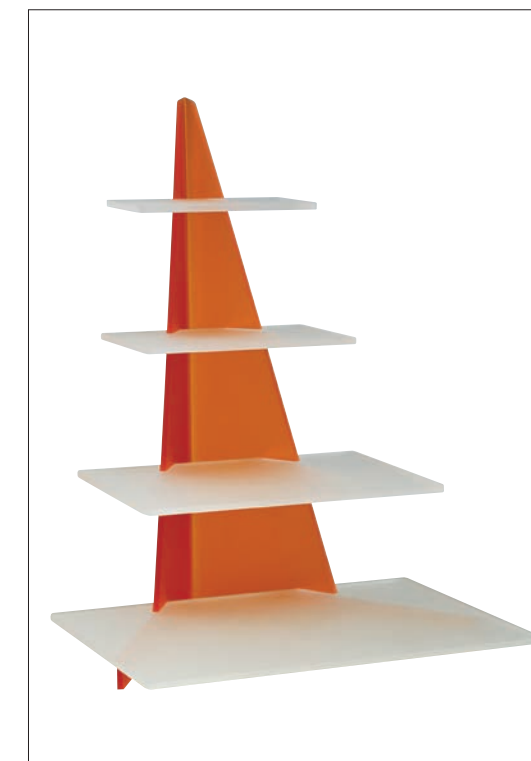

COD. 300 - Arancione/orange
 Misura/size: 54 x 47 h 63 cm
 Piatti/plates: 47 x 34 - 37 x 25 - 27 x 17 - 23 x 13 cm



COD. 322 - Arancione/orange
 Misura/size: Ø40,5 h 49,5 cm
 Piatti/plates: Ø40,5 - 39 - 38 - 35,5 - 31,5 cm



Misura/size: 45 x 30 h 61 cm
 3 Piatti/plates: 32 x 24 cm
COD. 32418 - Rosa/pink
COD. 32416 - Marrone/brown



COD. 301 - Giallo/yellow
 Misura/size: 70 x 40 h 62 cm
 Piatti/plates: 70 x 40 - 63 x 35 - 52 x 26 - 42 x 21 cm



COD. 33118 - Rosa/pink
 Misura/size: h 3,6 - 11 - 17,6 - 25 cm
 Piatti/plates: 24,5 x 24,5 cm

CAKE STANDS

LOOP



Serie di alzate in plexiglass **componibili** con elementi **intercambiabili** dal design moderno ed elegante. Da 3 a 5 piani a cerchio o semicerchio, con **colonne di diverse altezze** che grazie al kit possono comporre diversi disegni estetici.

An elegant and modern design serie of plexiglass **modular** cake stands with **interchangeable** elements. From 3 to 5 circle or half circle shaped shelves, with little **columns of different heights** that can create different easthetic designs.



LOOP 5

80A1400

Misura/size: Ø 77 h 26 cm

5 Piatti/plates Ø26 cm

Columns: 1x h10 - 2x h18 - 2x h26 cm



LOOP 3

80A1500

Misura/size: Ø 65 h 26 cm

3 Piatti/plates Ø26 cm

Columns: 1x h10 - 1x h18 - 1x h26 cm



DEMI LOOP

80A1600

Misura/size: 65 x 45,5 h 35 cm

3 Piatti/plates Ø26 cm

Columns: 1x h10 - 1x h22 - 1x h35 cm

Kit complementari disponibili nella pagina seguente
Complementary kits available on the following page

LINEAR



Alzate componibili con elementi intercambiabili essenziali e minimalisti per esaltare l'esposizione delle creazioni. Adatte ai buffet ed alle vetrine. Le diverse misure ed altezze delle colonne le rendono modificabili e adatte a tutte le situazioni.

Essential and minimalist **modular** cake stands with **interchangeable elements** that enhance the exposition of creations. They are suitable either to buffets and showcases. The different sizes and heights of the **columns** make them **changeable** and suitable for all situations.



LINEAR 5

80A1800

Misura/size: 140 x 26 h 26 cm
5 Piatti/plates Ø 26 cm
Columns: 2x h10 - 2x h18 - 2x h26 cm



LINEAR 3

80A1700

Misura/size: 88 x 26 h 26 cm
3 Piatti/plates Ø 26 cm
Columns: 1x h10 - 1x h18 - 1x h26 cm

KIT elementi intercambiabili per le alzate LOOP e LINEAR Interchangeable KITS to LOOP and LINEAR models



80RIC02
5 pcs Ø 26 cm



80RIC04
5 pcs 20 x 20 cm



80RIC03
5 pcs: 2x Ø20 - 2x Ø25 -
1x Ø30 cm



80RIC05
6 pcs: 2x10 - 2x18 -
2x 26 cm

INFINITY



Alzata realizzata completamente in plexiglass, **configurabile in 3, 5 o 7 piatti** per soddisfare le diverse esigenze, completa di 18 colonnine che potranno facilmente essere inserite per comporre la torta.

Catering display made entirely of plexiglass, **configurable in 3, 5 or 7 plates** to meet different needs, complete with 18 small columns that can easily be inserted to compose the cake.



INFINITY

80A1300

Misura/size: Ø 40 h 69 cm - 7 piatti

Misure piatti: Ø 16 - 20 - 24 - 28 - 32 - 36 - 40 cm

18 colonne/columns h 10 cm

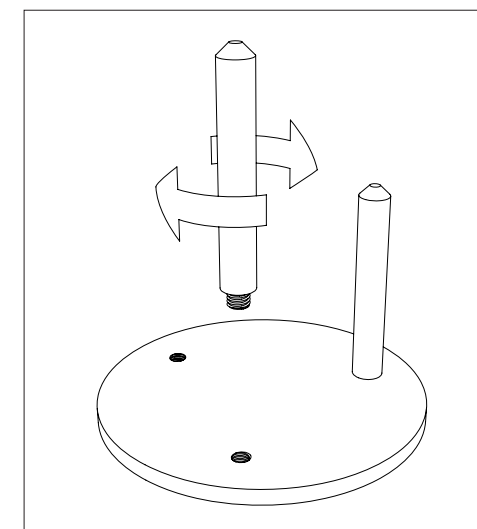

Dettaglio di montaggio delle colonne
Column assembly detail

BAROQUE



Romantiche nello stile e moderne nel materiale, queste alzate sono perfette per qualsiasi occasione, anche grazie alla gamma di colori. I **singoli elementi** possono, a seconda delle necessità, **comporsi in modo diverso** adattandosi agli spazi ed alle situazioni.

With a romantic style and modern materials, these cake stands are perfect in any occasion, thanks to its range of colours. **The individual elements** can, according to need, **compose themselves in different ways**, adapting to spaces and situations.



CRYSTAL BAROQUE Ø26 trasparente/clear

80A1100 - Kit 5 alzate/kit 5 displays
Misura/size: Ø 26 cm - 1 x h35 - 4x h 21cm
80A0900 - 1 alzata/1 display
Misura/size: Ø 26 cm h 21 cm
80A1000 - 1 alzata/1 display
Misura/size: Ø 26 cm h 35 cm



BLACK BAROQUE Ø26 nero/black

80A1108 - Kit 5 alzate/kit 5 displays
Misura/size: Ø 26 cm - 1 x h35 - 4x h 21cm
80A0908 - 1 alzata/1 display
Misura/size: Ø 26 cm h 21 cm
80A1008 - 1 alzata/1 display
Misura/size: Ø 26 cm h 35 cm



MINI BAROQUE Ø21 satinato/glazed

80-0106 - Misura/size: Ø 21 cm h 10,5 cm
80-0206 - Misura/size: Ø 21 cm h 16,5 cm
80-0306 - Misura/size: Ø 21 cm h 22,5 cm
nero/black
80-0108 - Misura/size: Ø 21 cm h 10,5 cm
80-0208 - Misura/size: Ø 21 cm h 16,5 cm
80-0308 - Misura/size: Ø 21 cm h 22,5 cm

MODULAR DISPLAY



3 PLATES

COD512

Misura/size: 67 x 37 h 21 cm
Piatti/plates: Ø 20 - 26 - 32 cm



5 PLATES

COD514

Misura/size: 100 x 53 h 39,5 cm
Piatti/plates: Ø 20 - 26 - 32 cm

ALZATE COMPONENTIBILI

Combinando tra loro le alzate si possono avere le composizioni più adatte alle proprie necessità.
By combining the stands you will have the compositions best suited to your needs.

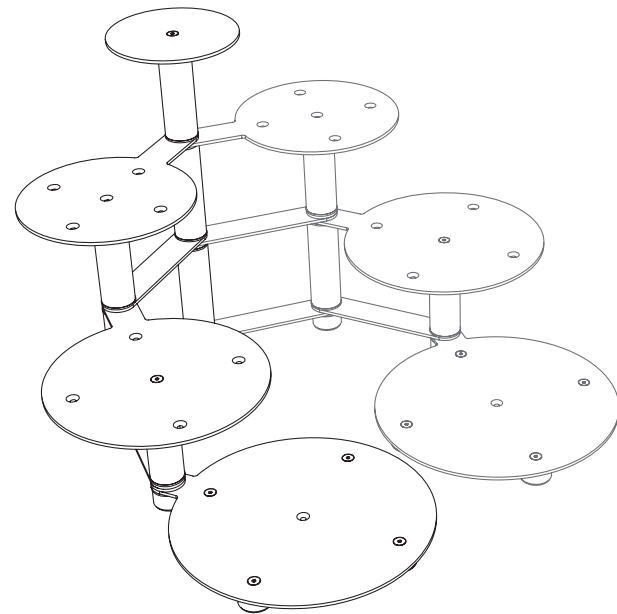

COD513 + COD513

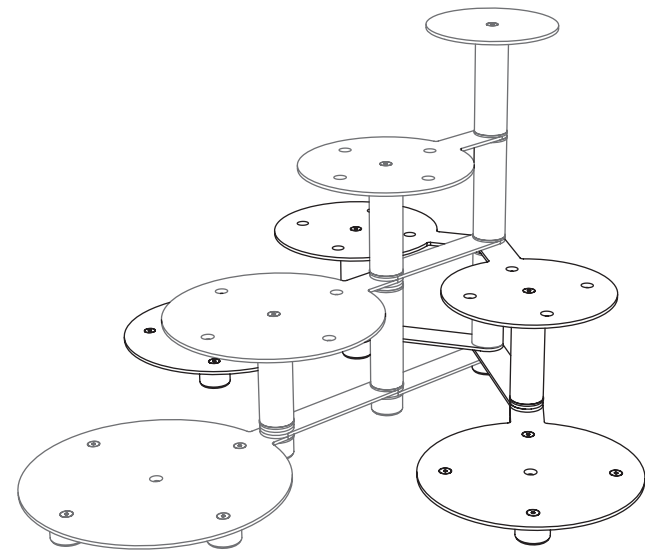

COD513 + COD514

4 PLATES

COD513

Misura/size: 70 x 65 h 56 cm
Piatti/plates: Ø 20 - 26 - 32 - 38 cm



Elegante alzata in plexiglass **modulabile**.
Il numero di piatti e la loro disposizione
possono essere variati a seconda delle
necessità.

Elegant **modular** plexiglass cake stand.
The number of plates and their
arrangement can be varied as needed.

ELEGANT

80A1900

Misura/size: h max 153 cm

Distanza tra i piatti/shelf spacing 16,5 cm

Piatti/plates: Ø 20 - 23,5 - 26,5 - 30 - 34
- 38 cm



ELEGANT

80A1900

Misura/size: h max 153 cm

Distanza tra i piatti/shelf spacing 16,5 cm

Piatti/plates: Ø 20 - 23,5 - 26,5 - 30 - 34 - 38 cm



ROUND

COD. 131

Misura/size: h 80 cm

Piatti/plates: Ø 24 - 29 - 34 - 39 cm

Porzioni/portions: 40/50



SQUARE

COD. 130

Misura/size: h 80 cm

Piatti/plates: 25 x 25 - 30 x 30 - 35 x 35 -
40 x 40 cm - Porzioni/portions: 80/85



HEART

COD. 132

Misura/size: h 80 cm

Piatti/plates: 25 x 21 - 30 x 26 - 35 x 30 - 40 x 34 cm
Porzioni/portions: 40/50

ROMANTIC

COD. 504

Misura/size: h 125 cm

Piatti in plexiglass satinato/Glazed plexiglass
plates: Ø 20 - 22 - 26 - 28 - 30 cm



FLORA COMPLETE

COD. 160

Misura/size: Ø 110 h 130 cm

Piatti/plates: 4x Ø 34 - 7 x Ø 26 - 1 x Ø 32 cm

Porzioni/portions: 145/155

FONTANINA non inclusa - not included



FLORA SMALL

COD. 163

Misura/size: Ø 40 h 45 cm



FLORA MEDIUM

COD. 162

Misura/size: Ø 70 h 42 cm



FLORA LARGE

COD. 161

Misura/size: Ø 110 h 51 cm

FONTANINA non inclusa - not
included



ROMANTICA

COD. 152

Misura/size: Ø 80 h 70 cm
Piatti/plates: 5 x Ø 26 - 5 x Ø 20 -
1 x Ø 34 cm
Porzioni/portions: 100/110



SEMIRAMIDE

COD. 153

Misura/size: 100 x 54 h 88 cm
Piatti/plates: 3 x Ø 32 - 3 x Ø 26 -
1 x Ø 38 cm
Porzioni/portions: 90/100



MANHATTAN

COD. 159

Misura/size: Ø 65 h 85 cm
Piatti/plates: 6 x Ø 26 - 1 x Ø 38 cm
Porzioni/portions: 100/110



STAIRWAY

COD. 150

Misura/size: h 80 cm
Piatti/plates: 23 x 18 - 29 x 17 - 39 x 19 -
50 x 22 - 60 x 25 cm
Porzioni/portions: 75/85



CLOVER

COD. 188 - Misura/size: 65 x 62 h 38 cm
Piatti/plates: 3 x Ø 28 - 3 x Ø 20 - 1 x Ø 22 cm
Porzioni/portions: 40/50



DAISY

COD. 180 - Misura/size: Ø 90 h 45 cm
Piatti/plates: 6 x Ø 28 - 1 x Ø 48 - 1 x Ø 30 cm
Porzioni/portions: 120/130



MEMPHIS

COD. 183 - Misura/size: Ø 70 h 50 cm
Porzioni/portions: 50/60



MILANO

COD. 192 - Misura/size: 62 x 62 h 38 cm
Piatti/plates: 4 x Ø 20 - 1 x Ø 25
Porzioni/portions: 30/35



GRADUS

COD. 190 - Misura/size: 88 x 30 h 43 cm
Piatti/plates: Ø 20 - 22 - 24 - 26 - 28 cm
Porzioni/portions: 45/55



CONE

COD. 185 - Misura/size: Ø 62 h 50 cm
COD. 184 - Misura/size: Ø 52 h 40 cm



ENGLISH

COD. 155

Misura/size: h 65 cm
Piatti/plates: Ø 68 - 48 - 28 cm
Porzioni/portions: 60/70



ENGLISH COLUMN

COD. 158

Misura/size: h 105 cm
Piatti/plates: Ø 68 - 48 - 28 cm
Porzioni/portions: 105/115



CARRÈ

COD. 102

Misura/size: h 96 cm
Piatti/plates: 25 x 25 - 30 x 30 - 35 x 35 -
40 x 40 - 45 x 45 cm
Porzioni/portions: 145/155



CARRÈ

COD. 101

Misura/size: h 120 cm
Piatti/plates: 25 x 25 - 30 x 30 - 35 x 35 -
40 x 40 - 45 x 45 cm
Porzioni/portions: 145/155
FONTANINA non inclusa - not included



CIRCLE

COD. 104

Misura/size: h 86 cm
Piatti/plates: Ø 25 - 30 - 35 - 40 - 48 cm
Porzioni/portions: 100/110



CIRCLE

COD. 103

Misura/size: h 120 cm
Piatti/plates: Ø 25 - 30 - 35 - 40 - 48 cm
Porzioni/portions: 100/110
FONTANINA non inclusa - not included

ACCESSORI - ACCESSORIES



Small column COLONNINA

Misura/size: h 13 cm

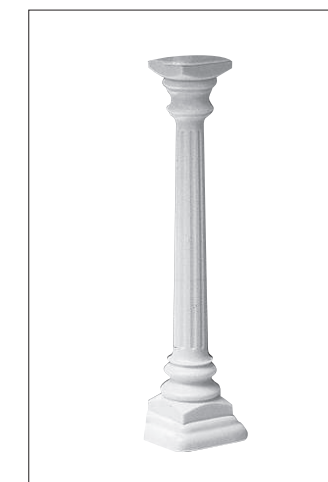

Big column COLONNA

Misura/size: h 35 cm



Electric fountain FONTANINA

Misura/size: Ø 38 h 40 cm



PLASTIC DUMMIES

Tamburi in plastica. Ideali per realizzare wedding cake di grandi dimensioni.
Plastic cake dummies. Ideal for creating large wedding cakes.

Tamburi - Dummies

Size cm	Codice - Code
h 10 - Ø20	40-W110
h 10 - Ø30	40-W111
h 10 - Ø40	40-W112
h 10 - Ø50	40-W113

Set 4 tamburi- Set 4 dummies

40-W106

Misura/size: Ø 50- 40 - 30 - 20 cm



Piatto antiscivolo- Non-slip plate

40-W124

Misura/size: Ø58 cm



Pioli per torta - Cake dowel rods

40PI01

Misura/size: Ø 16 h 300 mm
Pack 12 pcs



Cerchi inox per tamburi St steel rings for dummies

Size cm	Codice - Code
h 5 - Ø19,5	40-W087
h 5 - Ø29,5	40-W088
h 5 - Ø39,5	40-W089
h 5 - Ø49,5	40-W090

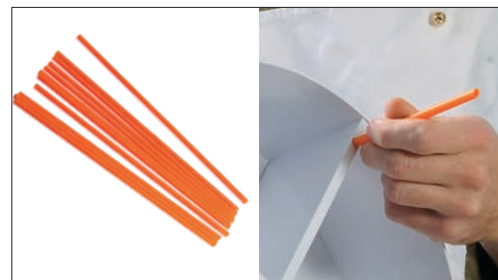

Pioli per torta - Cake dowel rods

40-W101

Misura/size: Ø6 mm
Pack 50 pcs



Kit taglia pioli - Cutter kit

40KIT01

Pioli, seghetto e dima
Plastic dowel rods, hacksaw and support

**Little
Wedding
Cake**



Tonda - Round

COD. 201

Misura/size: Ø 49 h 58 cm
Piatti/plates: Ø 49 - 33 - 17 cm



Ovale - Oval

COD. 202

Misura/size: 51 x 41 h 58 cm
Piatti/plates: 51 x 41 - 35 x 25,5 - 19,5 x 10 cm



Rettangolare - Rectangular

COD. 203

Misura/size: 50 x 41 h 58 cm
Piatti/plates: 50 x 41 - 35 x 25 - 19 x 9 cm



Quadrata - Square

COD. 204

Misura/size: 49 x 49 h 58 cm
Piatti/plates: 49 x 49 - 33 x 33 - 17 x 17 cm

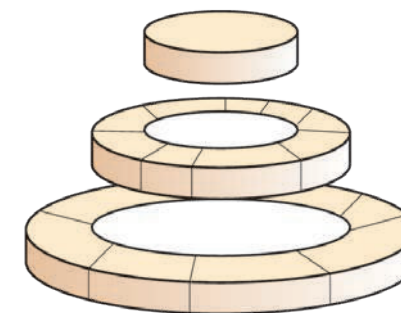

Preparare la base del pan di spugna da sagomare con l'aiuto dei piatti in plastica in dotazione in ogni Little Wedding Cake.
Prepare the sponge cake base to be shaped by using the plastic plates supplied with every Little Wedding Cake.

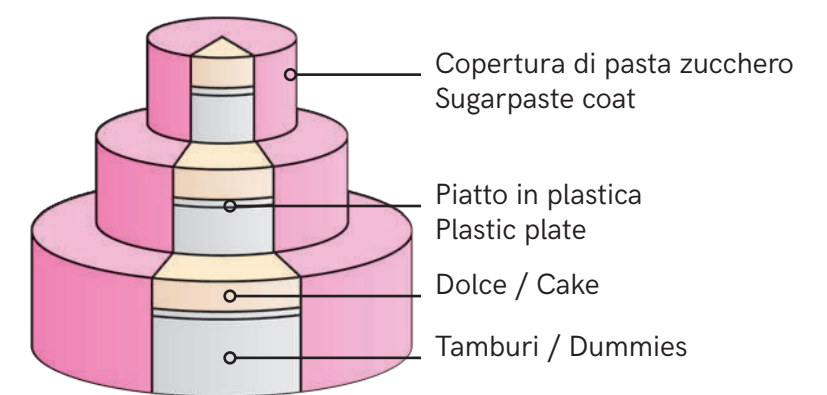

Copertura di pasta zucchero
Sugarpaste coat

Piatto in plastica
Plastic plate

Dolce / Cake

Tamburi / Dummies

MULTIPIANO - MULTI-LEVEL



plastic

metal

Alzate multipiano disponibili nella versione in metallo (METAL) e in resistente plastica bianca (PLASTIC).
Multi level cake stands available in metal version (METAL) or in resistant white plastic (PLASTIC).

Misura Size cm	Porzioni Portions	Piani Levels	Code METAL	Code PLASTIC
Ø 20 - 26 - 32	34-36	3	METAL3	80-2003
Ø 20 - 26 - 32 - 40	60-62	4	METAL4	80-2004
Ø 20 - 26 - 32 - 40 - 45	90-92	5	METAL5	80-2005
Ø 20 - 26 - 32 - 40 - 45 - 50	130-132	6	METAL6	80-2006
Ø 16 - 20 - 26 - 32 - 40 - 45 - 50	175-180	7	METAL7	80-2007
Ø 16 - 20 - 26 - 32 - 40 - 45 - 50 - 55	220-225	8	METAL8	80-2008

MACARON DISPLAYS



I display 80DM02 e 80DM03 sono tra loro impilabili per una maggiore capienza.
The 80DM02 and 80DM03 displays are stackable with each other for greater capacity.



MACARON 24
80DM01 - pack 5 displays
Ø 180 x 175 mm
cap. 24 pcs



MACARON 36
80DM02
Ø 245 x 230 mm
cap. 36 pcs

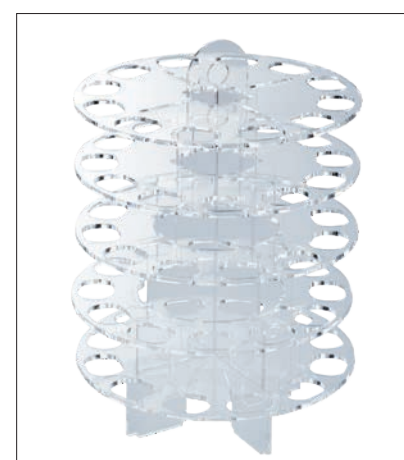

MACARON 60
80DM03
Ø 245 x 355 mm
cap. 60 pcs



AG05701
460 x 330 h 145 mm - 7 file / rows
cap. 70 pcs approx

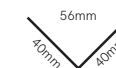

AG05601
270 x 330 h 145 mm - 4 file / rows
cap. 70 pcs approx

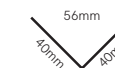

AG05801
315 x 325 h 65 mm - 5 file / rows
cap. 50 pcs approx



AG07901
350 x 350 h 450 mm
cap. 60 pcs

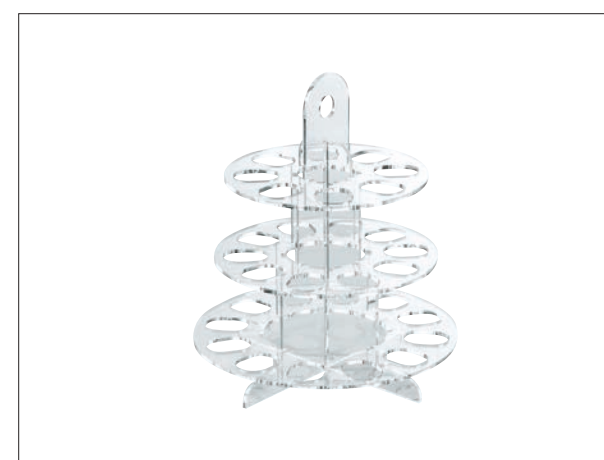

AG07701P
Ø 240 h 280 mm
cap. 30 pcs

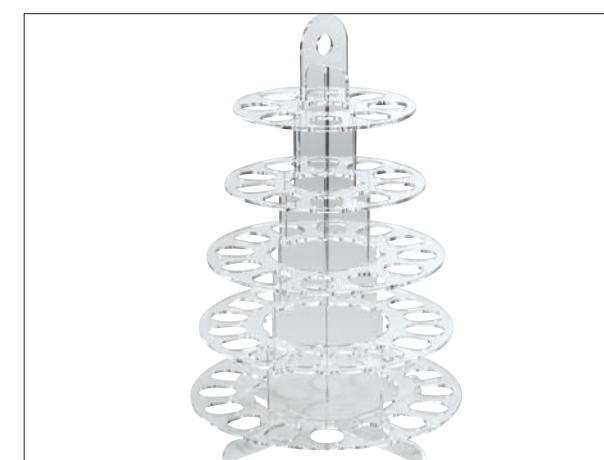

AG07701
Ø 280 h 430 mm
cap. 62 pcs

PLEXIGLASS SHOW CASES



Vetrina porta brioche o macarons
Showcase for croissants or macarons
AG05820 - Trasparente/clear
 Misura/size: 32,5 x 35 h 13 cm
 1 cassetto/drawer
 Kit composto da vetrina, vassoio 30 x 32,5 cm e 5 binari 4 x 4 x 32 cm cad.
 Kit consisting of display case, tray 30 x 32,5 cm and 5 rails 4 x 4 x 32 cm each.



Vetrina con porta - Display with door
 Misura/size: 60 x 36 cm h 16 cm
VP00101 - Trasparente/clear



Vetrina con porta - Display with door
 Misura/size: 49,5 x 37,5 h 52 cm
 2 ripiani/shelves
VB00908 - Nero/black
VB00904 - Rosso/red



Vetrina con porta - Display with door
 Misura/size: 49,5 x 37,5 h 42,5 cm
 3 ripiani inclinati/inclined shelves 39,5 x 27,5 cm
VB00208 - Nero/black
VB00201 - Trasparente/clear



Vetrina a LED con porta - LED display with door
 Misura/size: 39,5 x 32,5 h 50,5 cm
 3 ripiani inclinati/inclined shelves
VB00308 - Nero/black



Vetrina con porta - Display with door
 Misura/size: 31,5 x 30,5 h 45 cm
 3 ripiani/shelves 39,5 x 27,5 cm
VB00804 - Trasparente/clear



Vetrina con porta
Display with door
 Misura/size: 49,5 x 31 h 27 cm
 2 ripiani/shelves -1 lato aperto/
 open side - 2 cassetti/drawers
AR02801 - Trasparente/clear



Vetrina con 2 porte
Display with 2 doors
 Misura/size: 50 x 38 h 45,5 cm
 2 ripiani/shelves
VB00501 - Trasparente/clear



Vetrina con 4 porte
Display with 4 doors
 Misura/size: 60 x 37 h 40 cm
 2 ripiani/shelves
VB00102 - Trasparente/clear



Vetrina con porta - Display with door
 Misura/size: 41 x 36,5 h 44 cm
 3 ripiani inclinati/inclined shelves
VB00306 - Trasparente/clear



Vetrina con porta - Display with door
 Misura/size: 37 x 31 h 31 cm
 3 ripiani inclinati/inclined shelves
VB00408 - Nero/black

PROTEGGI BRIOCHE - FOOD SHIELD

Misure personalizzabili su richiesta - Measures can be changed on request



Proteggi brioche - Plexiglass food shields
AR0001 - 49,5 x 30 h 27 cm
AR00011 - 99,5 x 30 h 27 cm



Proteggi brioche con battuta 4 cm
Plexiglass food shields with 4 cm batting
AR0001B - 49,5 x 30 h 27 cm
AR00011B - 99,5 x 30 h 27 cm



Vassoi bianchi con bordi, ideali per brioche
White trays with edges, ideal for croissants

51VP024510 - 45 x 10 h 2,5 cm
51VP024515 - 45 x 15 h 2,5 cm
51VP024525 - 45 x 25 h 2,5 cm

51VP026010 - 60 x 10 h 2,5 cm
51VP026015 - 60 x 15 h 2,5 cm
51VP026025 - 60 x 25 h 2,5 cm

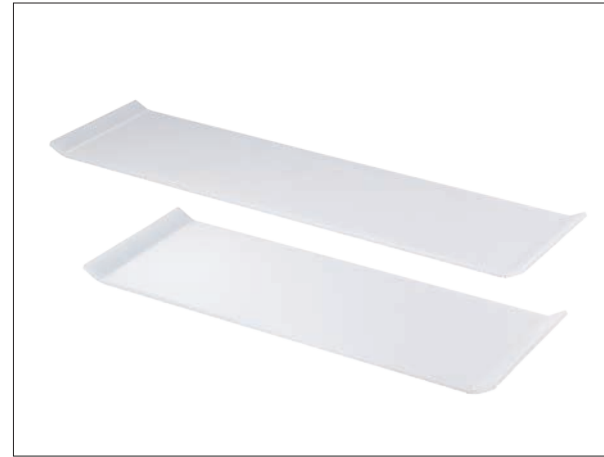

Vassoi bianchi piani, ideali per monoporzioni,
mignon e pralineria / White flat trays, ideal for
monoportions, mignon and pralines

51VP014510 - 45 x 10 cm
51VP014515 - 45 x 15 cm
51VP014525 - 45 x 25 cm

51VP016010 - 60 x 10 cm
51VP016015 - 60 x 15 cm
51VP016025 - 60 x 25 cm

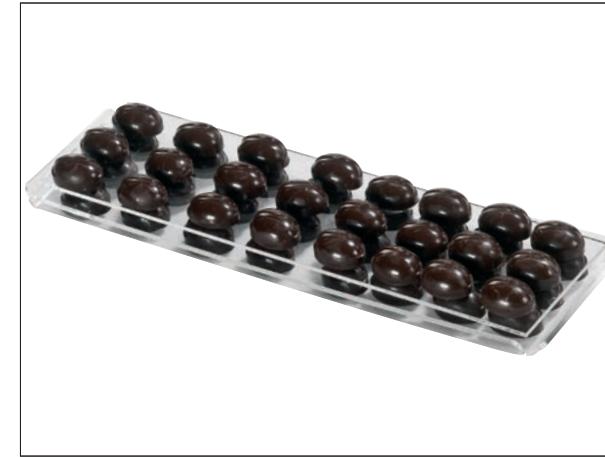

Vassoio per vetrina con bordi
Display tray with edges

VP00401 - 34 x 11 h 2 cm

Piatto per vetrina
Display plate

VP00501 - 32 x 9 h 0,2 cm



Vassoio per vetrina con bordi
Display tray with edges

VP00906 - 10 x 50 h 2 cm

Piatto per vetrina
Display plate

VP01001 - 9,5 x 49,5 h 0,2 cm



Vassoio per vetrina con bordi - bianco
Display tray with edges - white

VP00500 - 32 x 20 h 2,5 cm
VP00700 - 18 x 29 h 2,5 cm
50VP00402 - 14 x 40 h 2 cm

Piatto per vetrina - trasparente
Display plate - clear

VP00601 - 26 x 15 h 0,2 cm
VP00801 - 13 x 24 h 0,2 cm

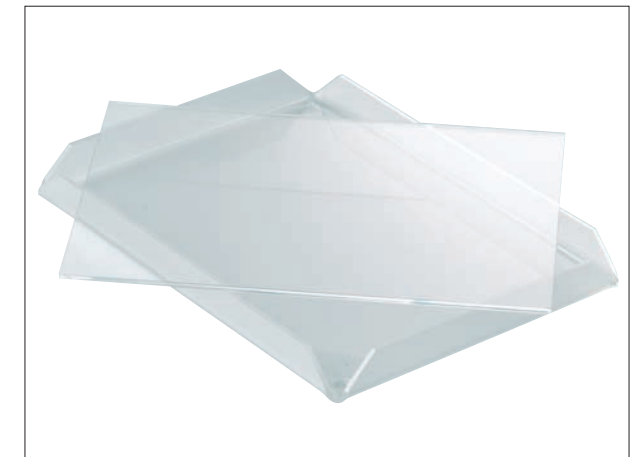

Vassoio per vetrina con bordi - satinato
Display tray with edges - glazed

VP01106 - 17 x 23 h 2 cm
VP00206 - 17 x 17 h 2 cm

Piatto per vetrina - trasparente
Display plate - clear

VP01201 - 16,5 x 22,5 h 0,2 cm
VP00301 - 16,5 x 16,5 h 0,2 cm

Stampi in speciale materiale plastico per realizzare splendide sculture in ghiaccio.
Moulds made of special plastic to create spectacular ice sculptures.



Vassoi neri con bordi / Black trays with edges

- 50VP0508 - 14,5 x 40 h 2 cm
- 50VP0608 - 14,5 x 28,9 h 2 cm
- 50VP0708 - 20,4 x 25,8 h 2 cm
- 50VP0808 - 29,4 x 39,4 h 2 cm



Vassoi bianchi con bordi / White trays with edges

- 50VP0500 - 14,5 x 40 h 2 cm
- 50VP0600 - 14,5 x 28,9 h 2 cm
- 50VP0700 - 20,4 x 25,8 h 2 cm
- 50VP0800 - 29,4 x 39,4 h 2 cm



Vassoi neri piani quadrati, spessore 5 mm
Black flat square trays, thickness 5 mm

- 50VP202008 - 20 x 20 cm
- 50VP252508 - 25 x 25 cm

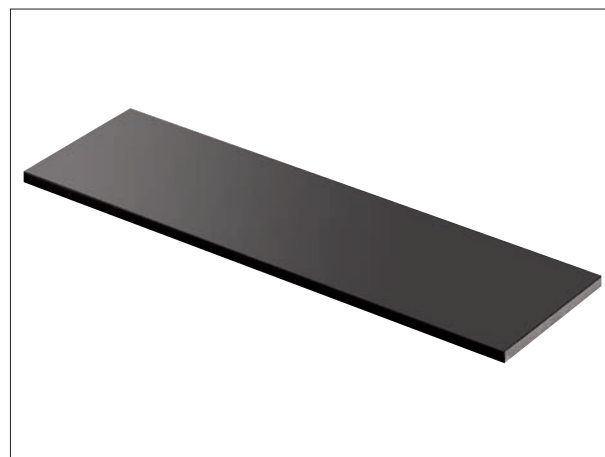

Vassoi neri piani rettngolari, spessore 5 mm
Black flat rectangular trays, thickness 5 mm

- 50VP201008 - 20 x 10 cm
- 50VP251208 - 25 x 12 cm
- 50VP601008 - 60 x 10 cm
- 50VP602508 - 60 x 25 cm



Su richiesta ampia gamma di colori e misure
On request different colors and sizes



MIR01

scultura/sculpture: 42 x 26 h 53 cm
stampo/mould: 60 x 25 h 65 cm - 7 kg



MIR08

scultura/sculpture: 58 x 25 h 56 cm
stampo/mould: 69 x 25 h 70 cm - 8 kg



MIR07

scultura/sculpture: 41 x 41 h 83 cm
stampo/mould: 51 x 41 h 96 cm - 9 kg



MIR17

scultura/sculpture: Ø 39 h 15 cm
stampo/mould: Ø 53 h 19 cm - 4,5 kg



MIR16

scultura/sculpture: Ø 40 h 20 cm
stampo/mould: Ø 52 h 23 cm - 4 kg



MIR05

scultura/sculpture: 36 x 26 h 67 cm
stampo/mould: 50 x 26 h 78 cm - 7,5 kg

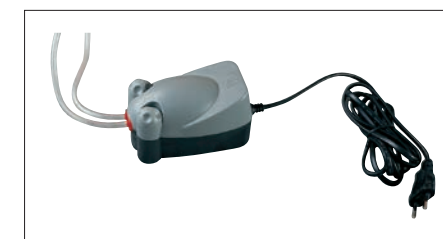

MIP - pompetta/pump

La pompetta tiene in movimento l'acqua all'interno dello stampo durante il processo di congelazione e la scultura di ghiaccio risulterà più trasparente.

The air pump makes the water circulate inside the mould during the process of freezing and the ice sculpture will be more transparent.

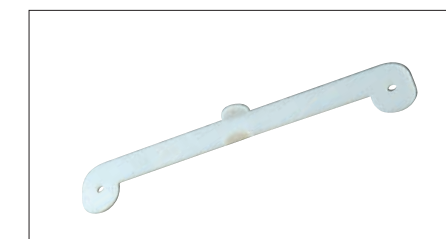

Supporto per pompetta
Air pump support

MIS05 - per MIR05
MIS08 - per MIR08

CREATIVE COLORS

Velvet SPRAY

Spray a base di burro di cacao che dona un effetto vellutato. L'articolo deve essere spruzzato su tutte le superfici fredde come gelato, semifreddi, mousse e cioccolato, perchè il burro di cacao cristallizzi creando l'effetto desiderato.

Spray cocoa butter with a velvety effect. The article can be sprayed on all cold surfaces such as ice cream, semifreddo, mousse and chocolate.



WHITE
40LCV000
400 ML

GLUTEN FREE
E171 FREE
APPROVED FDA
ASO FREE

ORANGE
40LCV001
400 ML

GLUTEN FREE
E171 FREE

SKY BLUE
40LCV003
400 ML

GLUTEN FREE
E171 FREE
ASO FREE

YELLOW
40LCV004
400 ML

GLUTEN FREE
E171 FREE
ASO FREE

MILK CHOCOLATE
40LCV005
400 ML

GLUTEN FREE
E171 FREE

BLACK
40LCV006
400 ML

GLUTEN FREE
E171 FREE

PINK
40LCV007
400 ML

GLUTEN FREE
E171 FREE
APPROVED FDA
ASO FREE

RED
40LCV008
400 ML

GLUTEN FREE
E171 FREE
APPROVED FDA
ASO FREE

GREEN
40LCV009
400 ML

GLUTEN FREE
E171 FREE
ASO FREE

LILAC
40LCV010
400 ML

GLUTEN FREE
E171 FREE
APPROVED FDA
ASO FREE

BLACK CHERRY RED
40LCV013
400 ML

GLUTEN FREE
E171 FREE

DARK CHOCOLATE
40LCV015
400 ML

GLUTEN FREE
E171 FREE

WHITE CHOCOLATE
40LCV024
400 ML

GLUTEN FREE
E171 FREE
ASO FREE

FUCHSIA
40LCV027
400 ML

GLUTEN FREE
E171 FREE
APPROVED FDA
ASO FREE

COLOR DUST

WATER-SOLUBLE

Food Coloring Powder



Colorante in polvere idrosolubile ideale per la colorazione in massa di prodotti a base acqua quali isomalto, zucchero, panna, meringhe, macarons ed altre preparazioni.

Water-soluble powder ideal to mass colouring water-based products like isomalt, sugar, cream, meringue, macarons and other.

GLUTEN FREE
BLACK
40LCP206 25 GR



GLUTEN FREE
RED
40LCP208 25 GR



GLUTEN FREE
GREEN
40LCP209 25 GR



GLUTEN FREE
ORANGE
40LCP211 25 GR



GLUTEN FREE
STRAWBERRY RED
40LCP218 25 GR



GLUTEN FREE
TURQUOISE
40LCP226 25 GR



COLOR DUST

LIPOSOLUBLE

Food Coloring Powder



Colorante in polvere liposolubile adatto alla colorazione in massa di prodotti a base grassa quali cioccolato, crema al burro, pasta di mandorle, pasta da zucchero, semifreddi.

Può essere utilizzato in superficie con un pennello tal quale o diluito con la nostra gommalacca liquida per ottenere un prodotto per la decorazione a pennello.

Fat-soluble powder colour appropriate for in mass colouring of fat based products like chocolate, butter cream, almond paste, sugar paste, semifreddo. You could use it as such on product surface using a brush or you can dilute it using our liquid shiny obtaining a product for decoration by brush.

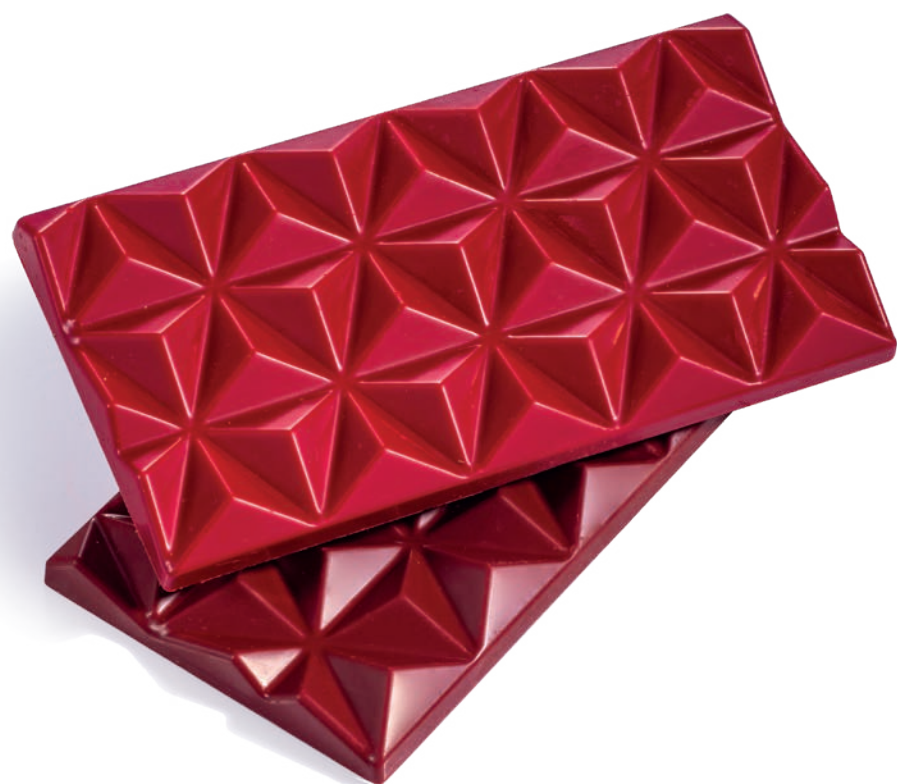

PEARL

PEARL COBALT
40LCP002 25 GR
E171 FREE 40WC002 5 GR

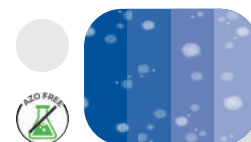

PEARL BRONZE
40LCP015 25 GR
E171 FREE 40WC015 5 GR

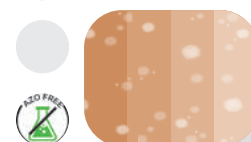

PEARL GOLD
40LCP017 25 GR
E171 FREE 40WC017 5 GR

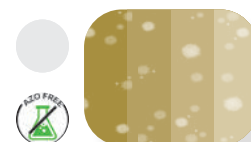

DARK PEARL SILVER
40LCP019 25 GR
E171 FREE 40WC019 5 GR

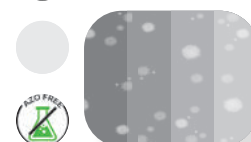

LIGHT PEARL SILVER
40LCP119 25 GR
E171 FREE 40WC119 5 GR



PEARL VIOLET
40LCP010 25 GR
E171 FREE 40WC010 5 GR



PEARL LIME GREEN
40LCP016 25 GR
E171 FREE 40WC016 5 GR

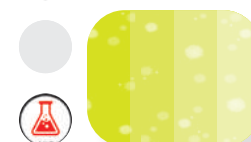

PEARL RUBY
40LCP018 25 GR
E171 FREE 40WC018 5 GR



PEARL COPPER
40LCP020 25 GR
E171 FREE 40WC020 5 GR

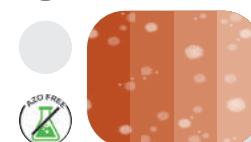

PASTEL

WHITE
40LCP300 25 GR
E171 FREE



YELLOW
40LCP304 25 GR
E171 FREE 40WC304 5 GR



BLACK
40LCP306 25 GR
E171 FREE 40WC306 5 GR



RED
40LCP308 25 GR
E171 FREE 40WC308 5 GR



GREEN
40LCP309 25 GR
E171 FREE 40WC309 5 GR



TURQUOISE
40LCP326 25 GR
E171 FREE 40WC326 5 GR



BLUE
40LCP302 25 GR
E171 FREE 40WC302 5 GR



BROWN
40LCP305 20 GR
E171 FREE 40WC305 5 GR



PINK
40LCP307 25 GR
E171 FREE 40WC307 5 GR



SHOCK RED
40LCP308N 25 GR
E171 FREE 40WC308N 5 GR



ORANGE
40LCP311 25 GR
E171 FREE 40WC311 5 GR



Natural COLOR



Colorante alimentare naturale in polvere idrosolubile ideale per la decorazione e colorazione di meringhe, macaron, glasse e molto altro.

Water-soluble natural food coloring powder ideal for the decoration and coloring of meringues, macaron, glaze and much more.



 BLUE
40LCPN202 25 GR



 YELLOW
40LCPN204 25 GR



 BLACK
40LCPN206 25 GR



 RED
40LCPN208 25 GR



 GREEN
40LCPN209 25 GR



Natural COLOR



Colorante alimentare naturale in polvere liposolubile adatto alla colorazione in massa di prodotti a base grassa quali cioccolato, crema al burro, pasta di mandorle, pasta da zucchero, semifreddi.

Edible natural dye. Liposoluble powder colour suitable for the mass coloring of fat-based products such as chocolate, butter cream, almond paste, sugar paste, semifreddo.

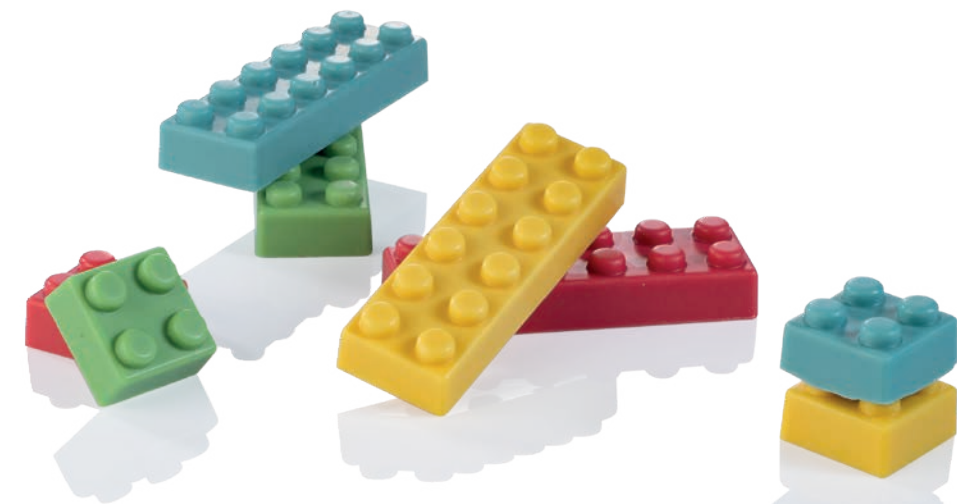

 BLUE
40LCPN302 25 GR



 YELLOW
40LCPN304 25 GR



 PINK
40LCPN307 25 GR



 RED
40LCPN308 25 GR



 GREEN
40LCPN309 25 GR



 VIOLET
40LCPN310 25 GR



Metal DUST

Colorante in fine polvere con effetto perlato ideale per decorare prodotti finiti, presentato con speciale packaging spray non pressurizzato.

Soft powder colour with a pearly effect in a special non-pressurized spray packaging.



 SPARKLING PEARL RED

 **40LCP508**
10 GR



 SPARKLING PEARL CHERRY RED

 **40LCP513**
10 GR



 SPARKLING PEARL BRONZE

 **40LCP515**
8 GR

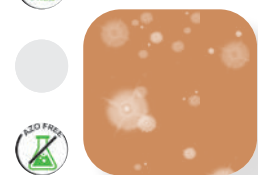

 SPARKLING PEARL GOLD

 **40LCP517**
10 GR

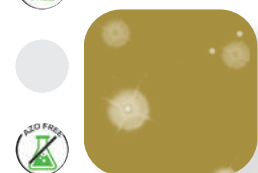

 SPARKLING PEARL SILVER

 **40LCP519**
10 GR



 SPARKLING PEARL COPPER

 **40LCP520**
10 GR

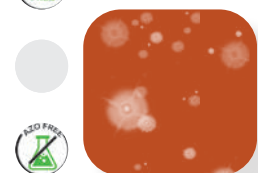

DRIP Top

Prodotto di facile utilizzo per decorare tramite la tecnica del dripping torte, semifreddi, gelati e molto altro.

Product easy to use to decorate cakes using the dripping technique, frozen desserts, ice cream and much more.



 BLUE
40LCD003
180 GR



 CHOCOLATE
40LCD005
180 GR



 PINK
40LCD007
180 GR



 CHERRY RED
40LCD008
180 GR



 WHITE CHOCOLATE
40LCD024
180 GR



color SMART



Spray colorati idroalcolici ideali per decorare torte a base di panna, piccole decorazioni di cioccolato, prodotti di pasticceria come biscotti, wafer, cialde e dolci a base di pasta di zucchero.

Colored hydroalcoholic sprays ideal for decorating cream-based cakes, small chocolate decorations, pastry products such as biscuits, wafers, waffles and sugar paste covered cakes.

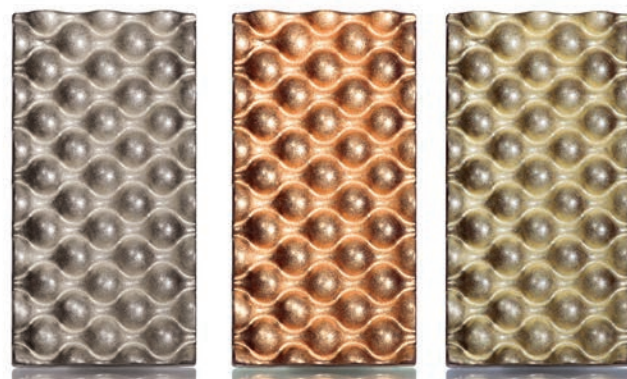



PEARL

 PEARL MOTHER OF PEARL
40LCS200 100 ML

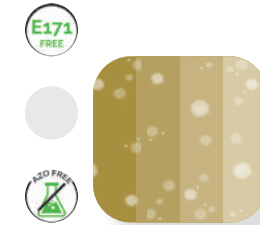

 PEARL GOLD
40LCS217 100 ML



 PEARL SILVER
40LCS219 100 ML



 PEARL BRONZE
40LCS215 100 ML

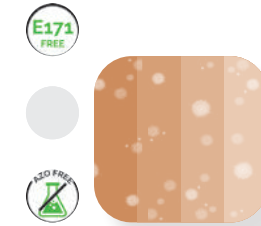

 PEARL RUBY
40LCS218 100 ML

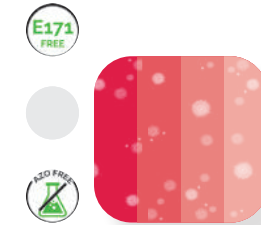

 PEARL COPPER
40LCS220 100 ML

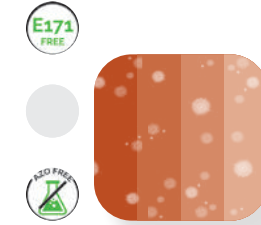

PASTEL

 WHITE
40LCS000 100 ML



 YELLOW
40LCS004 100 ML



 PINK
40LCS007 100 ML



 GREEN
40LCS009 100 ML

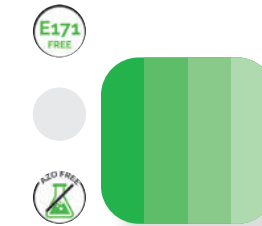

 ORANGE
40LCS001 100 ML



 BROWN
40LCS005 100 ML

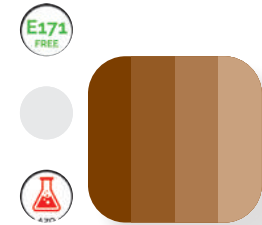

 RED
40LCS008 100 ML





Colorante in gel idrosolubile molto concentrato nato per la colorazione in massa di tutti i prodotti a base acqua o emulsioni come pasta di zucchero, panna, crema al burro, glassa, impasti vari quali biscotti meringhe e torte.

Very concentrated water-soluble gel colour created for the mass coloring of all water-based products or emulsions such as sugar paste, cream, butter cream, icing, various doughs such as meringue biscuits and cakes.



GLUTEN FREE
ORANGE
40LCG001 30 GR



GLUTEN FREE
BLUE
40LCG002 30 GR



GLUTEN FREE
YELLOW
40LCG004 30 GR



GLUTEN FREE
BROWN
40LCG005 30 GR



GLUTEN FREE
BLACK
40LCG006 30 GR

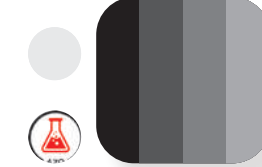

GLUTEN FREE
PINK
40LCG007 30 GR



GLUTEN FREE
RED
40LCG008 30 GR



GLUTEN FREE
GREEN
40LCG009 30 GR



GLUTEN FREE
VIOLET
40LCG010 30 GR



GLUTEN FREE
LIME GREEN
40LCG016 30 GR



GLUTEN FREE
TURQUOISE
40LCG026 30 GR



EASY COLOR



Colorante liquido pronto all'uso, pensato per assicurare una nebulizzazione perfetta ed omogenea sulla superficie di torte e dolci attraverso l'utilizzo di aerografi.

Grazie alla sua formula idrosolubile, è ideale anche per la colorazione in massa di pan di spagna, panna, crema, gelatina, pasta di mandorle, marzipane e bevande in genere.

Ready-to-use liquid colour, designed to ensure a perfect and homogeneous nebulization on the surface of cakes and sweets through the use of airbrushes.

Thanks to its water-soluble formula, it is also ideal for the mass coloring of sponge cake cream, cream, jelly, almond paste, marzipan and drinks in general.



GLUTEN FREE
ORANGE
40LCA001 190 ML



GLUTEN FREE
BLUE
40LCA002 190 ML

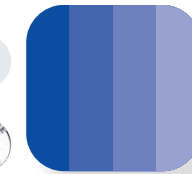

GLUTEN FREE
SKY BLUE
40LCA003 190 ML



GLUTEN FREE
YELLOW
40LCA004 190 ML



GLUTEN FREE
BROWN
40LCA005 190 ML

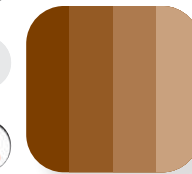

GLUTEN FREE
BLACK
40LCA006 190 ML

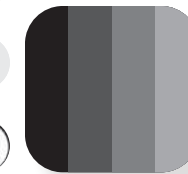

GLUTEN FREE
PINK
40LCA007 190 ML



GLUTEN FREE
RED
40LCA008 190 ML



GLUTEN FREE
GREEN
40LCA009 190 ML



GLUTEN FREE
VIOLET
40LCA010 190 ML

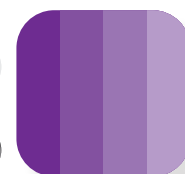

GLUTEN FREE
LEMON YELLOW
40LCA011 190 ML



GLUTEN FREE
LIGHT GREEN
40LCA012 190 ML



GLUTEN FREE
PEARL MOTHER OF PEARL
40LCA400 100 ML



CHOCOLOR

Food Coloring Cocoa Butter



Burro di cacao colorato, ideale per la colorazione e decorazione di cioccolato e masse grasse.

Coloured cocoa butter, perfect to colour and decorate chocolate and fat masses.



GLUTEN FREE
WHITE
40LCB000 200 GR



GLUTEN FREE
ORANGE
40LCB001 200 GR



GLUTEN FREE
BLUE
40LCB002 200 GR



GLUTEN FREE
YELLOW
40LCB004 200 GR

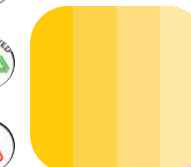

GLUTEN FREE
BLACK
40LCB006 200 GR



GLUTEN FREE
RED
40LCB008 200 GR

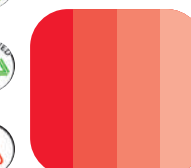

GLUTEN FREE
GREEN
40LCB009 200 GR



GLUTEN FREE
GOLD
40LCB017 200 GR

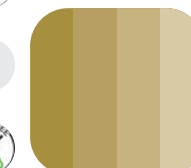

GLUTEN FREE
SILVER
40LCB019 200 GR



Butter SPRAY

40LCV100
400 ML



Lucidante alimentare neutro a base di burro di cacao ideale per proteggere e lucidare marzapane e pasta di mandorle.

Neutral food polish made of cocoa butter ideal for protecting and polishing marzipan and almond paste.

Shiny SPRAY

40LCS201
300 ML



Gommalacca spray ideale per lucidare e proteggere superfici a base di zucchero e cioccolato.

Shellac spray ideal for polishing and protecting sugar and chocolate surfaces.

Baking SPRAY

COATING
400 ML



Staccante alimentare per velocizzare la rimozione del prodotto da teglie in acciaio e alluminio, stampi, termoformati o altro. Inodore e insapore.

Ideal food release agent to speed up the removal of the product from steel and aluminium trays, moulds, thermoformed or other. Odorless and tasteless.

Cooling SPRAY

EUROCHOCK
400 ML



Refrigerante spray per raffreddamento istantaneo di prodotti a base di zucchero o cioccolato durante la lavorazione artistica.

Spray cooler for instant chilling of sugar or chocolate products during the artistic processing.

JELLIES

Gelatina alimentare ideale per guarnire torte e prodotti di pasticceria in genere, può essere colorata con i gel color e con le polveri idrosolubili.

Food-grade gelatine ideal for garnishing cakes and pastry products in general, it can be coloured with colourant gels and water-soluble powders.



JELLIES - FOOD JELLY
40LCJ000
1 KG



GLUE

Colla alimentare per la creazione di soggetti in pasta di zucchero e cialda.

Food glue for the creation of sugar paste and wafer subjects.



GLUE - FOOD GLUE
40W166
25 GR



CMC

Additivo alimentare utilizzato come addensante. Aggiungendolo alla pasta zucchero si ottiene una pasta più resistente e più facile da modellare.

Food additive used as thickener. By adding it to the sugar paste it produces a more resistant and easier to shape paste.



CMC - THICKENER FOR SUGAR
40W042
40 GR



SPECIAL EQUIPMENT

EASY SYSTEM

CHITARRE - GUITARS



Nuova maniglia arrotondata per una comoda impugnatura

New rounded handle for a comfortable grip

Elementi in resistente materiale plastico

Resistant plastic elements

Filo sostituibile singolarmente

Individually replaceable wire

Sistema ad incastro

Interlocking system

Misura di taglio su ogni telaio

Cutting size on each frame

Telai universali in acciaio inox smontabili per agevolare le operazioni di pulizia e manutenzione

Universal stainless steel removable frames to facilitate cleaning and maintenance

La chitarra è lo strumento ideale per tagliare in modo preciso cremini, ganache, gelatine, mignon e masse morbide.

La base di taglio è realizzata in resistente materiale plastico, i telai sono in acciaio inox e i fili intercambiabili singolarmente. La chitarra è composta da una solida base in plastica e da telai di diverse misure, fornibili separatamente in base alle esigenze del singolo operatore, oltre ad essere predisposta per il taglio e il calibro di grandi quantità di prodotti in modo preciso e privo di imperfezioni. Nella confezione delle basi sono presenti: 1 piatto in acciaio inox - 1 racla PST - 3 fili di ricambio - 2 chiavi per il fissaggio fili.

The guitar is the ideal tool for cutting cremini, ganache, jellies, mignons and soft masses precisely.

The cutting base is made of strong plastic material, the frames are made of stainless steel and the wires are individually interchangeable. The guitar consists of a solid plastic base and frames of different sizes, which can be supplied separately according to the needs of the individual operator, as well as being predisposed for cutting and calibrating large quantities of products precisely and without imperfections. In the packaging of the bases there are: 1 stainless steel plate - 1 plastic spatula - 3 spare wires - 2 keys for fixing wires.

EASY SYSTEM

Il sistema ad incastro facilita l'inserimento ed il cambio dei telai, riducendo i tempi di montaggio, smontaggio e manutenzione.
The interlocking system makes it easier to insert and change frames, reducing assembly, disassembly and maintenance time.

DOUBLE

La chitarra doppia permette di tagliare rapidamente il prodotto in un unico passaggio.
Ideale per produrre perfetti quadrati e rettangoli di diverse dimensioni.

The double guitar allows you to quickly cut the product in a single operation.
Ideal for producing perfect squares and rectangles of different sizes.

50-CD100N

PIANO DI TAGLIO
CUTTING SURFACE

36X35CM

TELAI NON INCLUSI.
FRAMES NOT INCLUDED.



Telaio base in alluminio
Aluminum base frame

SINGLE

50-CS100

PIANO DI TAGLIO
CUTTING SURFACE

36X42CM

TELAI NON INCLUSI.
FRAMES NOT INCLUDED.

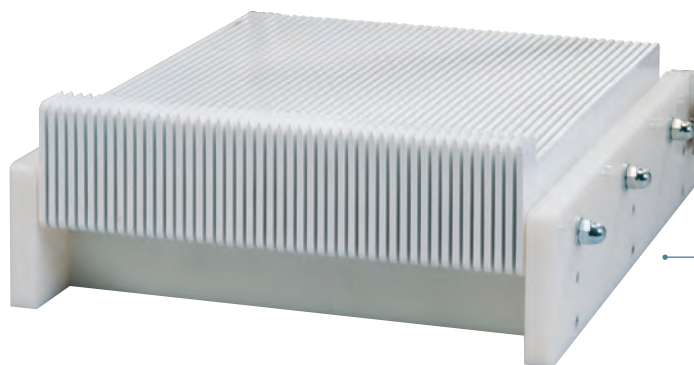

Base in polietilene
Polyethylene base

TELAI - FRAMES

Maniglia arrotondata per una comoda impugnatura
Rounded handle for a comfortable grip

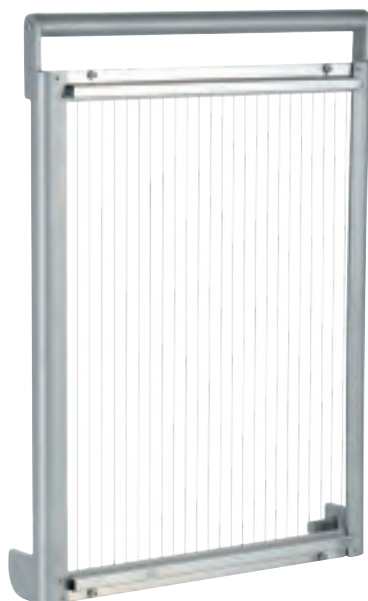

Misura-Size: 615x427 mm

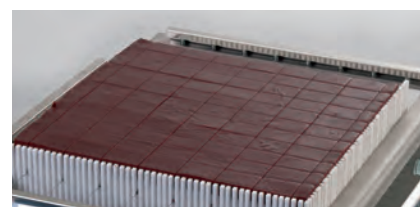

I telai sono intercambiabili e **adatti ad entrambe le basi** sia per il taglio frontale che laterale tranne il telaio da 15 mm, predisposto **solo al taglio frontale**.

The frames are interchangeable, and **suitable for both bases** for both front and side cutting except the 15mm which cannot be used **only for frontal cutting**.

15 mm

50-C015
solo taglio frontale
only for frontal
cutting

22 mm

50-C022
intercambiabile
interchangeable

30 mm

50-C030
intercambiabile
interchangeable

45 mm

50-C045
intercambiabile
interchangeable

Parti ricambio - Spare parts

Piatto Inox
Steel Sheet
CHITRIC 6/D

Spatola
Spatula
SPB

Chiavi fissaggio
Special Spanner

Filo Inox
Inox wire
CHITRIC 9
1 pc

Viti e Dadi
Bolts and Nuts
CHITRIC 10
2+2 pcs

CHITARRE MINI GUITARS

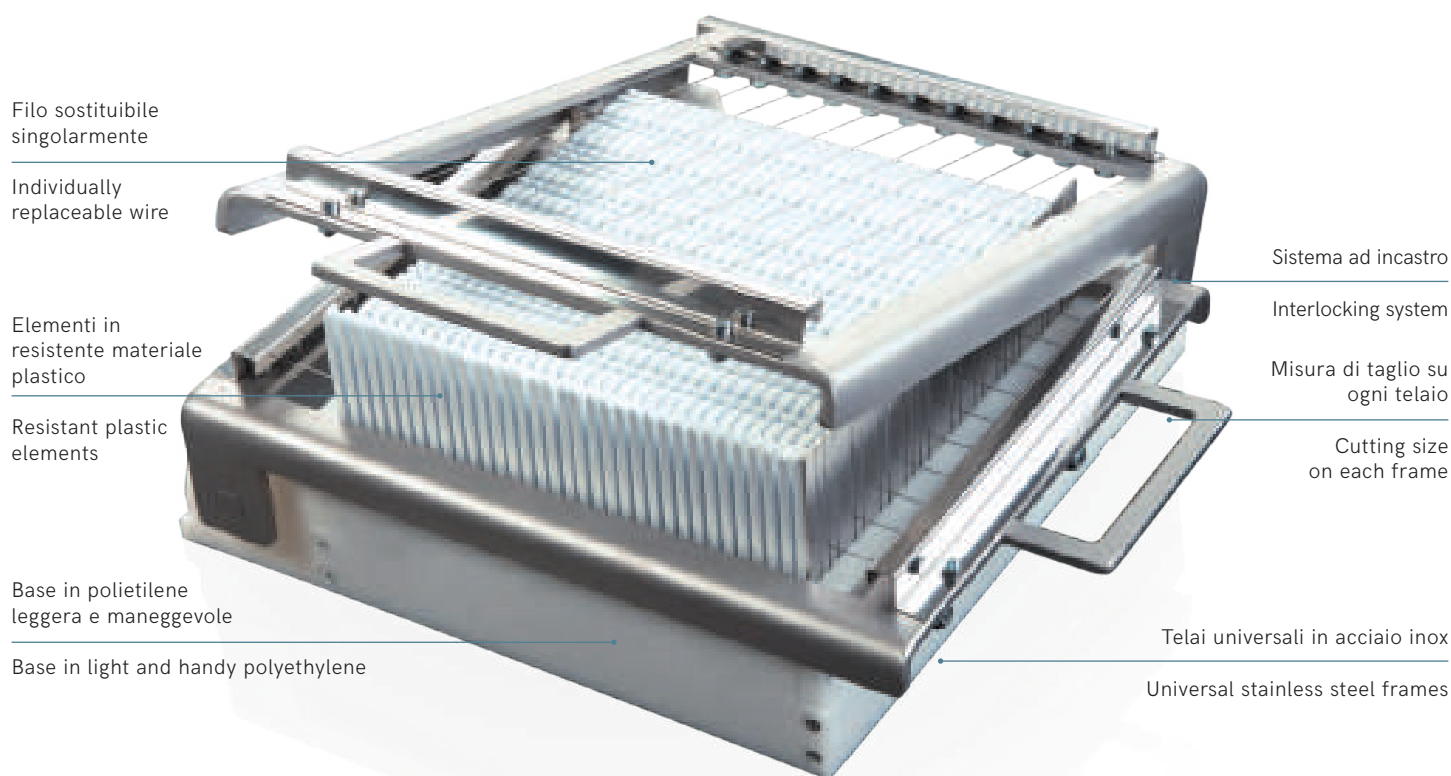

La MiniChitarra, ideale per ristoranti, gelaterie e cioccolaterie, è adatta a piccole produzioni di prodotti dolciari. Grazie alle dimensioni contenute può essere facilmente riposta anche in piccoli spazi e utilizzata all'occorrenza. Inclusi nella confezione: 1 piatto inox - 1 racla PST - 3 fili di ricambio - 2 chiavi per il fissaggio fili.

The Mini Guitar, ideal for restaurants, ice-cream and chocolate shops, is suitable for small productions of confectionery products. Thanks to its small size it can be easily stored even in small spaces and used when necessary. Included in the package: 1 stainless steel plate - 1 plastic spatula - 3 spare wires - 2 keys for wire fixing.

SINGLE

PIANO DI TAGLIO
CUTTING SURFACE

25X28CM

1 TELAIO INCLUSO.
1 FRAME INCLUDED.

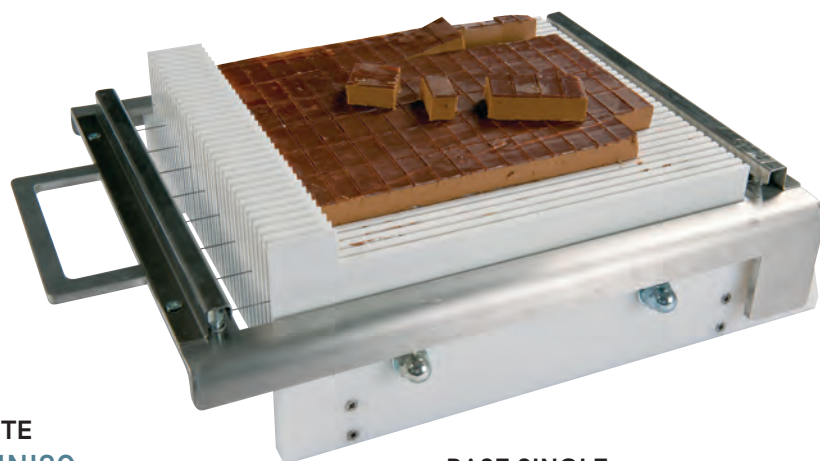

**COMPLETE
CHITMINI15**
con 1 telaio 15 mm
with 1 frame 15 mm

**COMPLETE
CHITMINI**
con 1 telai 22 mm
with 1 frame 22 mm

**COMPLETE
CHITMINI30**
con 1 telai 30 mm
with 1 frame 30 mm

**BASE SINGLE
CHITBA24**
Base - senza telai
Base - without frames

DOUBLE

La chitarra doppia permette di tagliare rapidamente il prodotto in un unico passaggio. Ideale per produrre perfetti quadrati e rettangoli di dimensioni differenti. Telai smontabili per agevolare le operazioni di pulizia e manutenzione.

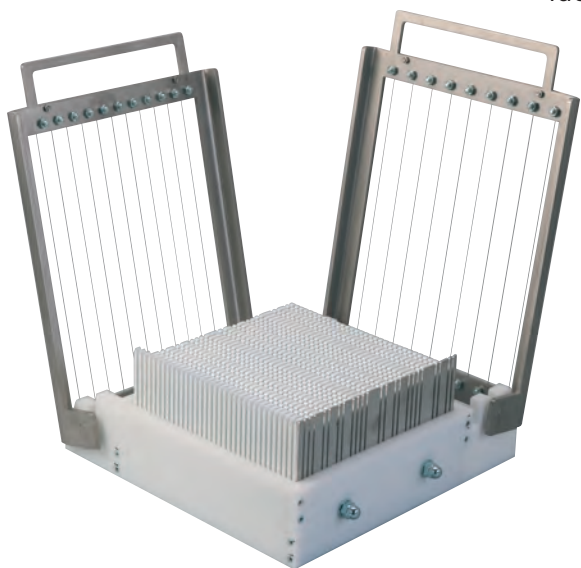

The double guitar allows you to quickly cut the product in one step. Ideal for producing perfect squares and rectangles of different sizes. Removable frames to facilitate cleaning and maintenance.



PIANO DI TAGLIO
CUTTING SURFACE

24X25CM

2 TELAI INCLUSI

2 FRAMES INCLUDED

COMPLETE
CHITMINID22
con 2 telai da 22 mm
with 2 frames 22 mm

COMPLETE
CHITMINID30
con 2 telai da 30 mm
with 2 frames 30 mm

BASE DOUBLE
CHITBAD24
Base - senza telai
Base - without frames

TELAI - FRAMES



Misura-Size: 443x314 mm

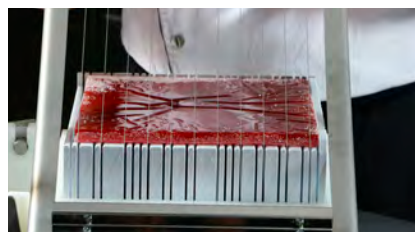

I telai sono intercambiabili e adatti ad **entrambe le basi**, sia per il taglio frontale che laterale. Fatta eccezione per il telaio da 15 mm, predisposto **solo al taglio frontale**.

The frames are interchangeable and **suitable for both bases**, both for front and side cutting. Except for the 15 mm frame, which is **only suitable for frontal cutting**.

15 mm
CHIT15
solo taglio frontale
only for frontal
cutting

22,5 mm
CHIT22
intercambiabile
interchangeable

30 mm
CHIT30
intercambiabile
interchangeable

Parti ricambio - Spare parts

Piatto Inox
St. steel Sheet
CHITP

Spatola
Spatula
SPBMINI

Chiavi Fissaggio
Special Spanner
CHITRIC 8
2 pcs

Filo Inox
Inox wire
CHITRIC 9
1 pc

Viti e Dadi
Bolts and Nuts
CHITRIC 10
2+2 pcs

Classic DOUBLE



La chitarra doppia permette di tagliare rapidamente il prodotto in un unico passaggio.
Ideale per produrre perfetti quadrati e rettangoli di dimensioni differenti.
Telai smontabili per agevolare le operazioni di pulizia e manutenzione.

The double guitar allows you to quickly cut the product in one step.
Ideal for producing perfect squares and rectangles of different sizes.
Removable frames to facilitate cleaning and maintenance.

Inclusi nella confezione : 1 piatto inox - 1 racla PST - 2 chiavi per il fissaggio fili - 2 dadi.
Included in the package: 1 stainless steel plate - 1 plastic spatula - 2 keys for wire fixing - 2 nuts



CHITDOUBLE
PIANO DI TAGLIO
CUTTING SURFACE

38X42CM

4 TELAI INCLUSI.*
4 FRAMES INCLUDED.*

BASE DOUBLE
CHITRIC 5/D

solo base - senza telai
only base - without frames
58,5x48 h15,5 cm

TELAI - FRAMES

I telai non sono intercambiabili:
i telai da 20 e da 30 mm, predisposti **solo al taglio laterale**.
The frames are not interchangeable:
the 20 and 30 mm, which cannot be used **only for side cutting**.

* 22,5 mm

CHITRIC 2/D

SOLO FRONTALE - Incluso nel kit
ONLY FRONT - Included in kit

* 30 mm

CHITRIC 3/D

SOLO FRONTALE - Incluso nel kit
ONLY FRONT - Included in kit

* 45 mm

CHITRIC 4/D

SOLO FRONTALE - Incluso nel kit
ONLY FRONT - Included in kit

* 30 mm

CHITRIC 1/LD

SOLO LATERALE - Incluso nel kit
ONLY SIDE - Included in kit

15 mm

CHITRIC 1/D

SOLO FRONTALE - Non incluso nel kit
ONLY FRONT - Not included in kit

20 mm

CHITRIC 2/LD

SOLO LATERALE - Non Incluso
ONLY SIDE - Not included

Classic SINGLE



La chitarra è lo strumento ideale per tagliare in modo preciso cremini, ganache, gelatine, mignon e masse morbide. Base di taglio realizzata in resistente materiale plastico, telai in acciaio inox e fili intercambiabili singolarmente.

The guitar is the ideal tool to precisely cut cremini, ganache, fruit jellies, mignon and soft food. Cutting base made of durable plastic material, stainless steel frames and interchangeable wires individually.

Inclusi nella confezione : 1 piatto inox - 1 racla PST - 2 chiavi per il fissaggio fili - 2 dadi.
Included in the package: 1 stainless steel plate - 1 plastic spatula - 2 keys for wire fixing - 2 nuts



CHITCOMP
PIANO DI TAGLIO
CUTTING SURFACE

36X41CM

3 TELAI INCLUSI.*
3 FRAMES INCLUDED.*



BASE SINGLE
CHITRIC 5

solo base - senza telai
only base - without frames
50x44 h15,5 cm

TELAI - FRAMES

* 22,5 mm

CHITRIC 2

Incluso nel kit - Included in kit

* 30 mm

CHITRIC 3

Incluso nel kit - Included in kit

* 45 mm

CHITRIC 4

Incluso nel kit - Included in kit

15 mm

CHITRIC 1

Non Incluso
Not included

Parti ricambio - Spare parts

Adatti ad entrambi i modelli (DOUBLE e SINGLE)
Suitable for each model (DOUBLE and SINGLE)

Piatto Inox
Steel Sheet
CHITRIC 6/D

Spatola
Spatula
SPB

Viti e Dadi
Strings and Nuts
CHITRIC 10

Chiavi di Fissaggio
Spanners
CHITRIC 8

Filo Inox
Inox wire
CHITRIC 9

CHITARRE A SPINTA DRIVING-FORCE GUITARS

Ideale per tagliare cremeni e ganache con frutta secca o prodotti duri e piccola pasticceria anche a bassa temperatura. L'avanzamento del piano di lavoro avviene manualmente, attraverso un volantino azionato dall'operatore, che può controllarne la velocità. Il filo corto garantisce una maggiore resistenza meccanica e consente quindi di tagliare in porzioni precise anche gli impasti più duri o congelati. Facile da pulire, questo strumento non richiede alcuna manutenzione.

Ideal for cutting cremeni and ganache with dried fruit or hard products and small pastries even at low temperature. The advancement of the work table is done manually, through a handwheel operated by the user, who can control its speed. The short wire guarantees greater mechanical resistance and therefore allows even the hardest or frozen dough to be cut into precise portions. Easy to clean, this tool does not require any maintenance.



Struttura e telai in alluminio
Structure and frames in aluminum

Manopola di avanzamento grande per permettere un taglio più preciso e delicato

Large hand wheel to allow a more precise and delicate cut

Base di avanzamento asportabile per una migliore pulizia

Removable base for better cleaning

Inserimento dei telai ad incastro
Frame insertion by interlocking

Parti ricambio - Spare parts

Piatto Inox
Steel Sheet
CSM0602
X CSM060 BIG

Spatola
Spatula
CSMSPB60
X CSM060 BIG

Piatto Inox
Steel Sheet
CSM0402
X CSM040 SMALL

Spatola
Spatula
CSMSPB40
X CSM040 SMALL

Chiavi di fissaggio
Spanners
CHITRIC 8

Filo Inox
Inox wire
CHITRIC 9

Inclusi nella confezione delle basi: 1 piatto inox - 1 racla PST - 2 chiavi per il fissaggio fili.
Included in the package: 1 stainless steel plate - 1 plastic spatula - 2 keys for wire fixing.



Ideali per tagliare **cremini e ganache con frutta secca o prodotti duri** e piccola pasticceria **anche a bassa temperatura**. L'avanzamento del piano di lavoro avviene manualmente, attraverso un volantino azionato dall'operatore, che può controllarne la velocità per permettere un taglio più preciso e delicato. Il filo corto garantisce una maggiore resistenza meccanica e consente quindi di tagliare in porzioni precise anche gli impasti molto duri o congelati. I telai ad incastro sono smontabili velocemente per agevolare le operazioni di pulizia e manutenzione e sono **forniti separatamente** in base alle esigenze del singolo operatore.

Ideal for cutting **cremini and ganache with dried fruit or hard products** and small pastries even **at low temperature**. The advancement of the work table is done manually, through a handwheel operated by the user, who can control its speed to allow a more precise and delicate cut. The short wire guarantees greater mechanical resistance and therefore allows even very hard or frozen dough to be cut into precise portions. The interlocking frames can be quickly disassembled to facilitate cleaning and maintenance operations and the frames are **supplied separately** according to the needs of the individual operator.

CSM060

PIANO DI TAGLIO
CUTTING SURFACE

60X60CM

TELAJ NON INCLUSI.
FRAMES NOT INCLUDED.

Misura chitarra chiusa
Closed guitar size:
73x103 h30 cm
Misura apertura massima
Maximum open size:
73x167 cm



CSM040

PIANO DI TAGLIO
CUTTING SURFACE

40X40CM

TELAJ NON INCLUSI.
FRAMES NOT INCLUDED.

Misura chitarra chiusa
Closed guitar size:
53x83 h30 cm
Misura apertura massima
Maximum open size:
53x126 cm

60X60CM

TELAJ - FRAMES

- 10 MM - CSM06001
- 15 MM - CSM06002
- 20 MM - CSM06003
- 25 MM - CSM06004
- 30 MM - CSM06005
- 35 MM - CSM06006
- 40 MM - CSM06007
- 50 MM - CSM06008
- 60 MM - CSM06009



40X40CM

TELAJ - FRAMES

- 10 MM - CSM04001
- 15 MM - CSM04002
- 20 MM - CSM04003
- 25 MM - CSM04004
- 30 MM - CSM04005
- 35 MM - CSM04006
- 40 MM - CSM04007
- 50 MM - CSM04008
- 60 MM - CSM04009

PERFECT LAYERS

Stratificazione perfetta! Telai precisi e facili da usare per creare cremini, ganache e gelatine di frutta multi-strato con pesi ed altezze sempre costanti.
Perfect layering! Precise and easy to use frames to create creamini, ganaches and multi-layer fruit jellies with constant weights and heights.

BIG

Inclusi nella confezione: 1 Base polietilene - 1 spatola in plastica - 2 telai h5mm - 2 telai h3mm
Included in the package: 1 polyethylene base - 1 plastic spatula - 2 frames h5mm - 2 frames h3mm

TL SPECIAL

MISURA INTERNA
INTERNAL SIZE

36,5X36,5CM

2+2 QUADRI INCLUSI.*
2+2 FRAMES INCLUDED.*

Parti ricambio - Spare parts

* h 3 mm

TLS03

365x365 mm

* h 5 mm

TLS05

365x365 mm

* Raplette in plastica

Plastic spatulas

SPB - 555 h80 mm



MINI

Inclusi nella confezione: 1 Base polietilene - 1 spatola in plastica - 2 telai h5mm - 2 telai h3mm
Included in the package: 1 polyethylene base - 1 plastic spatula - 2 frames h5mm - 2 frames h3mm

TLMINI

MISURA INTERNA
INTERNAL SIZE

24X24CM

2+2 QUADRI INCLUSI.*
2+2 FRAMES INCLUDED.*

Parti ricambio - Spare parts

* h 3 mm

TLM03

240x240 mm

* h 5 mm

TLM05

240x240 mm

* Raplette in plastica

Plastic spatulas

SPBMINI - 270x65 mm



SINGLE FRAMES

Telai singoli per creare precise stratificazioni in cioccolato, biscuit e altri impasti in modo semplice e veloce.
Single frames to produce perfect layers in chocolate, biscuit and other doughs in easy and fast way.

SPACE SAVER

MISURA INTERNA
INTERNAL SIZE

36X36CM

h 3 mm - QG 3

h 5 mm - QG 5



FIXED FRAMES

MISURA INTERNA
INTERNAL SIZE

36X36CM

h 10 mm - QG 10

h 15 mm - QG 15

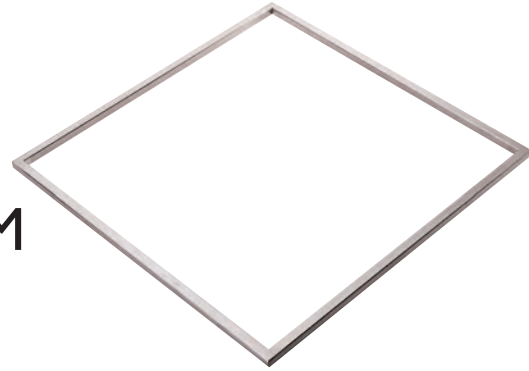

PLASTIC FRAMES

MISURA INTERNA
INTERNAL SIZE

37X57CM

h 3 mm - TL 03

h 4 mm - TL 04

h 5 mm - TL 05

Misura esterna
External Size: 47x67 cm



CHARLOTTE FRAME

MISURA INTERNA
INTERNAL SIZE

38X58CM

h 15 mm - TL 15

Misura esterna
External Size: 39x59 cm



RAPLETTE

La raplette regolabile consente di stendere e livellare in modo veloce, preciso ed uniforme impasti morbidi e cioccolato, anche multi-strato. Realizzata in resistente acciaio inox, conferisce al prodotto le dimensioni desiderate. La larghezza massima di stesura è 40 cm, lo spessore è variabile da 0.1 a 1.8 cm.

The adjustable raplette allows to spread and level in a fast, precise and uniform way soft dough and chocolate, even multi-layer. Made of resistant stainless steel, it gives the product the desired dimensions. The maximum spreading width is 40 cm, the thickness is variable from 0.1 to 1.8 cm.

SPB SPECIAL

MISURA MASSIMA
MAXIMUM SIZE

40CM

Misura esterna - External size
50x18 h 6cm



SPINNER

E-Turning Cake

L'indispensabile giratorta elettrico per il tuo laboratorio
Electric Cake Turntable: an essential tool for your laboratory



Composto da un **corpo stabile** con trascinatore circolare sul quale ruota un **piano perfettamente planare** in plexiglass, con **scala graduata** in cm ed inch, consente il corretto e costante posizionamento del prodotto e la misurazione del decoro.

The cake turntable is composed by a **stable base** with circular guide and **planar Plexiglas plate**, with **graduated scale** for the correct and constant positioning of the product and the measurement of the decoration.

Con il regolatore puoi **variare la velocità** e il **senso di rotazione**. I **led direzionali** indicano il senso di rotazione ed in base all'intensità la velocità. Il pratico tappetino in silicone antiscivolo garantirà maggiore stabilità durante la lavorazione.

The regulator allow to **vary speed** and **direction of rotation**. **LEDs indicate direction** and speed of rotation. The practical non-slip silicone mat will ensure greater stability during processing.

Il giratorta elettrico: compatto, pratico e leggero, che semplifica e aiuta il tuo lavoro.

The electric turning cake: compact, practical and light, that simplifies and helps your work.

SPINNER

Misure / Size: 27x26 h 12 cm

Peso / Weight: 1,6 Kg

MADE IN ITALY



Regolatore di velocità

Speed regulator

Anello trascinatore circolare

Roller ring support

Piatto in plexiglass e tappeto in silicone
Plexiglass plate and silicone mat

Piatto con scala graduata da 60 a 220 mm

Graduated plate between 2,36 and 8,66 inch

Luminosità LED proporzionale alla velocità

LED brightness proportional to speed

Rotazione oraria ed antioraria
Clockwise and anti-clockwise rotation



GIRATORTA - CAKE TURNTABLE

GIRA5 - Ø29cm
Giratorota in lega di alluminio, resistente e planare.

Aluminum alloy cake turntable, resistant and flat.

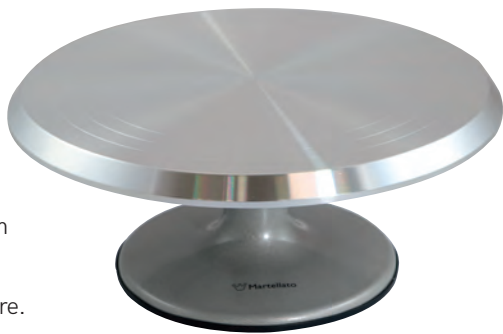

High quality

GIRA6 - Ø30cm
Giratorota professionale in lega di alluminio anodizzato, resistente alle abrasioni, agli acidi e facile da pulire.

Professional cake turntable in anodised aluminium alloy, resistant to abrasion, acids and easy to clean.



Inclinabile - Tilting

40-W125 - Ø23 h14cm

Plastica - Plastic

Giratorota inclinabile, fino a 20°, con tappeto antiscivolo per mantenere stabile e in posizione i dolci.

Tilting cake turner, up to 20°, with non-slip mat to keep cakes stable and in position.



Giratorota in plastica, semplici e leggeri. Economici, sono strumenti che non possono mancare in pasticceria.

Plastic cake turntable, simple and light. Cost-effective, these tools are a must have in any pastry shop.



Plastica - Plastic
GIRA - Ø32 h10cm



Plastica - Plastic
GIRA7 - Ø30,4 h3,2cm

PALA PER DOLCI - CAKE LIFTER

Pala per dolci che rende facile lo spostamento di torte, crostate, pane e articoli da forno.
Cake Lifter for easy handling and moving of a whole cakes, tarts, pastry, bread and bakery items.

Acciaio inox - Stainless steel

TS1
Ø28 cm



STENDI PASTA - ROLLING MACHINE

La stendi pasta permette una grande economia di tempo e soprattutto non necessita di personale specializzato per operare. È stata ideata e realizzata per risolvere i problemi di formatura dei dischi per la preparazione di pizze, pane, focacce, tortine, ecc. La macchina lavora a freddo e non altera le caratteristiche della pasta.

La stendi pasta è di semplice utilizzo e offre una qualità costruttiva di altissimo livello.

Selezionare gli spessori per l'impasto finale è un'operazione rapida ed intuitiva.

The rolling machine allows a great economy of time and above all it does not require specialised personnel to operate. It is designed and manufactured to solve the problems of forming discs for the preparation of pizzas, bread, focaccia, cakes, etc.. The machine works cold and does not alter the characteristics of the dough.

The rolling machine is easy to use and offers the highest level of construction quality.

Selecting the thicknesses for the final dough is a quick and intuitive operation.

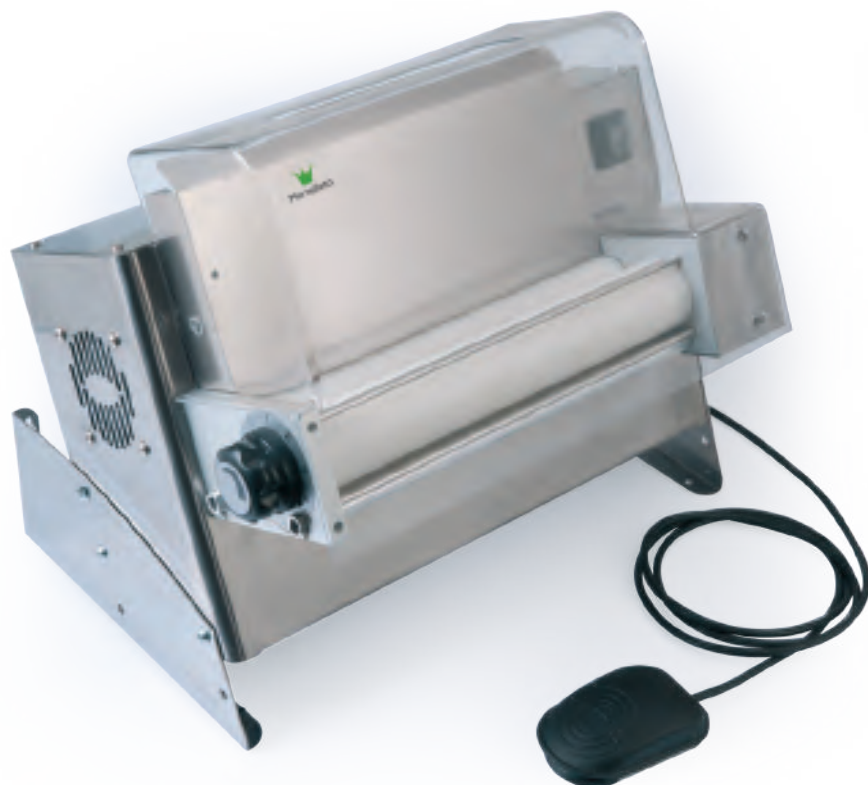

31 CM

LUNGHEZZA RULLO
ROLLER LENGTH

40-W200

Ingombro totale - Total overall size:
45x35,5 - h37,5cm

50 CM

LUNGHEZZA RULLO
ROLLER LENGTH

40-W20045

Ingombro totale - Total overall size:
65x35,5 - h37,5cm

Scocca di protezione: protezione dei rulli in plexiglass trasparente per la massima sicurezza, senza alterare la visibilità.

Protective Shell: transparent plexiglass roller protection for maximum safety, without altering visibility.

Monorullo in teflon
Teflon single roller

Manopola per la regolazione del spessore
Thickness adjuster knob

1 • 2 • 3 • 4 mm



Potenza motore monofase: KW 0,25 - Alimentazione: 230 1ph 50Hz
Single-phase motor power: KW 0,25 - Power supply: 230 1ph 50Hz

EASY COVERS

IL SISTEMA PIÙ COMPLETO PER CONSERVARE I TUOI PRODOTTI
THE MOST COMPLETE SYSTEM TO PROTECT YOUR PRODUCTS

MADE IN ITALY



LEGGEREZZA

Realizzati in materiale plastico di alta qualità, sono ultra leggeri e facili da trasportare

LIGHTNESS

Made of high quality plastic material, they are ultra-light and easy to transport

RESISTENZA

Infrangibili, indeformabili e con elevata elasticità, resistono agli urti anche a bassissime temperature

RESISTANCE

Unbreakable, non-deformable and with high elasticity, they resist to impact even at very low temperatures



PROTEZIONE

La superficie trasparente ed opalescente protegge dalla luce e consente di vedere il prodotto all'interno

PROTECTION

The opalescent and transparent surface protects from light and allows you to see the product inside





COPERCHI E VASSOI IN DIVERSE ALTEZZE E MISURE PER STOCCARE E PROTEGGERE LE VOSTRE CREAZIONI

COVERS AND TRAYS OF DIFFERENT HEIGHTS AND SIZES TO STORE AND PROTECT YOUR CREATIONS

COPERCHI E VASSOI
LIDS AND TRAYS

Size cm	Code
59,5x39,5 h 4,2	VC60X404
59,5x39,5 h 6,2	VC60X40
59,5x39,5 h 8,2	VC60X408
30x40 h 6,2	VC30X40

COPERCHI
LIDS

Size cm	Code
59x39 h 4	COVER 3H4
59x39 h 4,5	COVER3H45
59x39 h 4,8	COVER3H48
59x39 h 6	COVER 3
59x39 h 8	COVER 8
30x40 h 6	COVER 4

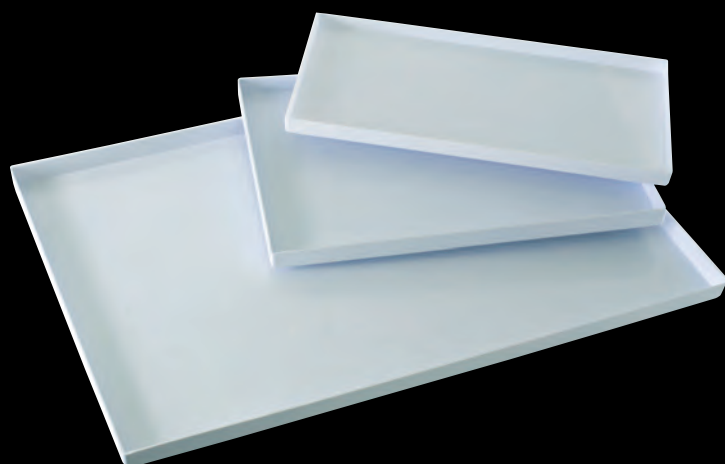

VASSOI
TRAYS

Size cm	Code
59,8x39,6 h 2	VASSOIOCMO
39,5x29,8 h 2	VASSOIOBMI

ALTRE MISURE
OTHER SIZE

Size cm	Code
59x39,6 h 2,5	VASSOIOCM1
39,5x17,3 h 2	VASSOIOAMO
44x20 h 2	VASSOIOAMI
39,5x25,8 h 2	VASSOIOBMO

CHEF WHIP

Sifone per panna Cream whipper

Lo Chef Whip è adatto per la preparazione veloce di panna montata, spugne mousse, dolci, schiume fredde e salse calde e fredde, oltre ad essere ideale per guarnire cappuccini, caffè, dolci e gelati.

The Chef Whip is suitable for the quick preparation of whipped cream, mousse sponges, sweets, cold foams and hot and cold sauces, as well as being ideal for garnishing cappuccinos, coffee, sweets and ice creams.



Il kit comprende: bottiglia, testata, 3 beccucci e porta capsule in acciaio. Guarnizione di testata in silicone.

The kit includes: bottle, head, 3 spouts and steel capsule holder. Silicone head gasket.

500 ml

50SI01

Sifone per panna
Cream whipper

1000 ml

50SI02

Sifone per panna
Cream whipper

 **Martellato**



RICARICHE PER SIFONE CREAM CHARGES

50SIRO1

Cartucce per sifone panna NO2
NO2 cream whipper cartridges
Pack 10 pcs

PISTON FUNNEL

Dosatori professionali in acciaio inox ideale per dosare piccole quantità di prodotto nei bicchierini o negli appositi stampi, in modo **facile e senza sprechi**. Ottimo per salse, gelatine, crème brûlée e marmellate liquide, è fornito di un set di bocchette per una migliore applicazione.

Professional stainless steel funnel ideal for dosing small quantities of product in small cups or in the suitable moulds, in an **easy and waste-free way**. Excellent for sauces, jellies, crème brûlée and liquid jams, it is equipped with a set of nozzles for a better application.



50CO001 - 800 ml

Colino professionale completo: la confezione comprende un piedistallo in metallo e tre bocchette da \varnothing 2 - 4 - 5 mm.
Complete professional funnel: packaging includes a metal support and three nozzles: \varnothing 2 - 4 - 5 mm.

50CO002 - 1900 ml

Colino professionale completo: la confezione comprende un piedistallo in metallo e tre bocchette da \varnothing 4 - 5 - 6 mm.
Complete professional funnel: packaging includes a metal support and three nozzles: \varnothing 4 - 5 - 6 mm.

GRIGNOTTINA - COOKIES MAKER

Dosatrice per creare velocemente ed in modo preciso "grignottes", biscotti e altri impasti.
Composto da: 1 telaio in plastica senza fondo - 2 teglie forate (Ø30 - 40 mm) - 1 spatola in plastica

Dosing tool to quickly and precisely create "grignottes", biscuits and other doughs.
Composed of: 1 plastic saucepan without bottom - 2 perforated trays (Ø30 - 40 mm) - 1 plastic spatula

CIOK 1
60x40 h5 cm



PALLINATORE - BALL MACHINE

Strumento ideale per la produzione di "Baci di Dama", praline e palline di marzapane.
Ideal tool for the production of "Lady's Kisses", pralines and marzipan balls.

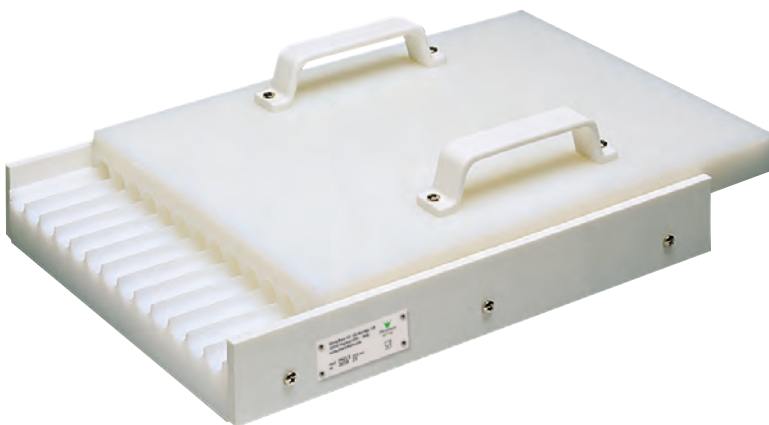

Ø 1,6 CM
PALL1

Ø 1,9 CM
PALL2

Ø 2,4 CM
PALL3



BILANCE - SCALES

Precise e facili da usare: pannello touch, funzione tara, indicazione di sovraccarico, indicatore di bassa potenza.
Precise and easy to use: touch panel, tare function, overload indication, low power indicator.



Bilancia piccola - Small scale
50BI01

Superficie in vetro temperato
Tempered glass surface
Div 1g - 0,05oz / 1ml (1/8cup) - max 5 Kg
Batterie incluse - Batteries included
Misura - Size: 22x16 cm



Bilancia grande - Big scale
50BI02

Superficie in acciaio inossidabile
Stainless steel surface
Div 1g - 0,05oz - max 15 Kg
Batterie incluse - Batteries included
Misura - Size: 26x31 cm

TERMOMETRI - THERMOMETERS

Termometri digitali con sonda o ad infrarossi precisi e funzionali.
Precise and functional thermometers with probe or infrared technology.



Termometro elettronico
Electronic thermometer
50T001

Sonda ad immersione
Dipping probe
Celsius -50°C / 300°C
Fahrenheit -58°F / 572°F



Termometro ad infrarossi
Infrared thermometer
50T002

LCD display
Celsius -50°C / 420°C
Fahrenheit -58°F / 788°F



Termometro digitale
Digital thermometer
50T003

Sonda ad immersione - Display e Timer
Dipping probe - Display and Timer

Celsius 0°C / 250°C
Fahrenheit -32°F / 482°F

CONTAINERS

ISOTHERMAL

GASTRONORM

50CI210GN - Cap. 38,6 Lt
Internal size: 540x340x210 mm
External size: 600x400x270 mm

50CI280GN - Cap. 52,3 Lt
Internal size: 540x340x280 mm
External size: 600x400x340 mm

MAXI 60X40

50CI316040 - Cap. 82,3 Lt
Internal size: 625x425x310 mm
External size: 685X485X370 mm

50CI276040 - Cap. 71,7 Lt
Internal size: 625x425x270 mm
External size: 685X485X330 mm

50CI086040 - Cap. 21,3 Lt
Internal size: 625x425x80 mm
External size: 685X485X140 mm

50CI216040 - Cap. 55,8 Lt
Internal size: 625x425x210 mm
External size: 685X482X270 mm

50CI166040 - 42,5 Lt
Internal size: 625x425x160 mm
External size: 685X485X240 mm



coperchio incluso
cover included



Piastra eutettica
Eutectic plate
- 12°C / 0°

50CIA005
Size: 530x325x30 mm
x GASTRONORM

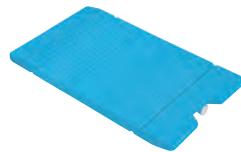

Piastra eutettica
Eutectic plate
- 6°C / 0°C

50CIA008
Size: 380x215x30 mm
x GASTRONORM
x MAXI



Inserto Caldo&Freddo
Hot&Cold system insert

50CIA006
Size: 695x495x100 mm
x MAXI



Carrello plastica
Plastic trolley

50CIA003
Size: 610x410 mm
x GASTRONORM

50CIA007
Size: 600x400x30 mm
x MAXI



GASTRONORM

50CI540GN - Cap. 83 Lt
Internal size: 540x330x480 mm
External size: 650x500x610 mm

MAXI 60X40

50CI6040 - Cap. 128,1 Lt
Internal size: 600x400x500 mm
External size: 720x600x630

Supporti salva guida
Wire rail bracket

50CIA002
for 50CI6040
MAXI
kit 9pcs

ISOTHERMAL RING SYSTEM

50X50

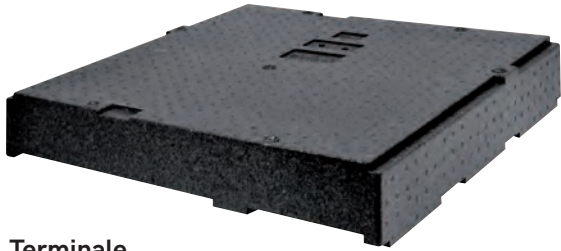

**Terminale
End piece**

50CI5050BC

Internal size: 510x510x63 mm
External size: 570x570x95 mm



**Estensore
Extensor**

50CI5050ES

Internal size: 510x510x95 mm
External size: 570x570x95 mm



PLASTIC BOX



Casse milleusi - Multipurpose crates

Casse forate, inseribili e sovrapponibili.
Insertable and stackable perforated crates.

50CA5543F

Cap. 50 Lt - 5x43 h 31

50CA6344F

Cap. 65 Lt - 63x44 h 34

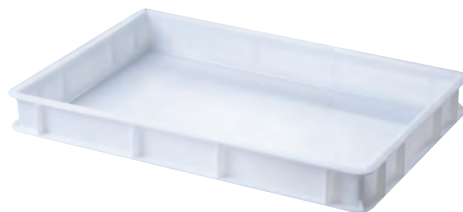

**Cassa fondo chiuso senza maniglie
Closed bottom case without handles**

50CA604007C

Cap. 12 Lt - 60x40 h 7

50CA604010C

Cap. 18 Lt - 60x40 h 10

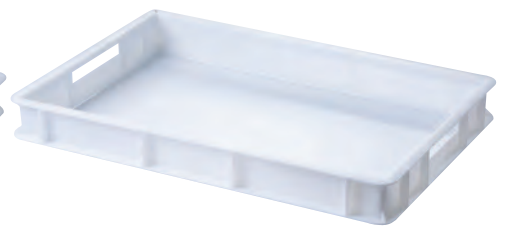

**Cassa fondo chiuso con maniglie
Closed bottom case with handles**

50CA604013C

Cap. 24 Lt - 60x40 h 13



**Coperchio per casse milleusi
Multipurpose crate lids**

50CA50COP

55x43 cm

50CA65COP

63x44 cm



**Coperchio per casse 60x40
Crate lid 60x40**

50CA6040COP

60x40 cm

MACARON DISPLAYS



MACARON

Espositori in plexiglass per macaron.
Plexiglass displays for macarons.

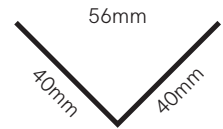

AG05801

315x325 h65 mm
5 file / rows - cap. 50 pcs approx



AG05701

460x330 h145 mm
7 file / rows - cap. 70 pcs approx



AG05601

270x330 h145 mm
4 file / rows - cap. 70 pcs approx



AG07801

270x150 h480 mm
cap. 25 pcs



AG07901

350x350 h450 mm
cap. 60 pcs



AG08201

400x350 h280 mm
cap. 15/18 pcs



AG07701

Ø280 h430 mm
cap. 62 pcs



AG07701P

Ø240 h 280 mm
cap. 30 pcs



AG08101

55x350 h600 mm
cap. 9 pcs

DISPLAY CASES





Vetrina con porta - Display with door

VB00900 bianco - white

49,5x37,5 h52 cm - 2 piani - shelves



Vetrina con porta - Display with door

VB00904 rosso - red

49,5x37,5 h52 cm - 2 piani - shelves



Vetrina con porta - Display with door

VB00908 nero - black

49,5x37,5 h52 cm - 2 piani - shelves



Vetrina con 2 ripiani e porta
Display with 2 shelves and door
VB00802

31,5x30,5 h.30,5 cm - 2 ripiani/shelves
 distanza fra i piani/shelves distance h.16 cm



Vetrina con 3 ripiani e porta
Display with 3 shelves and door
VB00804

31,5x30,5 h.45 cm - 3 ripiani/shelves
 distanza fra i piani/shelves distance h.16 cm



Vetrinetta multiuso
Multi-function display
VB00803

37x31 h.32,5 cm - 2 ripiani/shelves
 distanza fra i piani/shelves distance h.15 cm
 Ideale per esporre coni e brioche
 Ideal to display cones and brioches



Vetrina 1 porta
Display with 1 door

VB00306 - 41x36,5 - h44 cm
 3 piani inclinati - inclined shelves 11cm



Vetrina con 1 porta
Display with 1 door
VB00408 - 37x31 - h31 cm
 3 piani/shelves 10cm



Vetrina a LED - 3 piani inclinati e porta
LED display - 3 inclined shelves & door
VB00308 - 39,5x32,5 - h50,5



Vetrina con 3 piani inclinati e porta
Display with 3 inclined shelves and door
42x31 h 42,5 - 27,5x39,5cm

VB00200 Bianco - White

VB00201 Trasp. - Trans.

VB00202 Verde - Green

VB00203 Arancio - Orange

VB00206 Satinato - Satin

VB00208 Nero - Black



Vetrina con 2 vassoi e porta
Display with 2 trays and door

AR02801 - 49,5x31 - h27 cm

1 lato aperto - 2 cassetti

1 open side - 2 drawers

Misure personalizzabili su richiesta

Measures can be changed on request



Proteggi brioches
Plexiglass food shields

Misure personalizzabili su richiesta
Measures can be changed on request

AR0001 - 49,5x30 - h27 cm

AR00011 - 99,5x30 - h27 cm



Con battuta 4 cm - With 4cm batting

AR0001B - 49,5x30 - h27 cm

AR00011B - 99,5x30 - h27 cm

VETRINE - DISPLAY CASES



Vetrina con 2 ripiani e 4 porte
Display with 2 shelves and 4 doors

VB00102 - 60x37 h 40cm
 4 porte su due lati - 4 doors on two sides

VB00102B - 60x37cm - h40cm
 2 porte su un lato - 2 door on a side



Vetrina con 2 ripiani e 2 porte
Display with 2 shelves and 2 doors

VB00501 - 2 piani/shelves
 50x38 h45,5 cm



Vetrina con base in acciaio
Display with stainless steel base

VB00107 - 1 piano-shelf
 35 x 49,5 h 33 cm

VB00109 - 2 piani - shelves
 35 x 49,5 h 39 cm

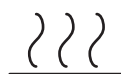

Vetrina con base in acciaio riscaldante
Display with heating stainless steel base

Base in acciaio/ St. steel base
 Max 40°C - Apertura 2 lati/Door on 2 sides

VB00110 - 2 piani-shelves
 35x49,5 h 39 cm

VB00108 - 1 piano-shelf
 35x49,5 h 33 cm



Vetrina con bordo a specchio
Display with mirror frame

VB00701 - 31x25,5cm - h52cm
 3 piani e porta - 3 shelves and door
 h tra i piani/distance between floors 14 cm

Vetrina con 2 ripiani e doppia porta
Display with 2 shelves - double doors

VB00104 - 67x40cm - h53cm
VB00103 - 50x33cm - h53cm



VETRINA BASSA - DISPLAY CASES



Vetrina - Display

VP00101

60x36cm - h16cm

Accessori interni non inclusi

Internal accessories not included

Vassoio - Tray

VP00401

34X11cm - h2cm



Vassoio - Tray

VP00700

18X29cm - h2,5cm



Piatto - Plate

VP00501

32X9cm - h0,2cm

VP00801

13X24cm - h0,2cm

Praline mini display

COD. 604

22x27 h30 cm



Alzata 5 piani - 5 plates display

COD. 605

piani/plates: ø 36, 28, 20, 12, 5 - h27cm

altezza tra i piani 5 cm - height between plates 5 cm



PIATTI DA ESPOSIZIONE DISPLAY PLATES



Vassoio - Tray

VP00500

32x20cm - h2,5cm

Piatto - Plate

VP00601

26x15cm - h0,2cm



Vassoio - Tray

VP00206

17x17cm - h2cm

Piatto - Plate

VP00301

16,5x16,5cm - h0,2cm



Vassoio - Tray

VP01106

17x23cm - h2cm

Piatto - Plate

VP01201

16,5x22,5cm - h0,2cm

Vassoio - Tray

VP00906

10x50cm - h2cm

Piatto - Plate

VP01001

9,5x49,5cm - h0,2cm



VASSOI PLEXIGLASS - PLEXIGLASS TRAYS

LITTLE DECORO

145 x 400 h 20 mm

Colore - Color	Code
Bianco - White	50VP0100
Nero - Black	50VP0108

145 x 289 h 20 mm

Colore - Color	Code
Bianco - White	50VP0200
Nero - Black	50VP0208



204 x 258 h 20 mm

Colore - Color	Code
Bianco - White	50VP0300
Nero - Black	50VP0308

294 x 394 h 20 mm

Colore - Color	Code
Bianco - White	50VP0400
Nero - Black	50VP0408

MODERN STYLE

145 x 400 h 20 mm

Colore - Color	Code
Bianco - White	50VP0500
Nero - Black	50VP0508

145 x 289 h 20 mm

Colore - Color	Code
Bianco - White	50VP0600
Nero - Black	50VP0608



204 x 258 h 20 mm

Colore - Color	Code
Bianco - White	50VP0700
Nero - Black	50VP0708

294 x 394 h 20 mm

Colore - Color	Code
Bianco - White	50VP0800
Nero - Black	50VP0808

Su richiesta ampia gamma di colori e misure realizzabili
On request different colors and sizes



plexiglass nero - black plexiglass

Size mm	thickness	Code
600X100	5	50VP601008
600X250	5	50VP602508
250X120	5	50VP251208
200x200	5	50VP202008
250x250	5	50VP252508
200X100	5	50VP201008



vassoio plexiglass - plexiglass tray

Size mm	Code
470x340 - h50	VS00101

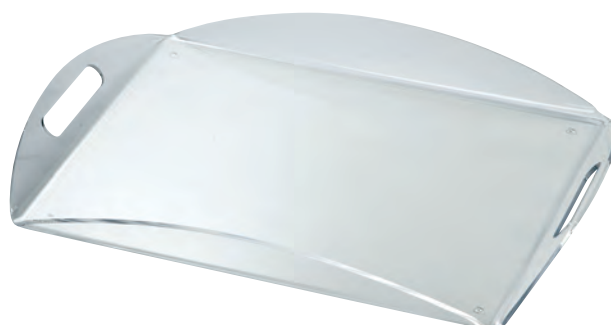

ESPOSITORI PER LA VENDITA SALES DISPLAY



Espositore in metallo
Metal display

ESPOSITORE

95x55 h210 cm
con 20 ganci inclusi
with 20 hooks included

Crowner incluso
Crowner included



Espositore in legno
Wooden display
ESPOWMONOUSO
78,5x52 h195 cm



Espositore in legno
per green poche
Standing wooden display
for green poche

ESPOWG70GP

Misura/Size:
49,4x46,5 h150 cm

Алматы (7273)495-231
Ангарск (3955)60-70-56
Архангельск (8182)63-90-72
Астрахань (8512)99-46-04
Барнаул (3852)73-04-60
Белгород (4722)40-23-64
Благовещенск (4162)22-76-07
Брянск (4832)59-03-52
Владивосток (423)249-28-31
Владикавказ (8672)28-90-48
Владимир (4922)49-43-18
Волгоград (844)278-03-48
Вологда (8172)26-41-59
Воронеж (473)204-51-73
Екатеринбург (343)384-55-89

Ижевск (3412)26-03-58
Иваново (4932)77-34-06
Иркутск (395)279-98-46
Казань (843)206-01-48
Калининград (4012)72-03-81
Калуга (4842)92-23-67
Кемерово (3842)65-04-62
Киров (8332)68-02-04
Коломна (4966)23-41-49
Кострома (4942)77-07-48
Краснодар (861)203-40-90
Красноярск (391)204-63-61
Курск (4712)77-13-04
Курган (3522)50-90-47
Липецк (4742)52-20-81

Киргизия (996)312-96-26-47

Магнитогорск (3519)55-03-13
Москва (495)268-04-70
Мурманск (8152)59-64-93
Набережные Челны (8552)20-53-41
Нижний Новгород (831)429-08-12
Новокузнецк (3843)20-46-81
Ноябрьск (3496)41-32-12
Новосибирск (383)227-86-73
Ноябрьск (3496)41-32-12
Омск (3812)21-46-40
Орел (4862)44-53-42
Оренбург (3532)37-68-04
Пенза (8412)22-31-16
Петрозаводск (8142)55-98-37
Псков (8112)59-10-37

Россия (495)268-04-70

Пермь (342)205-81-47
Ростов-на-Дону (863)308-18-15
Рязань (4912)46-61-64
Самара (846)206-03-16
Саранск (8342)22-96-24
Санкт-Петербург (812)309-46-40
Саратов (845)249-38-78
Севастополь (8692)22-31-93
Симферополь (3652)67-13-56
Смоленск (4812)29-41-54
Сочи (862)225-72-31
Ставрополь (8652)20-65-13
Сыктывкар (8212)25-95-17
Сургут (3462)77-98-35
Тамбов (4752)50-40-97

Казахстан (772)734-952-31

Тверь (4822)63-31-35
Тольяти (8482)63-91-07
Томск (3822)98-41-53
Тула (4872)33-79-87
Тюмень (3452)66-21-18
Улан-Удэ (3012)59-97-51
Ульяновск (8422)24-23-59
Уфа (347)229-48-12
Хабаровск (4212)92-98-04
Чебоксары (8352)28-53-07
Челябинск (351)202-03-61
Череповец (8202)49-02-64
Чита (3022)38-34-83
Якутск (4112)23-90-97
Ярославль (4852)69-52-93